

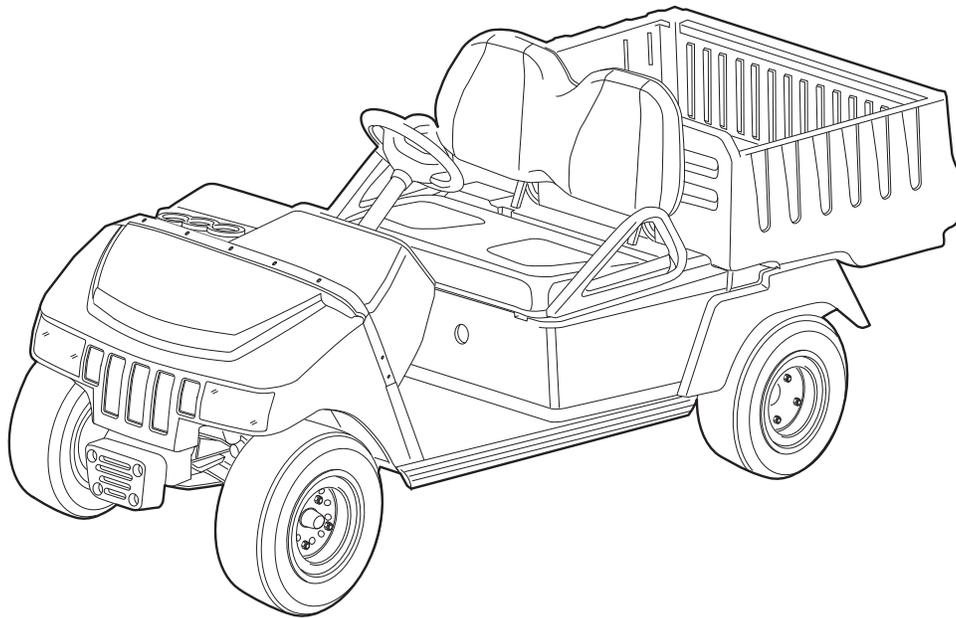

2011 XRT800/XRT810 Illustrated Parts List



Gasoline and Electric Vehicles

Manual Number 103814613
Edition Code B

USING THE ILLUSTRATED PARTS LIST

⚠ WARNING

- **This manual is to be used only for identification and ordering of service parts. Be sure to read and use the maintenance and service manual before attempting any vehicle repairs.**

The manual is divided into several sections. Each section is grouped by its relationship to the vehicle. The last section pertains to the tools that are used on all Club Car products. Note that there are flags on the outside edge of each page. The first flag contains the section number of which that page is a part. The other flags contain the letters G or E, signifying that the page pertains to either the gasoline vehicle, the electric vehicle, or both.

Use the Table of Contents to find the sections and pages that contain the parts and assemblies you seek. The Table of Contents lists section numbers, and under them, the individual page titles and numbers to be found in that section. The index can be used to find specific parts and assemblies. The index is divided into numerical and alphabetical listings with the page numbers in italic text.

There is a two-page spread for each individual page title in the Table of Contents. On the left-hand page is an illustration showing the parts in their relative positions; the parts are each tagged with an item number in a balloon. The right-hand page is the parts list page, and gives the page title at the top, then the item numbers (corresponding to the numbers on the illustration), part descriptions, and quantity of parts used.

Note that a part description may be indented. This indentation corresponds to a parts assembly level indicated by the numbers 1, 2, 3, and 4 at the top left corner of the parts description area of the parts list page. A part that is indented to *level 2* is a component of the *level 1* part (assembly) that it is listed under. A *level 3* part is a component of the *level 2* part that it is listed under, and a *level 4* part is a component of the *level 3* part preceding it. In each case, the part quantity given for a level 2, 3, or 4 part is *the quantity used per next higher level assembly of which it is a component*. A part that is not indented is a *level 1* part. This means that the quantity given is the quantity used per the portion of the vehicle illustrated on that particular spread.

HOW TO ORDER PARTS

Replacement parts and accessories can be obtained from our network of authorized dealers and distributors. You can obtain the name and phone number of your closest authorized Club Car dealer or distributor by visiting our web site at www.clubcar.com and clicking on the "Distributor Search" link or by calling our toll-free Service Parts and Technical Assistance hotline at (800) 872-2246 or (706) 863-3000, extension 3887.



P. O. Box 204658
Augusta, Georgia 30917-4658 USA
Telephone 706-863-3000
Service Parts Fax 706-855-7413
www.clubcar.com

NOTE: *This illustrated parts list represents the most current information at the time of publication. Club Car, LLC. is continually working to further improve its vehicles and other products. These improvements may affect the parts used to service the vehicle. Any modification and/or significant change in specifications will be forwarded to all Club Car and Carryall distributors/dealers and will, when applicable, appear in future editions of this illustrated parts list.*

Club Car, LLC. reserves the right to change specifications and designs at any time without notice and without the obligation of making changes to units previously sold.

Copyright © 2011 Club Car, LLC.
Club Car and *ArmorFlex*
are registered trademarks of Club Car, LLC.
This manual effective August 1, 2011.

2011 XRT800/XRT810 Gasoline and Electric Vehicles

CONTENTS

SECTION 1 – BODY AND TRIM

Front Body	1-3
Canopy Support System – To Mid-2011-Model-Year	1-5
Canopy Support System – From Mid-2011-Model-Year	1-7
Access Panel and Heat Shield	1-9
Bumper – XRT800 and XRT800-E	1-11
Brush Guard	1-13
Dash Box	1-15
Glove Box	1-17
Side Trim	1-19
Nerf Bar	1-21
Rear Body and Fender – Gasoline Vehicle	1-23
Rear Body and Fender – Electric Vehicle	1-25
Front Seat Bottom and Armrests	1-27
Seat Back	1-29
Cargo Bed	1-31
Bed Hinge	1-33

SECTION 2 – WHEELS AND TIRES

Wheels and Tires	2-3
Hubcap	2-5

SECTION 3 – DECALS

Safety Decals – Gasoline Vehicles	3-3
Safety Decals – Gasoline Vehicles, Continued	3-5
Safety Decals – Gasoline Vehicles, Continued	3-7
Logo Decals – Gasoline Vehicles	3-9
Safety Decals – Electric Vehicles	3-11
Safety Decals – Electric Vehicles, Continued	3-13
Logo Decals	3-15

SECTION 4 – LIGHTS, CONTROLS, AND INDICATORS

Headlights	4-3
Lighting System Components – XRT800/810/850 Gasoline Vehicles	4-5
Lighting System Components – XRT850 Elec. With PowerDrive Charger	4-7
Turn Signal Kit – DS and Utility Gasoline and Electric Vehicles	4-9
Reverse Buzzer	4-11
Instrument Panel – Turf/CA 1, 2, 252, and Turf 6 Gas	4-13

CONTENTS

Instrument Panel – Gasoline Vehicle	4-15
Instrument Panel – Electrical	4-17
Battery Condition Indicator – Electric Vehicles	4-19
DC Converter – IQ System Electric Vehicle	4-21
Voltage Limiter – Gasoline Vehicle	4-23
Strobe Light, Post-Mounted – Gasoline Vehicles	4-25
Strobe Light, Post-Mounted – Electric Vehicles	4-27
Strobe Light, Canopy-Mounted	4-29
Horn	4-31
Hour Meter – IQ System and IQ Plus Electric Vehicles	4-33
Taillights	4-35

SECTION 5 – BRAKE SYSTEM

Brake Pedal Assembly	5-3
Accelerator Pedal Assembly – Electric Vehicles with MCOR	5-5
Accelerator Pedal Assembly – Gasoline Vehicles	5-7
Accelerator Rod – Gasoline Vehicles	5-9
Rear Brake Assembly, Self-Adjusting – Vehicle with 2-Wheel Brakes	5-11
Brake Cables and Equalizer	5-13

SECTION 6 – STEERING AND SUSPENSIONS

Steering Wheel	6-3
Steering Column	6-5
Steering Gear Assembly	6-7
Front Suspension, Lower – Vehicles with Two-Wheel Brakes	6-9
Front Suspension, Upper	6-11
Front Spindles and Hubs	6-13
Rear Suspension	6-15

SECTION 7 – ELECTRICAL SYSTEM – GASOLINE VEHICLES

Wiring – Gasoline Vehicle	7-5
Headlights	7-7
Electrical Component Box – Gasoline Vehicle	7-9
Starter/Generator Assembly Model-G425419 – Gasoline-Vehicles	7-11
FE290 Starter/Generator Mounting – Gasoline Vehicle	7-13
FE350 Starter/Generator Mounting – Gasoline Vehicles	7-15
Battery – Gasoline Utility Vehicles	7-17

CONTENTS

SECTION 8 – FE290 ENGINE

FE290 Engine – Shrouds and Brackets	8-3
FE290 Engine – Ignition Components and Flywheel	8-5
FE290 Engine – Oil Circulation	8-7
FE290 Engine – Cylinder Head	8-9
FE290 Engine – Crankcase, Camshaft, and Oil Sensor	8-11
FE290 Engine – Crankcase and Crankshaft	8-13
FE290 Engine Mounting	8-15

SECTION 9 – AS11 FE350 ENGINE

FE350 Engine without ACR (Automatic Compression Release) – Shrouds and Brackets	9-3
FE350 Engine – Ignition-Components-and-Flywheel	9-5
FE350 Engine – Cylinder Head	9-7
FE350 Engine without ACR – Crankcase,-Camshaft,-and-Oil-Sensor	9-9
FE350 Engine – Crankcase-and-Crankshaft	9-11
FE350 Engine (AS26)- Oil Circulation	9-13
FE350 Engine (AS26)- Mounting	9-15

SECTION 10 – FUEL, INTAKE, AND GOVERNOR SYSTEMS

Fuel System	10-3
Fuel Tank with Fuel Level Sending Unit	10-5
Carburetor Assembly – FE290	10-7
Carburetor Assembly – FE350	10-9
Carburetor Installation – FE290	10-11
Carburetor Installation – FE350	10-13
Governor and Accelerator Cables	10-15
Intake Duct, Choke, and Air Box Assembly	10-17

SECTION 11 – EXHAUST SYSTEMS

Exhaust System – FE290 Engine	11-3
Exhaust System – FE350 Engine	11-5

SECTION 12 – TORQUE CONVERTER

Drive Clutch	12-3
Drive Belt – FE290	12-5
Drive Belt	12-7
Driven Clutch	12-9

CONTENTS

SECTION 13 – TRANSAXLE AND FNR SHIFTER- GASOLINE VEHICLE

Forward/Reverse Shifter Assembly – Gasoline-Vehicles	13-3
Forward/Reverse Shifter Cable – Gasoline Vehicles	13-5
Kawasaki Transaxle – Gear Cases and Brackets	13-7
Kawasaki Transaxle – F&R Transmission and Gear Reduction	13-9
Kawasaki Transaxle – Differential and Axles	13-11
Graziano Transaxle – Gear Cases and Levers	13-13
Graziano Transaxle – F&R Transmission and Gear Reduction	13-15
Graziano Transaxle -Differential and Axles	13-17
Differential Guard – Gasoline Vehicle	13-19

SECTION 14 – ELECTRICAL SYSTEM – ELECTRIC VEHICLES

Forward/Reverse Switch, Tow/Run Switch	14-3
Motor Controller Output Regulator (MCOR)	14-5
Wiring – XRT800/810 Electric	14-7
Battery Charger Receptacle	14-9
Batteries, Electric Vehicle	14-11
Computer, Controller, and Solenoid	14-13

SECTION 15 – ELECTRIC MOTOR

Motor (Model 5BC59JBS6390) – Electric Vehicle	15-3
Motor (Model EJ4-4001) – Electric Vehicle	15-5

SECTION 16 – TRANSAXLE – ELECTRIC VEHICLES

Transaxle – Electric Vehicles	16-3
Differential Guard – Electric Vehicles	16-5

SECTION 17 – BATTERY CHARGERS

PowerDrive 3 Battery Charger (Model 26580), Domestic	17-3
PowerDrive 2 Battery Charger (Model 22110), Domestic	17-5
PowerDrive Battery Charger (Model 17930), Domestic	17-7
PowerDrive Battery Charger (Model 18780), Export	17-9
PowerDrive Battery Charger (Model 20310), European	17-11

SECTION 18 – MAINTENANCE AND SERVICE TOOLS

Maintenance and Service Tools	18-3
Maintenance and Service Tools, Continued	18-5

CONTENTS

Maintenance and Service Tools, Continued	18-7
--	------

SECTION i – INDEX

BODY AND TRIM

1

G

E

1
G
E

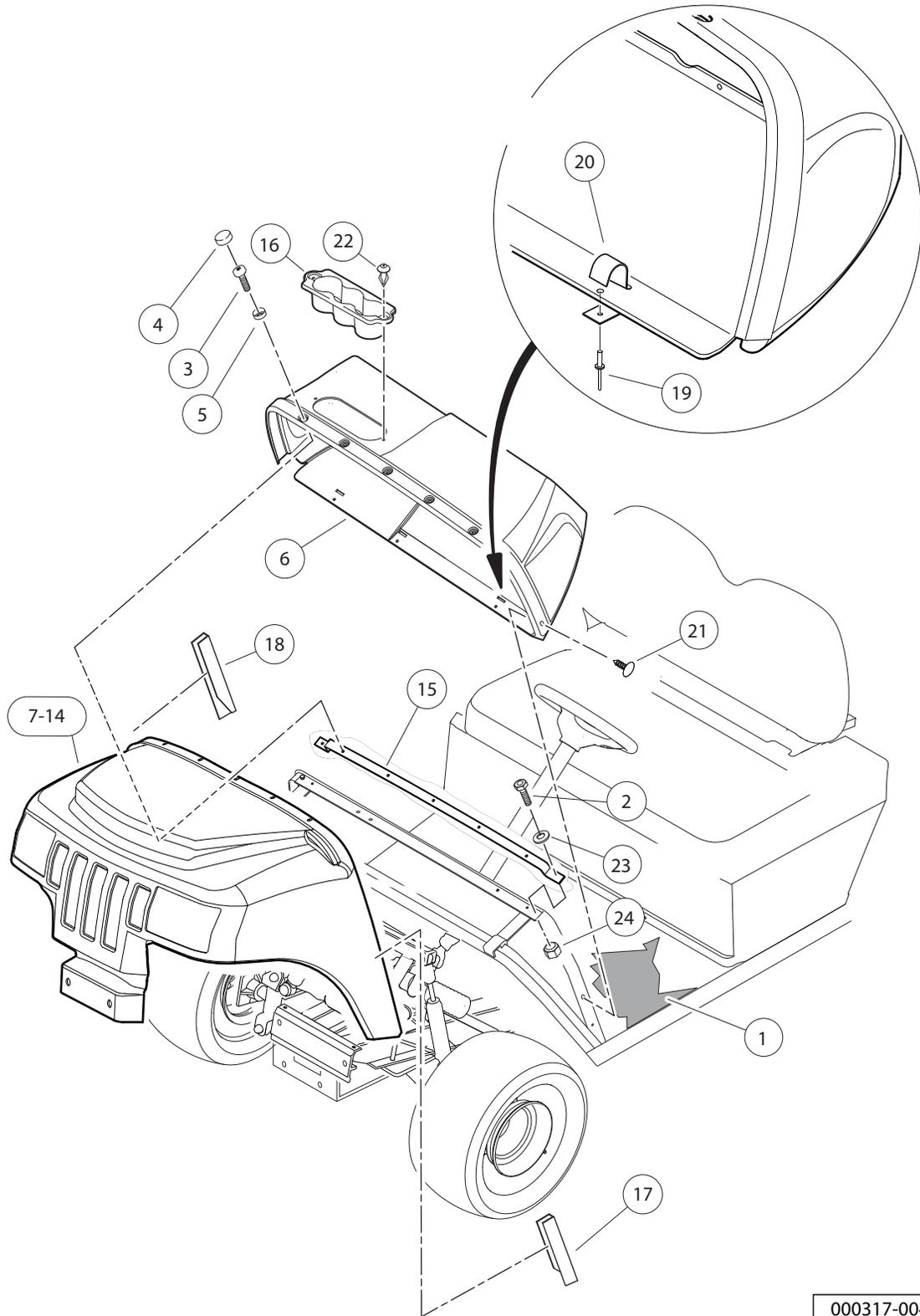

000317-004

FRONT BODY

ITEM	PART NO.	DESCRIPTION	QTY
		1 2 3 4	
1	<u>101503202</u>	Floor mat	1
2	<u>101954301</u>	Screw, 1/4-20 X 0.75 Hex-Head Cap	2
3	<u>102025801</u>	Screw, 1/4-20 X .75 Torx Pn Hd	5
4	<u>102045001</u>	Cap, 1/4" Plastic Screw Head	5
5	<u>102048401</u>	Washer, 1/4 Id Scalloped Plast	5
6	<u>102766701</u>	Dash	1
7	<u>102778501</u>	Cowl, Red	1
8	<u>102778502</u>	Cowl, Green	1
9	<u>102778503</u>	Cowl, Camouflage (Husqvarna)	1
10	<u>102778504</u>	Cowl, Classic Blue	1
11	<u>102778505</u>	Cowl, XRT- Black	1
12	<u>102778507</u>	Cowl, XRT- Camo Hard Wood HD (Standard camo for XRT850)	1
13	N/A	Cowl, XRT- Camo Max4 HD	1
14	<u>102778509</u>	Cowl, XRT- Silver	1
15	<u>102778601</u>	Support, Upper Cowl	1
16	<u>102796701</u>	Object Holder	1
17	<u>102822001</u>	Cowl Cover, Driver-Side	1
18	<u>102822002</u>	Cowl Cover, Passenger-Side	1
19	<u>102828701</u>	Rivet	10
20	<u>102857401</u>	Clip, Dash	3
21	<u>102914301</u>	Push Pin, Black	2
22	<u>102967901</u>	Rivet, Removable, Tuflok 1/4"	2
23	<u>332</u>	Washer, 1/4 Type A Narrow Flat	2
24	<u>8233</u>	Locknut, 1/4-20, Nylon Insert	2

1
G
E

1
G
E

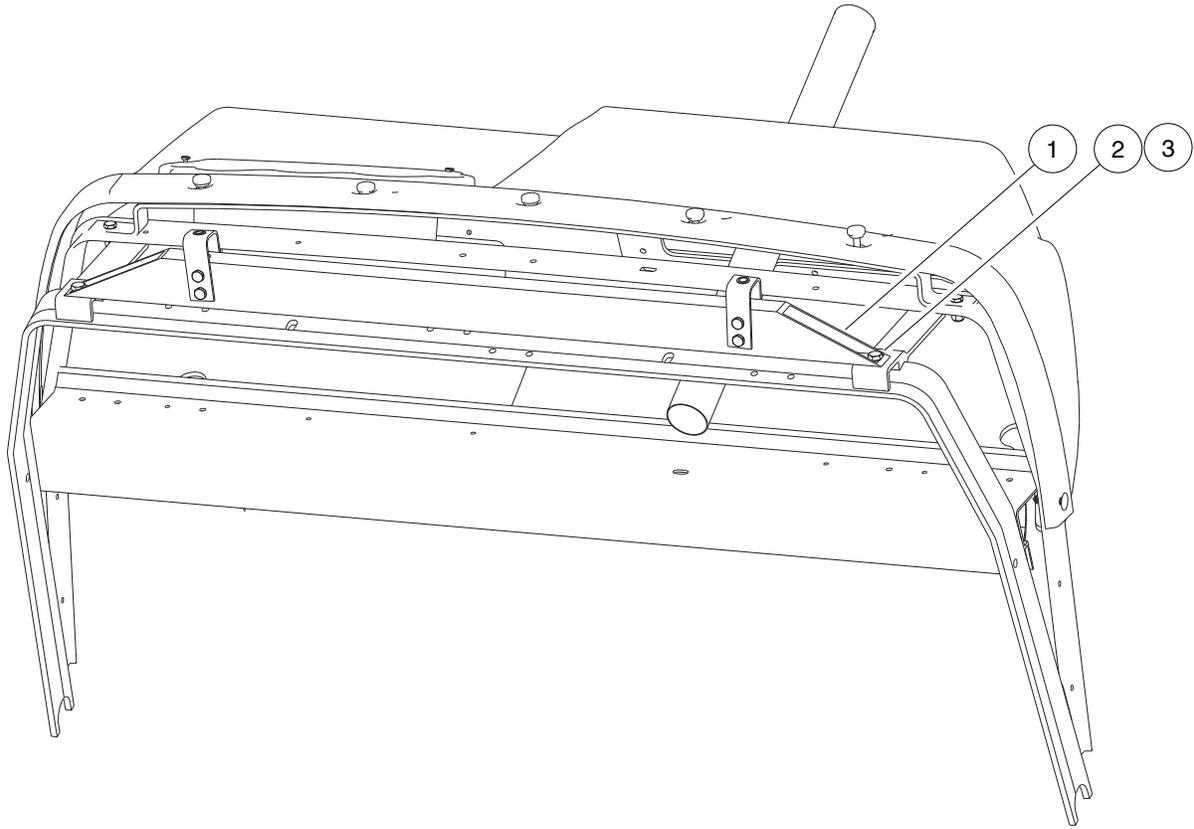

000582-003

CANOPY SUPPORT SYSTEM – TO MID-2011-MODEL-YEAR

ITEM	PART NO.	DESCRIPTION	QTY
1	<u>103313301</u>	1 2 3 4 Asm, Brace, Canopy, Tube, Xrt	1
2	<u>1241</u>	Washer, 5/16 Type A Flat	2
3	<u>7173</u>	Screw, 5/16-18 X 0.75, Hex-Head Cap	2

1
G
E

1
G
E

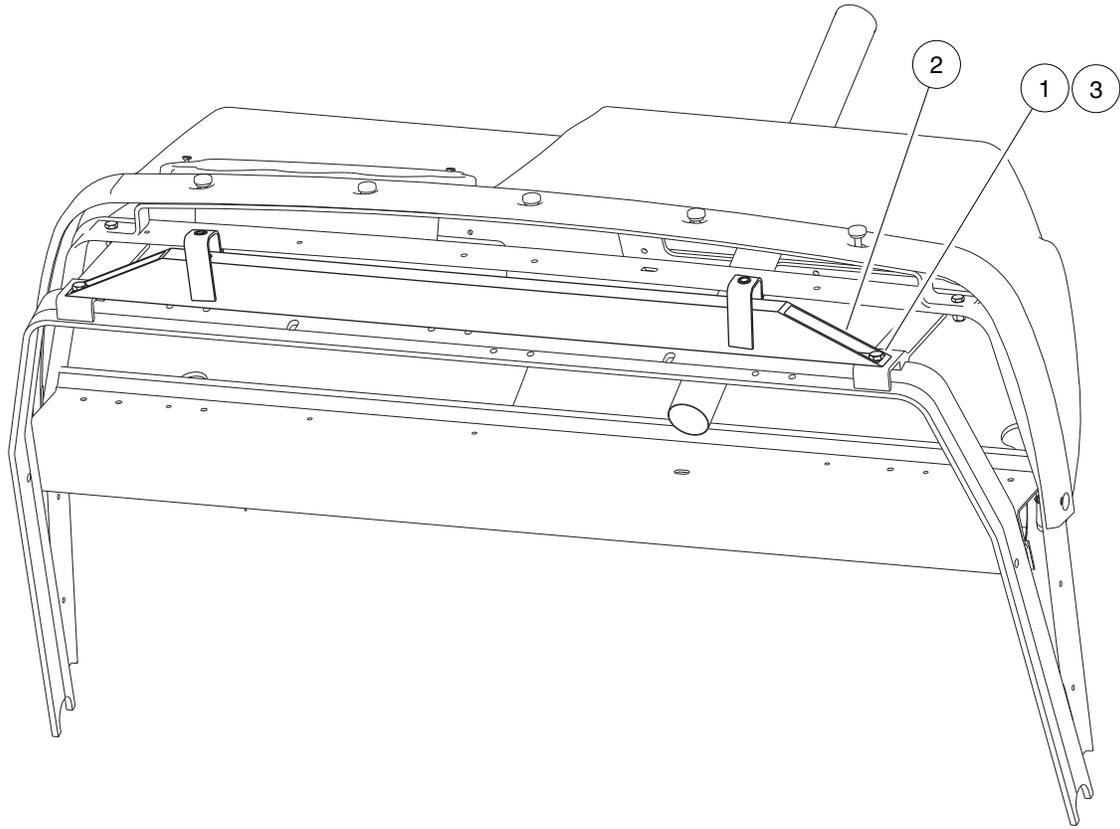

000582-001

CANOPY SUPPORT SYSTEM – FROM MID-2011-MODEL-YEAR

ITEM	PART NO.	DESCRIPTION	QTY
		1 2 3 4	
1	<u>102242101</u>	Screw, 5/16-18 X 3/4 Hex-Head with Patch	2
2	<u>103313301</u>	Asm, Brace, Canopy, Tube, Xrt	1
3	<u>1241</u>	Washer, 5/16 Type A Flat	1

1
G
E

1

G

E

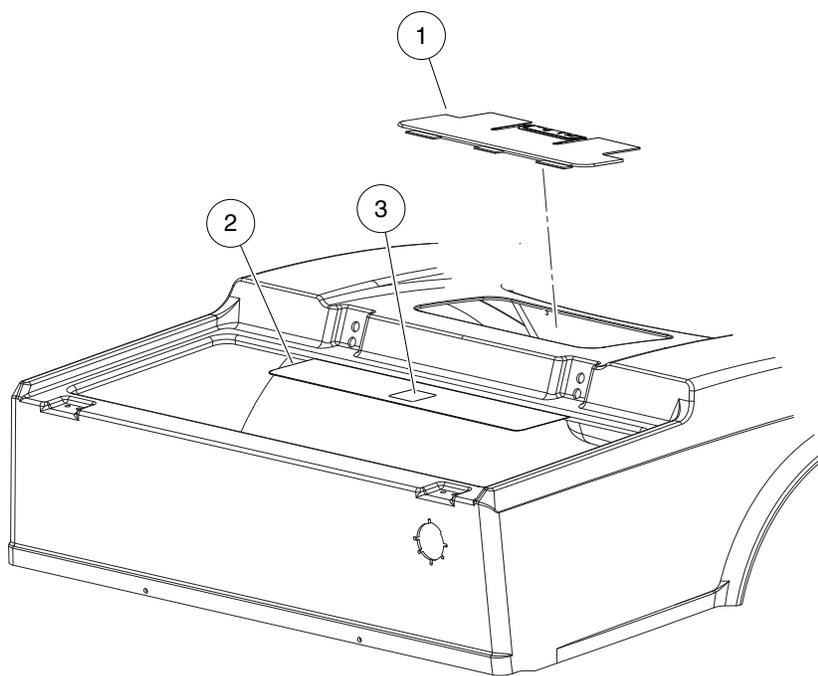

000819-002

ACCESS PANEL AND HEAT SHIELD

ITEM	PART NO.	DESCRIPTION	QTY
1	<u>101303202</u>	1 2 3 4 Access Panel - Black, Cut	1
2	<u>101806901</u>	Shield, Heat	1
3	<u>101960501</u>	Decal, Rotating Parts/Hot Manifold	1

1
G
E

1
G
E

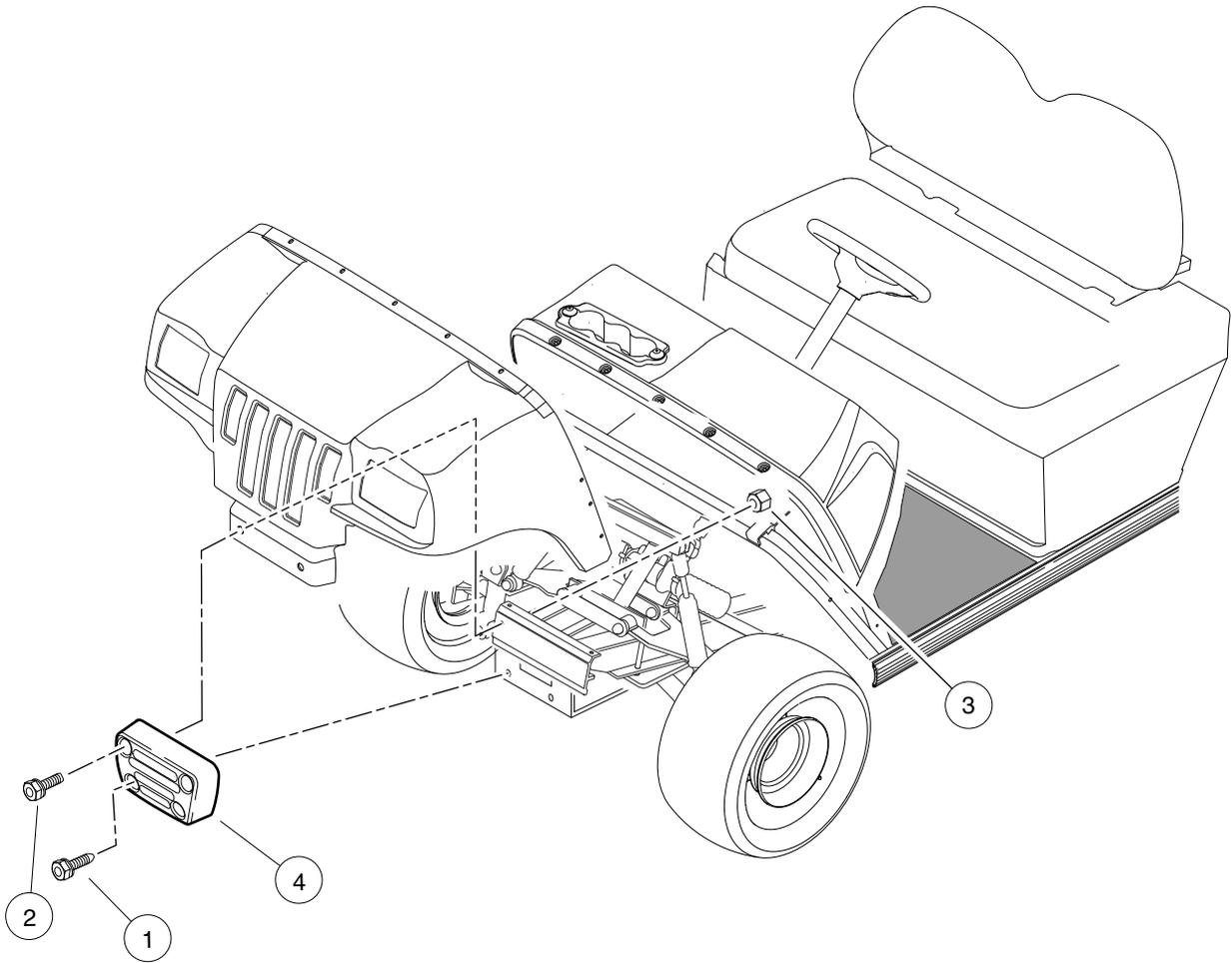

000357-002

BUMPER – XRT800 AND XRT800-E

ITEM	PART NO.	DESCRIPTION	QTY
		1 2 3 4	
1	<u>102289002</u>	Screw, M8 X 1.25 X 30 Tri, Blk	2
2	<u>102298240</u>	Bolt, Flange Head, M8-1.25 X 40	2
3	102618601	Lock Nut, Flange, M8 X 1.25 Nylon	2
4	<u>102830501</u>	Bumper, Cast	1

1
G
E

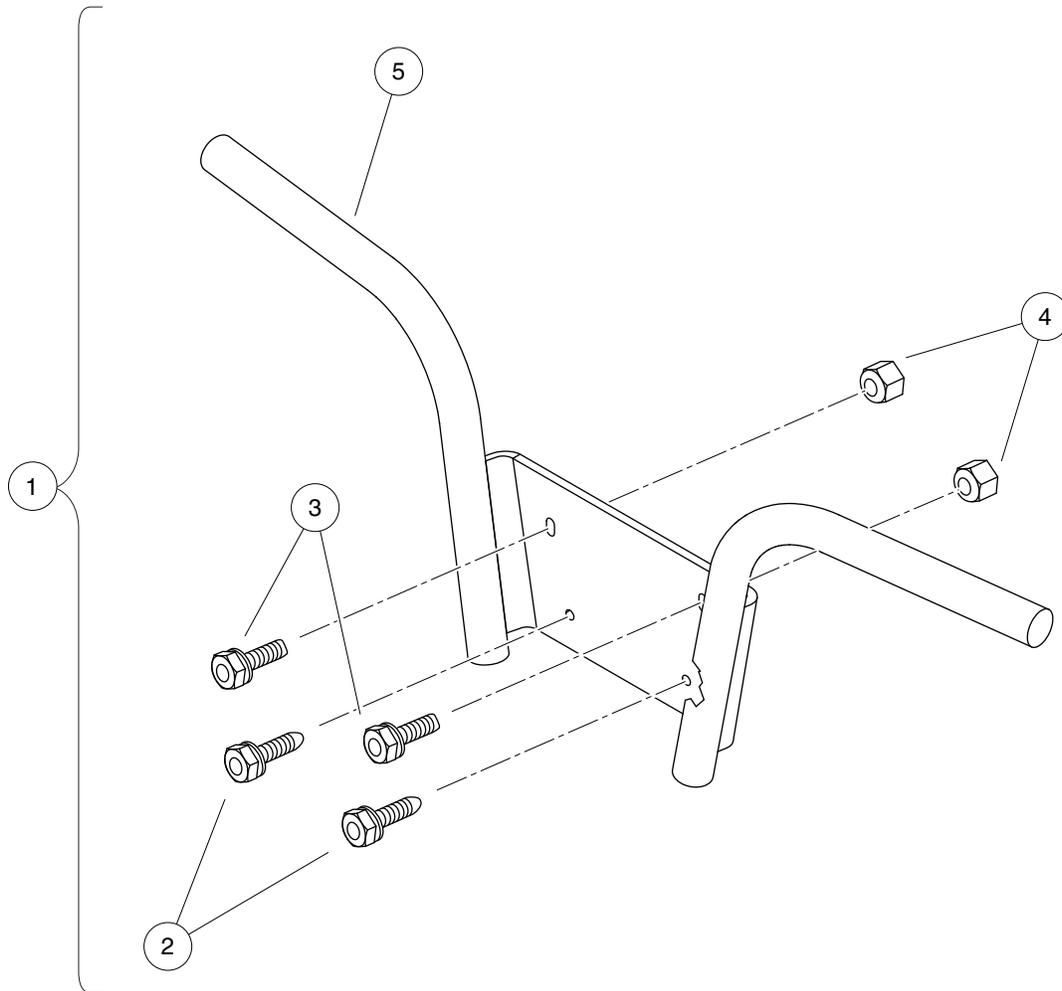

000356-001

BRUSH GUARD

ITEM	PART NO.	DESCRIPTION	QTY
		1 2 3 4	
1	<u>102852401</u>	Kit, Brush Guard (includes items 2 through 5)	1
2	<u>102289002</u>	Screw, M8 X 1.25 X 30 Tri, Blk	2
3	<u>102298240</u>	Bolt, Flange Head, M8-1.25 X 40	2
4	102618601	Lock Nut, Flange, M8 X 1.25 Nylon	2
5	102830201	Guard, Brush	1

1
G
E

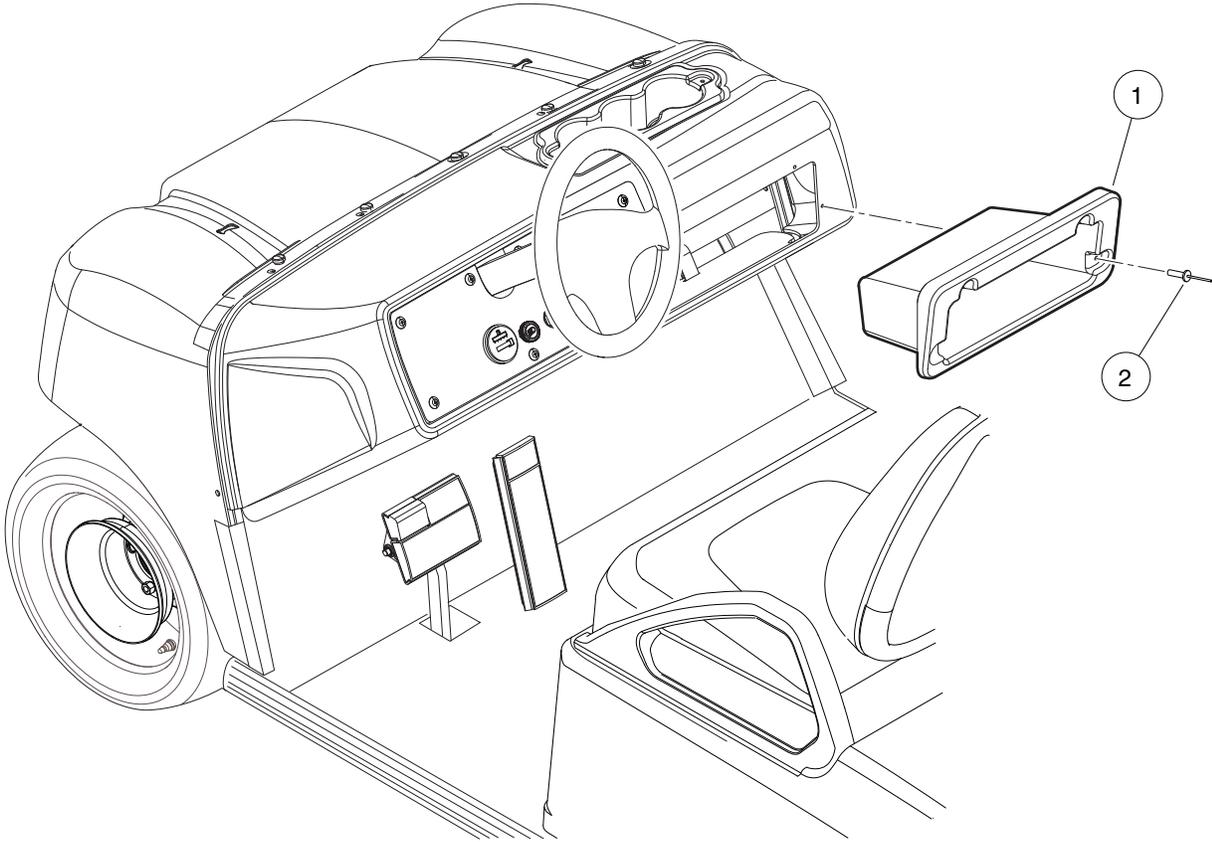

000358-001

DASH BOX

ITEM	PART NO.	DESCRIPTION	QTY
1	<u>102810301</u>	1 2 3 4 Box, Dash	1
2	<u>103344501</u>	Rivet, 5/32" Dia., Black	4

1
G
E

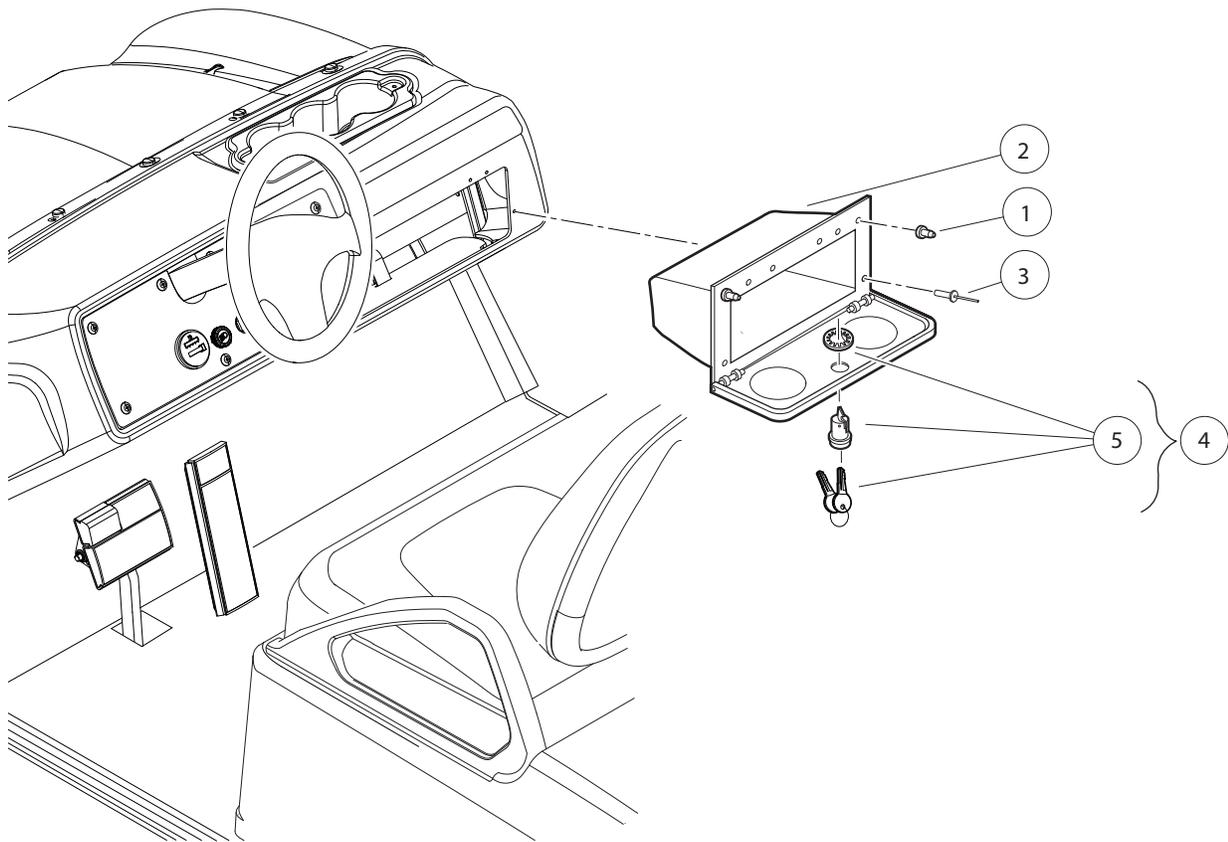

000359-002

GLOVE BOX

ITEM	PART NO.	DESCRIPTION	QTY
		1 2 3 4	
1	<u>1010436</u>	Bumper, Rubber	2
2	<u>102796501</u>	Glove Box	1
3	<u>102828701</u>	Rivet	6
4	<u>102959401</u>	Glove Box Lock / Key Kit (includes item 5)	1
5	N/A	Asm, Glove Box Lock / Key	1

1
G
E

1
G
E

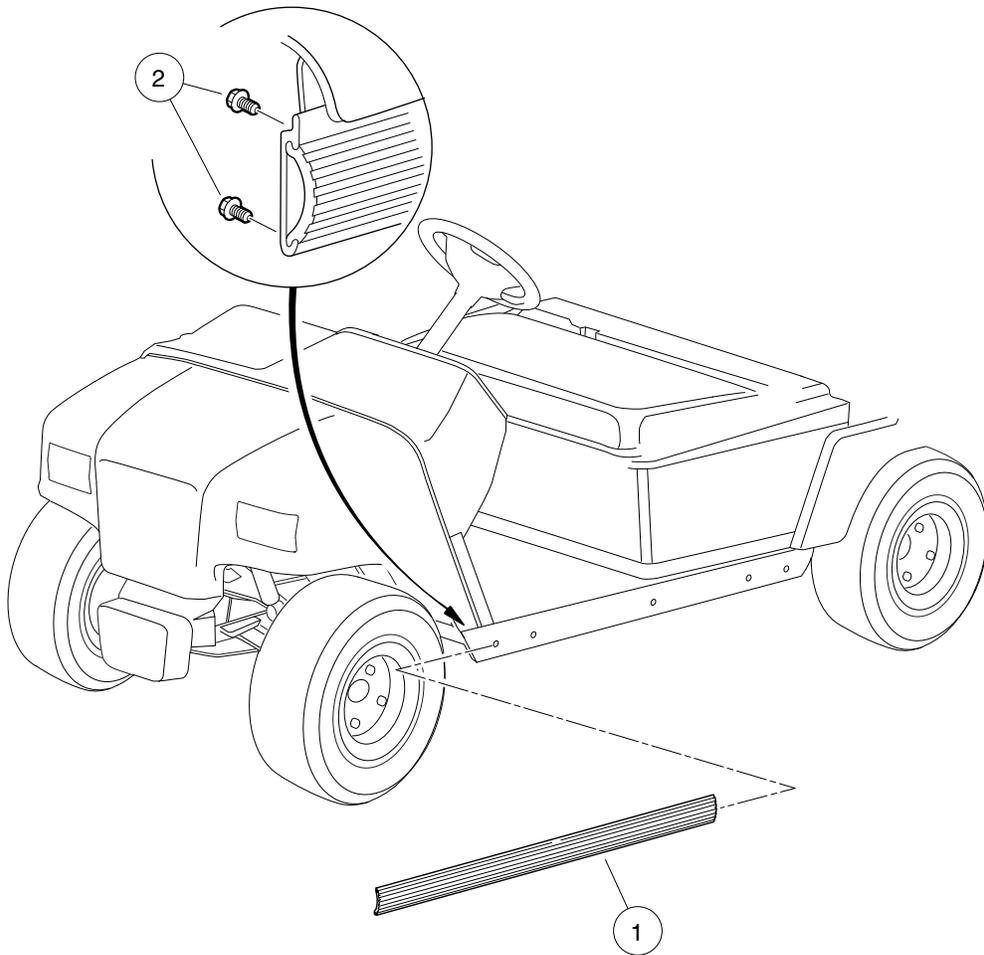

000361-002

SIDE TRIM

ITEM	PART NO.	DESCRIPTION	QTY
1	<u>1013983</u>	1 2 3 4 Bumper, Side Trim	2
2	<u>102310701</u>	Screw, #8-18 x 0.375, Hex-Head Washer	8

1
G
E

1
G
E

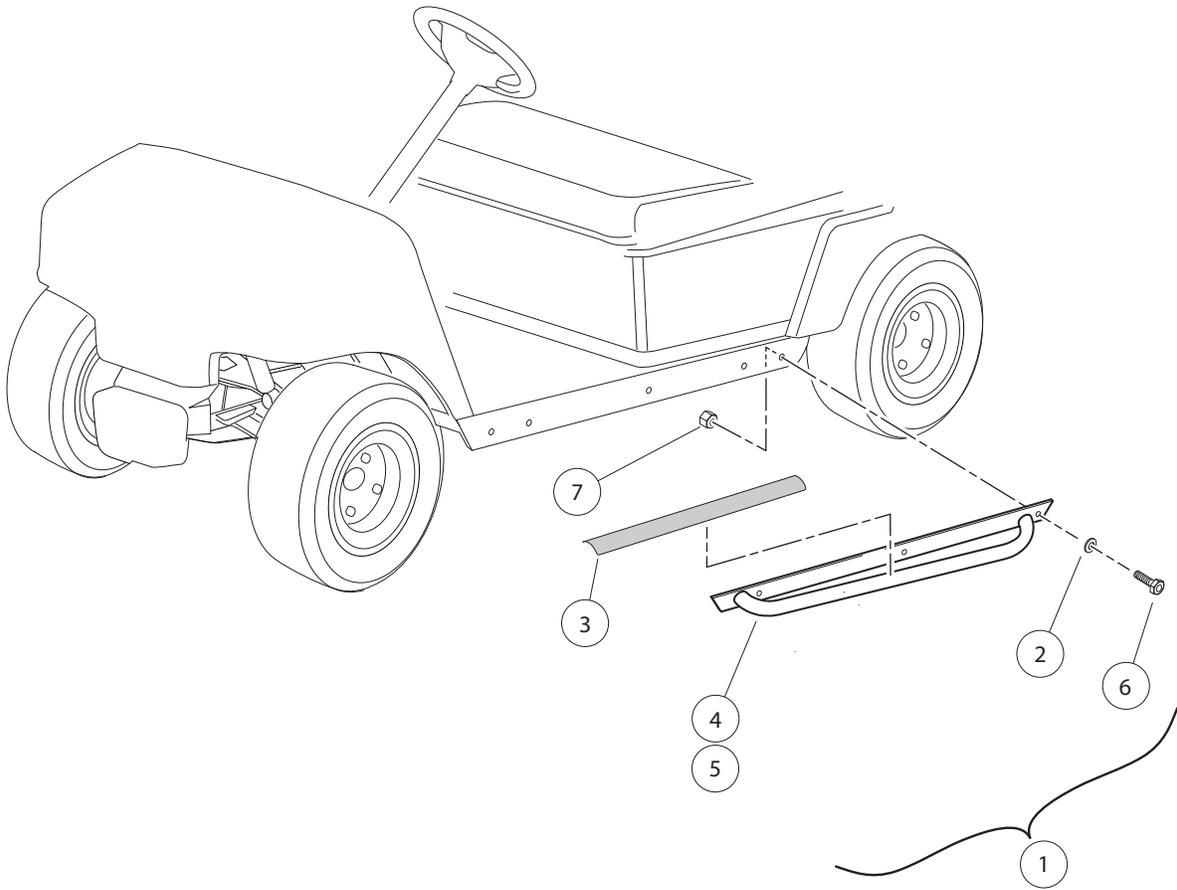

000360-004

NERF BAR

ITEM	PART NO.	DESCRIPTION	QTY
		1 2 3 4	
1	<u>102829802</u>	Kit, Nerf Bar (black) (includes items 2 through 7)	1
2	<u>1011990</u>	Washer, 3/8 Flat	6
3	<u>102355102</u>	Tape, Non-skid	2
4	<u>102829703</u>	Nerf Bar Assy, Driver	1
5	<u>102829704</u>	Nerf Bar Assy, Passenger	1
6	<u>320</u>	Screw, 3/8-16 X 1.00 Hex-Head Cap	6
7	<u>8754</u>	Locknut, 3/8-16 Hex	6

1
G
E

REAR BODY AND FENDER – GASOLINE VEHICLE

ITEM	PART NO.	DESCRIPTION	QTY
		1 2 3 4	
1	<u>1010993</u>	Body Kick Plate	1
2	<u>1012412</u>	Body, Hinge Plate	2
3	<u>1014306</u>	Washer, 1/4" Type B Flat	8
4	<u>1017141</u>	Body Support Weldment	1
5	<u>101855801</u>	Cable Retainer	1
6	<u>102221201</u>	Wear Pad	2
7	<u>102777601</u>	Fender, Driver Side (includes item 8)	1
8	<u>1016952</u>	U-Nut, 1/4-20	4
9	<u>102777602</u>	Fender, Passenger Side (includes item 10)	1
10	<u>1016952</u>	U-Nut, 1/4-20	4
11	<u>102796801</u>	Body, Rear, Gas, Red	1
12	<u>102796802</u>	Body, Rear, Gas, Orange	1
13	<u>102796803</u>	Body, Rear, Gas, Green	1
14	<u>102796804</u>	Body, Rear, Gas, Classic Blue	1
15	<u>102796805</u>	Body, Rear, Gas, Olive Green	1
16	<u>332</u>	Washer, 1/4 Type A Narrow Flat	6
17	<u>7847</u>	Screw, 1/4-20 X 0.75 Hex-Head Cap	8
18	<u>8233</u>	Locknut, 1/4-20, Nylon Insert	6
19	<u>8251</u>	Screw, 1/4-20 X 1.0 Truss-Head Machine	6

1
G
E

1
G
E

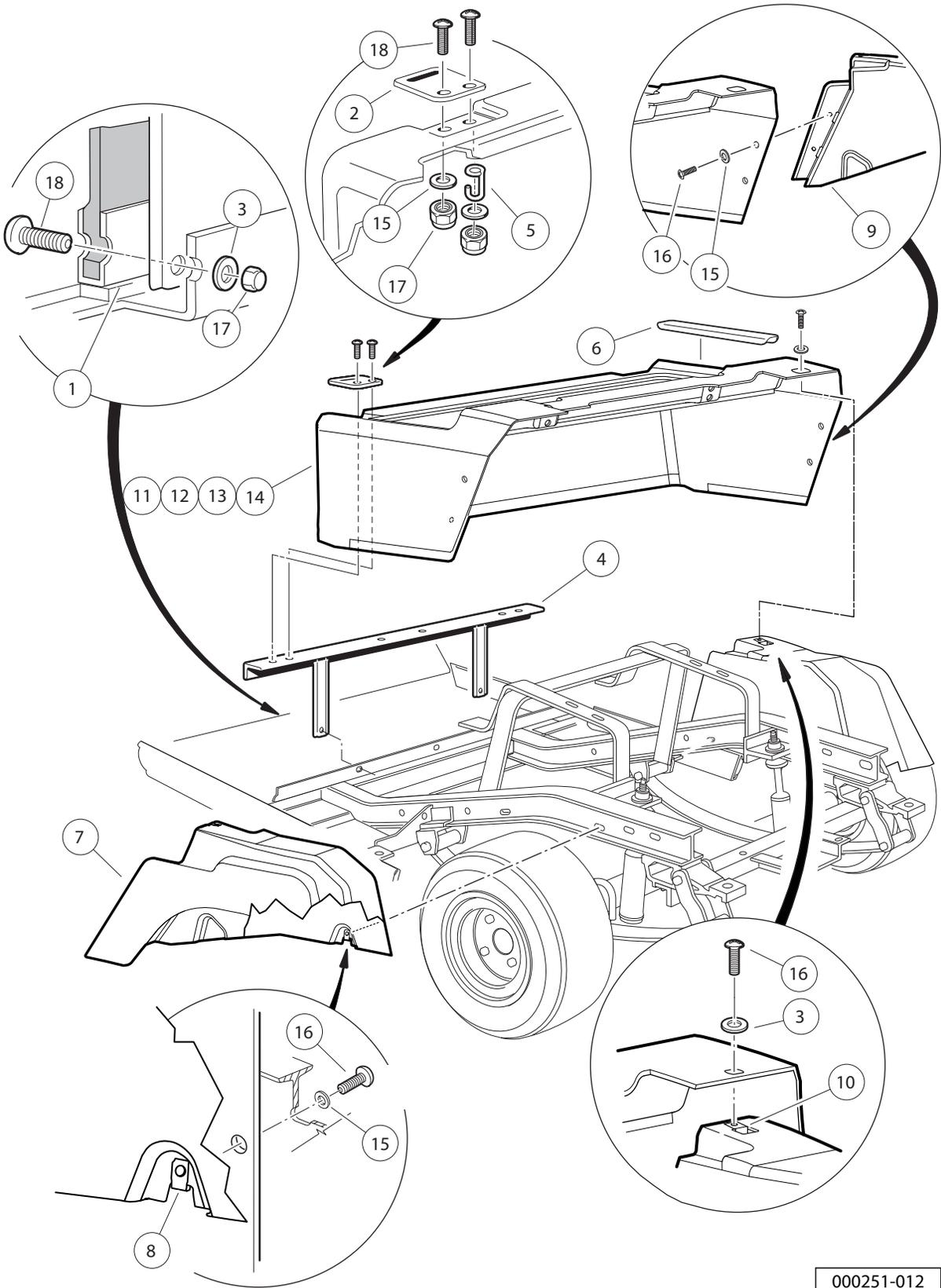

000251-012

REAR BODY AND FENDER – ELECTRIC VEHICLE

ITEM	PART NO.	DESCRIPTION	QTY
		1 2 3 4	
1	<u>1010993</u>	Body Kick Plate	1
2	<u>1012412</u>	Body, Hinge Plate	2
3	<u>1014306</u>	Washer, 1/4" Type B Flat	8
4	<u>1017141</u>	Body Support Weldment	1
5	<u>101855801</u>	Cable Retainer	1
6	<u>102221201</u>	Wear Pad	2
7	<u>102777601</u>	Fender, Driver Side (includes item 8)	1
8	<u>1016952</u>	U-Nut, 1/4-20	4
9	<u>102777602</u>	Fender, Passenger Side (includes item 10)	1
10	<u>1016952</u>	U-Nut, 1/4-20	4
11	<u>102818301</u>	Body, Rear, Electric, Red	1
12	<u>102818302</u>	Body, Rear, Electric, Orange	1
13	<u>102818303</u>	Body, Rear, Electric, Green	1
14	<u>102818305</u>	Body, Rear, Electric, Olive Green	1
15	<u>332</u>	Washer, 1/4 Type A Narrow Flat	6
16	<u>7847</u>	Screw, 1/4-20 X 0.75 Hex-Head Cap	8
17	<u>8233</u>	Locknut, 1/4-20, Nylon Insert	6
18	<u>8251</u>	Screw, 1/4-20 X 1.0 Truss-Head Machine	6

1
G
E

1
G
E

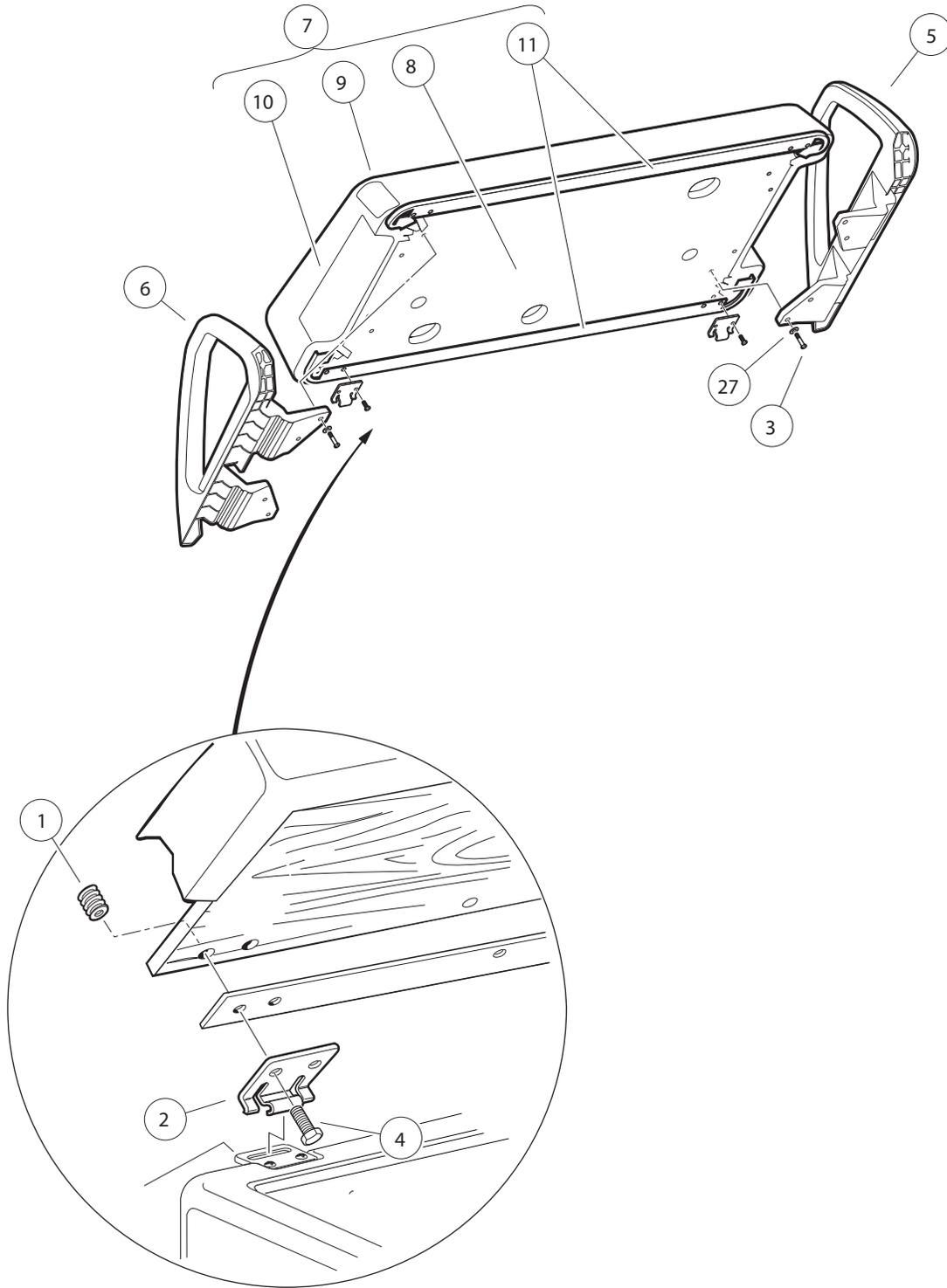

000364-003

FRONT SEAT BOTTOM AND ARMRESTS

ITEM	PART NO.	DESCRIPTION	QTY
		1 2 3 4	
1	1010543	Insert - Wood	4
2	<u>1011652</u>	Hinge Plate	2
3	1016916	Screw, 1/4-20 X 1.50 Hex-Head Cap	8
4	<u>101954301</u>	Screw, 1/4-20 X 0.75 Hex-Head Cap	4
5	101985502	Armrest, Passenger (right)	1
6	<u>101987602</u>	Armrest, Driver (left)	1
7	<u>102174201</u>	Seat Bottom Assembly, Buff (includes items 8 through 11)	1
8	N/A	Plywood Assy	1
9	<u>101998211</u>	Vinyl Cover Seat Btm - Buffsvc	1
10	N/A	Foam, Seat	1
11	<u>101998501</u>	Gasket, Seat	2
12	<u>102174202</u>	Seat Bottom Assembly, White (includes items 13 through 16)	1
13	N/A	Plywood Assy	1
14	<u>101998212</u>	Vinyl Cover, Seat Bottom, White	1
15	N/A	Foam, Seat	1
16	<u>101998501</u>	Gasket, Seat	2
17	<u>102174204</u>	Seat Bottom Assembly, Black (includes items 18 through 21)	1
18	N/A	Plywood Assy	1
19	<u>101998214</u>	Vinyl Cover, Seat Bottom, Black	1
20	N/A	Foam, Seat	1
21	<u>101998501</u>	Gasket, Seat	2
22	<u>102174205</u>	Seat Bottom Assembly, Gray (includes items 23 through 26)	1
23	N/A	Plywood Assy	1
24	<u>101998215</u>	Vinyl Cover, Seat Bottom, Gray	1
25	N/A	Foam, Seat	1
26	<u>101998501</u>	Gasket, Seat	2
27	<u>332</u>	Washer, 1/4 Type A Narrow Flat	8
Note: Sub-components contained in items 12, 17, and 22 are the same as those shown for item 7, except for the vinyl seat covers.			

1
G
E

SEAT BACK

ITEM	PART NO.	DESCRIPTION	QTY
		1 2 3 4	
1	<u>1011931</u>	Washer, 1/4 Flat	12
2	<u>1017774</u>	Body Spacer	4
3	<u>101910401</u>	Screw, 5/16-18 X 1.25 Thrd Frm	4
4	<u>102296530</u>	Screw - M6 X 1.0 X 30 Sems	2
5	<u>102503221</u>	Service Backrest Asm, Beige	1
6	<u>102503222</u>	Service Backrest Asm, White	1
7	<u>102503224</u>	Service Backrest Asm, Gray	1
8	<u>102544201</u>	Screw, M6 Hex	2
9	<u>102581201</u>	Plug, Square - 25.4 mm	2
10	<u>102796101</u>	Weldment, Bed Support	1
11	<u>102816201</u>	Seat Support, Cross Brace	1
12	<u>102913101</u>	Seat Support W/striker, Drv (includes items 13 through 16)	1
13	<u>102796301</u>	Seat Support, Driver-Side	1
14	<u>102840301</u>	Striker Plate	1
15	<u>7847</u>	Screw, 1/4-20 X 0.75 Hex-Head Cap	2
16	<u>8233</u>	Locknut, 1/4-20, Nylon Insert	2
17	<u>102913102</u>	Support, Seat, Right (passenger) (includes items 18 through 21)	1
18	<u>102796302</u>	Seat Support, Passenger-Side	1
19	<u>102840301</u>	Striker Plate	1
20	<u>7847</u>	Screw, 1/4-20 X 0.75 Hex-Head Cap	2
21	<u>8233</u>	Locknut, 1/4-20, Nylon Insert	2
22	<u>1241</u>	Washer, 5/16 Type A Flat	4
23	<u>7311</u>	Screw, 1/4-20 X 2.00 Hex-Head Cap	6
24	<u>8233</u>	Locknut, 1/4-20, Nylon Insert	6

1
G
E

1
G
E

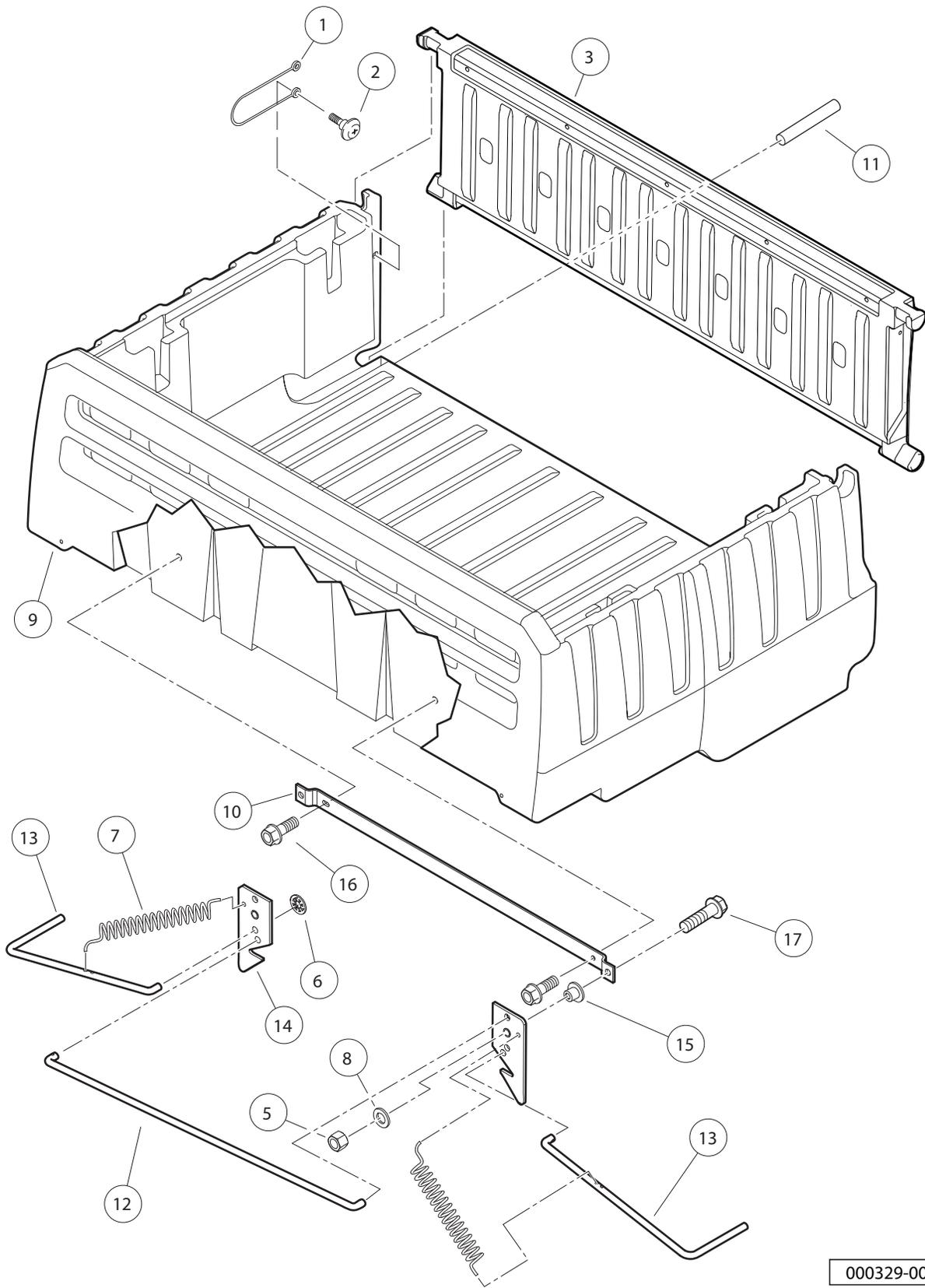

000329-002

CARGO BED

ITEM	PART NO.	DESCRIPTION	QTY
		1 2 3 4	
1	<u>102779001</u>	Lanyard, Tailgate	2
2	<u>102779401</u>	Bolt Lanyard	2
3	102779501	Tailgate	1
4	<u>103189901</u>	Bed Assembly (includes items 5 through 17)	1
5	<u>1010138</u>	Locknut, 3/8-16 Dimpled	2
6	<u>1013876</u>	Pushnut, 3/8	4
7	<u>1015391</u>	Extension, Spring Latch	2
8	N/A	Washer, 3/8 Flat Type A	2
9	N/A	Bed	1
10	<u>102778901</u>	Support, Latch Link	1
11	N/A	Pin, Support	2
12	<u>102779201</u>	Rod, Long Link	1
13	<u>102779301</u>	Rod, Bed Lift, Short Bent	2
14	<u>102779601</u>	Catch, Tilt Bed	2
15	<u>102830701</u>	Bearing, Bronze, 1/2x9/32	2
16	304	Screw, 1/4-20 X 1.0 Hex-Head Cap	2
17	320	Screw, 3/8-16 X 1.00 Hex-Head Cap	1
18	<u>103317501</u>	Kit, Plastic Bed Box Latch (includes items 19 through 21)	1
19	<u>1010545</u>	Screw, Hex Washer Head 1/4-14 X .75	2
20	<u>1011578</u>	Washer, 5/16 Type B Flat	2
21	103293501	Spring, Tilt Latch 3.4 Lb/in	2

1
G
E

1
G
E

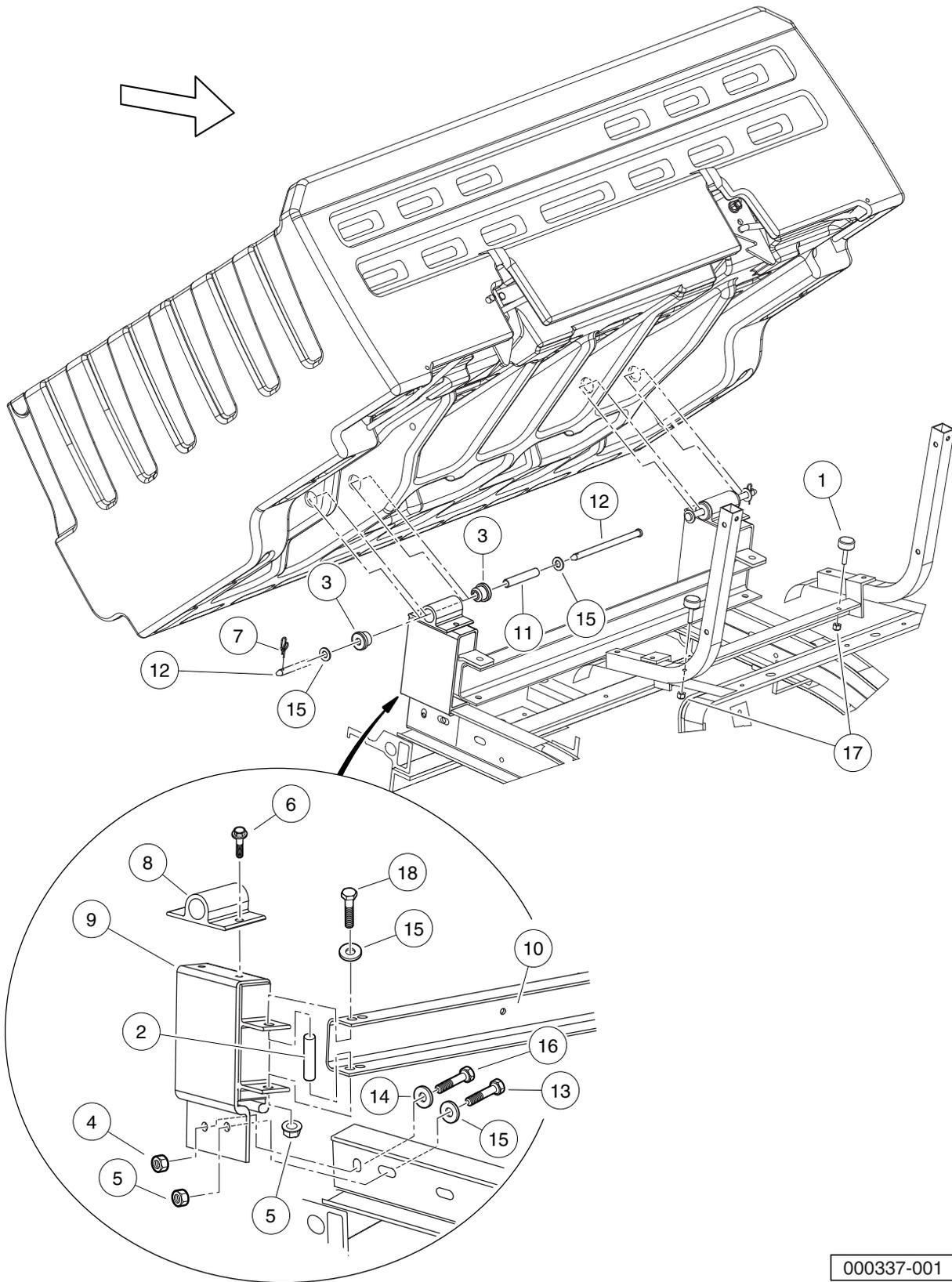

000337-001

BED HINGE

ITEM	PART NO.	DESCRIPTION	QTY
		1 2 3 4	
1	<u>1010878</u>	Bumper, Rubber	2
2	<u>1012303</u>	Bushing, Steel	2
3	<u>1015583</u>	Bushing, Urethane	4
4	<u>101835601</u>	Locknut, 1/4-20 Hex Whiz	2
5	<u>102065901</u>	Locknut, 3/8-16 Flanged Dimple	4
6	<u>102289001</u>	Screw, M8X1.25X30, Hex	4
7	<u>102289301</u>	Rue Ring - 1/2"	2
8	<u>102797201</u>	Hinge, Roto Bed	2
9	<u>102820301</u>	Support, Hinge	2
10	<u>102820501</u>	Stiffener, Bed Support	1
11	<u>102821101</u>	Bushing, Steel	2
12	<u>102823201</u>	Pin, Clevis, 3/8	2
13	<u>320</u>	Screw, 3/8-16 X 1.00 Hex-Head Cap	2
14	<u>332</u>	Washer, 1/4 Type A Narrow Flat	2
15	<u>334</u>	Washer, 3/8, Type A, Flat	8
16	<u>7847</u>	Screw, 1/4-20 X 0.75 Hex-Head Cap	2
17	<u>8233</u>	Locknut, 1/4-20, Nylon Insert	2
18	<u>8755</u>	Screw, 3/8-16 X 3.375 Hex Cap	2

1
G
E

1

G

E

WHEELS AND TIRES

2

G

E

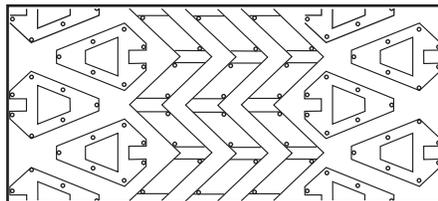
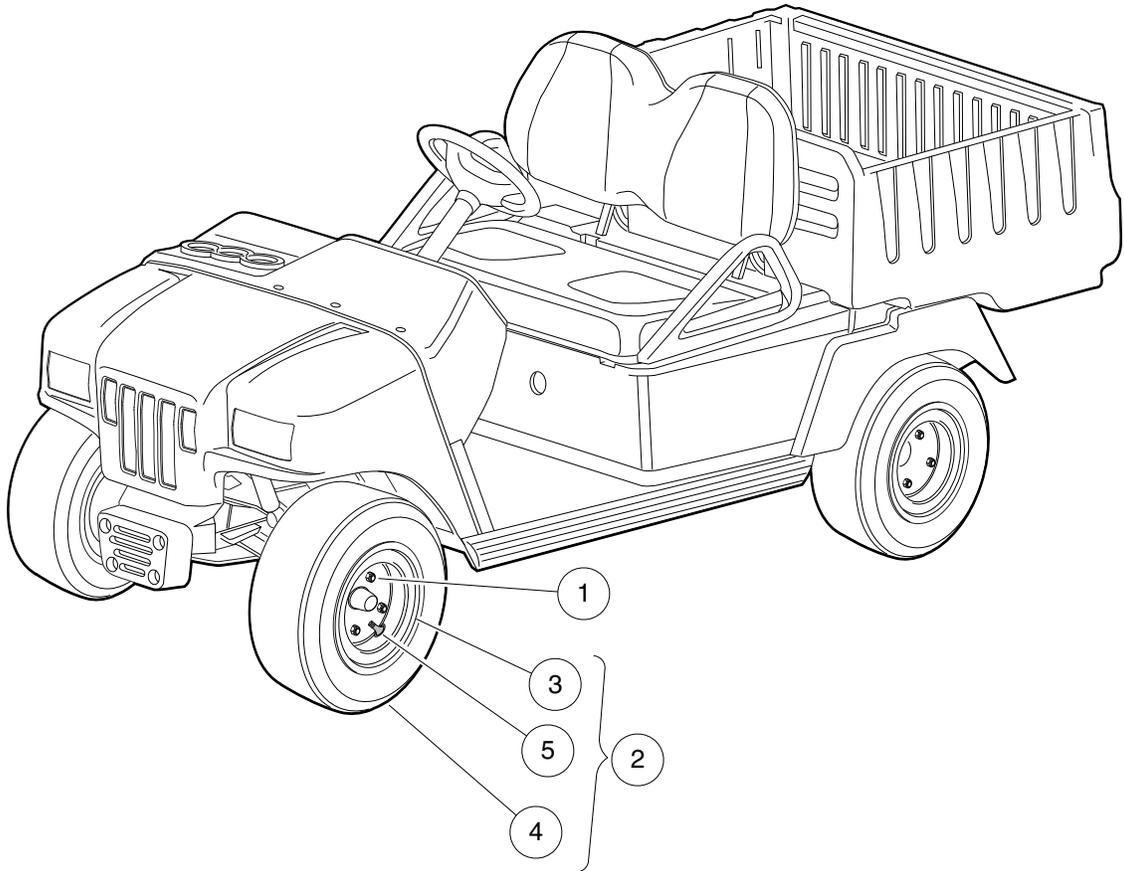

000224-002

WHEELS AND TIRES

ITEM	PART NO.	DESCRIPTION	QTY
		1 2 3 4	
1	<u>1010984</u>	.500-20 Unf Lug Nut	16
2	<u>102819101</u>	Tire Assembly, All Trail II (includes items 3 through 5)	4
3	<u>102815801</u>	Wheel Rim, Gray	1
4	<u>102815901</u>	Tire, Unmounted, All Trail II	1
5	<u>7310</u>	Valve Stem, Black Plastic	1

2
G
E

2

G

E

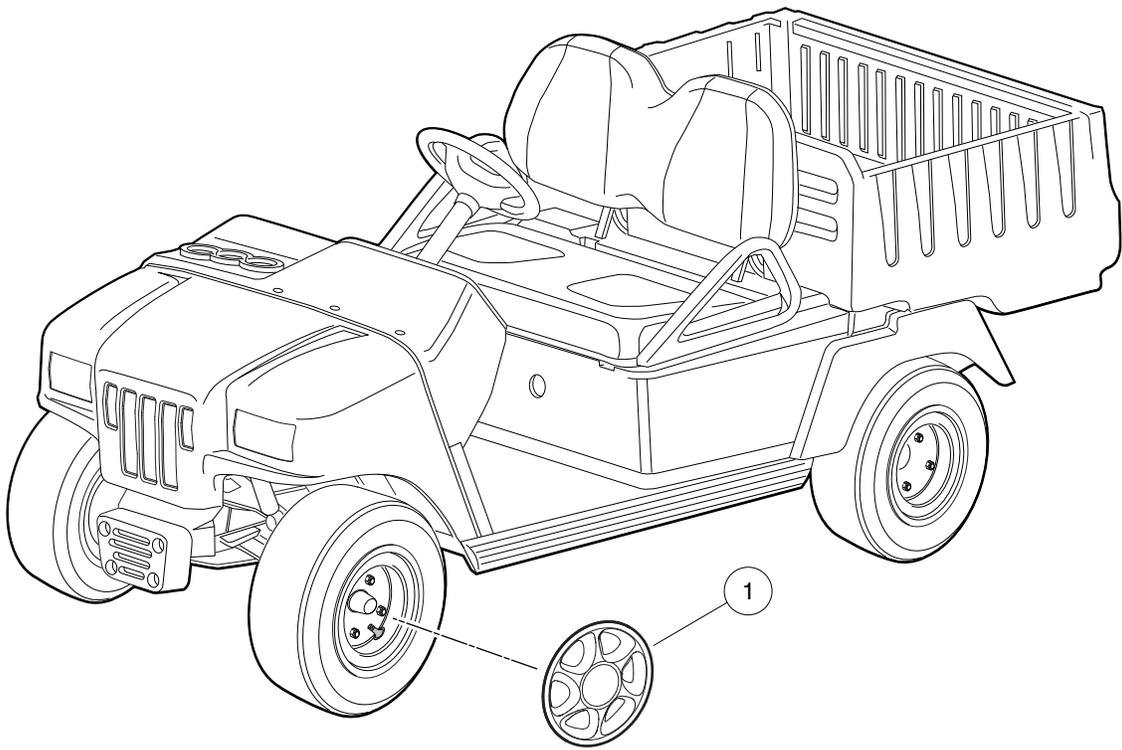

000318-002

HUBCAP

ITEM	PART NO.	DESCRIPTION	QTY
1	<u>102861401</u>	1 2 3 4 Wheel Cover, Chrome Elite	4

2
G
E

2

G

E

DECALS

3

G

E

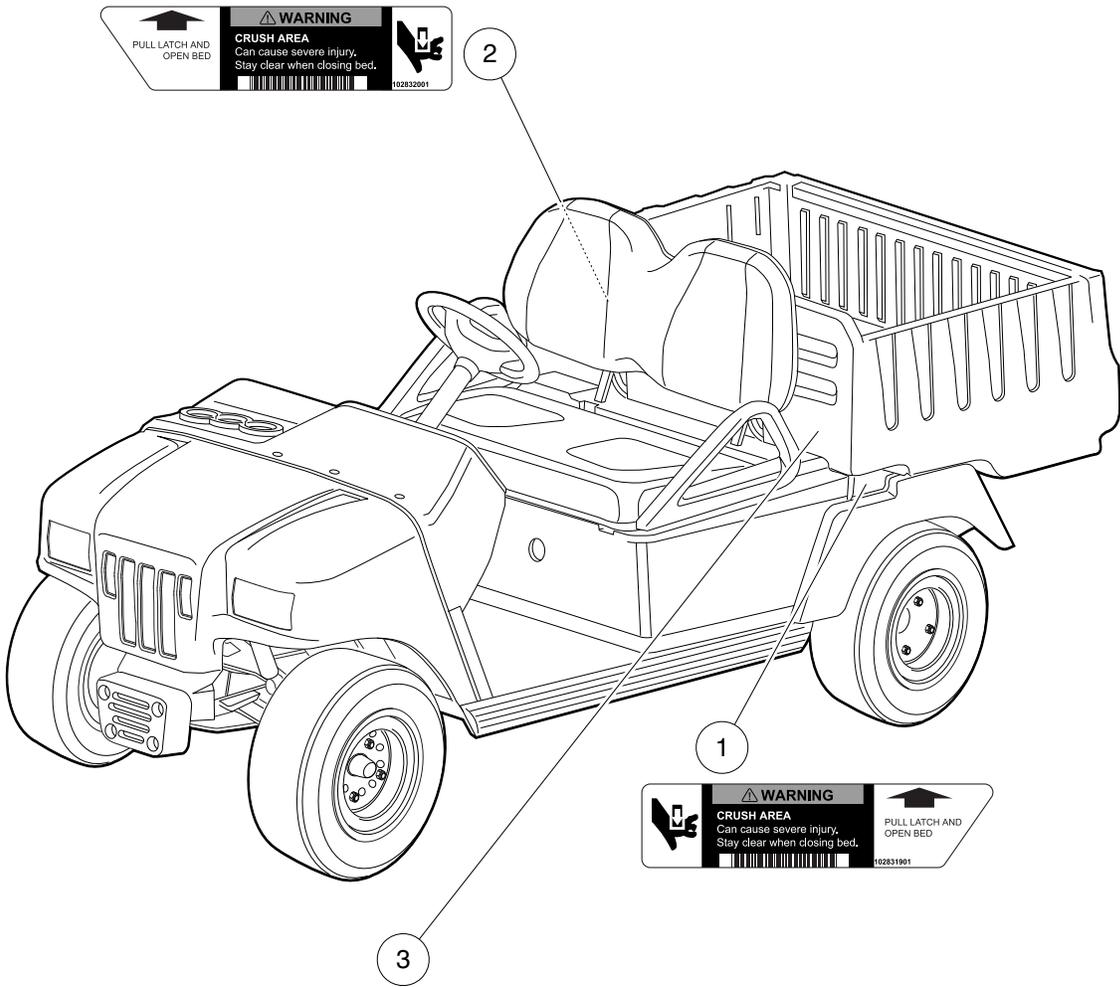

PULL LATCH AND OPEN BED.

WARNING

CRUSH AREA
Can cause severe injury.
Stay clear when closing bed.

102832001

WARNING

CRUSH AREA
Can cause severe injury.
Stay clear when closing bed.

102831901

PULL LATCH AND OPEN BED.

NOTICE

• THE OWNER/OPERATOR should maintain, lubricate, adjust, and operate the vehicle as detailed in the vehicle owners manual.

CC1 102832001

000225-002

SAFETY DECALS – GASOLINE VEHICLES

ITEM	PART NO.	DESCRIPTION	QTY
		1 2 3 4	
1	<u>102831901</u>	Decal, Crush Warning, Driver-Side	1
2	<u>102832001</u>	Decal, Crush Warning, Passenger-Side	1
3	<u>102833301</u>	Decal, Maintenance	1

3
G
E

WARNING

- GASOLINE EXPLOSION / FIRE.
- CAN CAUSE SEVERE INJURY OR DEATH.
- NO SMOKING, SPARKS, OR OPEN FLAME.
- STOP ENGINE, ALLOW TO COOL BEFORE REFUELING.
- TURN FUEL VALVE () ON DURING OPERATION.
- () OFF DURING STORAGE OR TRANSPORT.

CC1 1015476-01

WARNING

CAN CAUSE SEVERE INJURY

Rotating parts

HOT manifold & muffler

KEEP CLEAR

CC1 101960501

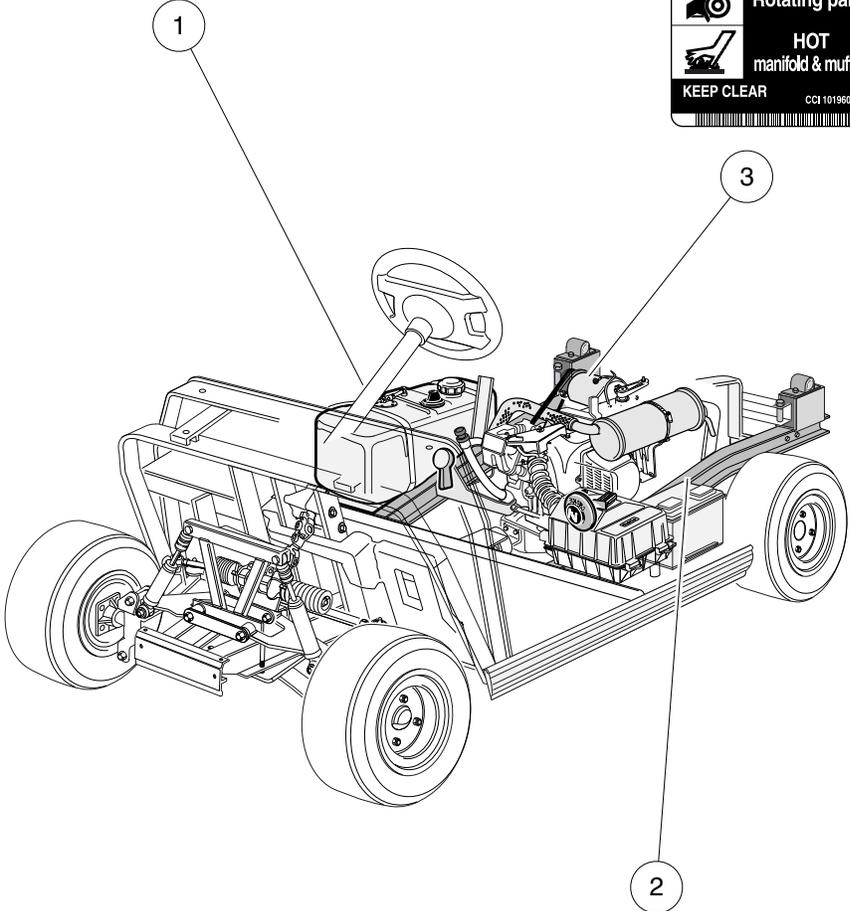

	<p>WARNING</p> <p>Negative frame ground. Can cause severe injury. Do not contact positive (+) battery post or cable to frame. Disconnect negative battery lead first.</p>		<p>WARNING</p> <p>Excessive speed. Can cause severe injury or death. Do not tamper with engine governor adjustment.</p> <p><small>CC1 1019152-01</small></p>
--	--	--	---

000226-001

SAFETY DECALS – GASOLINE VEHICLES, CONTINUED

ITEM	PART NO.	DESCRIPTION	QTY
		1 2 3 4	
1	<u>101547601</u>	Decal, Gasoline Explosion/Fire Warning	1
2	<u>101915201</u>	Decal, Frame Ground and Governor Warning	1
3	<u>101960501</u>	Decal, Rotating Parts/Hot Manifold	1

3
G
E

OPERATING INSTRUCTIONS

- Read owner's manual and dash-mounted safety warnings prior to driving.
- Study and understand controls.

TO START ENGINE

- Place shift lever in "N" – Neutral position.
- Press brake pedal.
- Turn key switch to "START" position and release.

TO OPERATE VEHICLE

- Turn wheels to desired direction and ensure path is clear.
- Engine must be at idle before moving shift lever.
- While vehicle is stopped, and engine is at idle, place Forward/Reverse switch in desired position:
F – Forward N – Neutral R – Reverse (Buzzer will sound)
- Park brake will release and vehicle will start moving when accelerator pedal is pressed.
- Slowly press accelerator pedal to increase speed.
- To stop, release accelerator pedal and push brake pedal.

BEFORE LEAVING

- Press park brake pedal until it locks and holds vehicle.
- Place Forward/Reverse switch in NEUTRAL position.
- Turn key to "OFF" position and remove key when not in use.

102825601

WARNING

ROLLOVER OR FALLING OFF MAY CAUSE SERIOUS INJURY OR DEATH

- Before using vehicle, read operating instructions.
- Do not start vehicle until all occupants are seated.
- Operate from driver side only and not on public roads.
- Drive slowly in turns and straight up and down slopes.
- Never operate under the influence of alcohol or drugs.
- Use brakes to reduce speed when coasting downhill.
- Remain seated while moving.
- Hold on to seat handle while moving.
- Two (2) persons per seat maximum.
- Never stand in front of or behind vehicle.
- Do not leave children unattended on vehicle.
- Keep entire body inside vehicle while moving.

OFF ON START

102825401

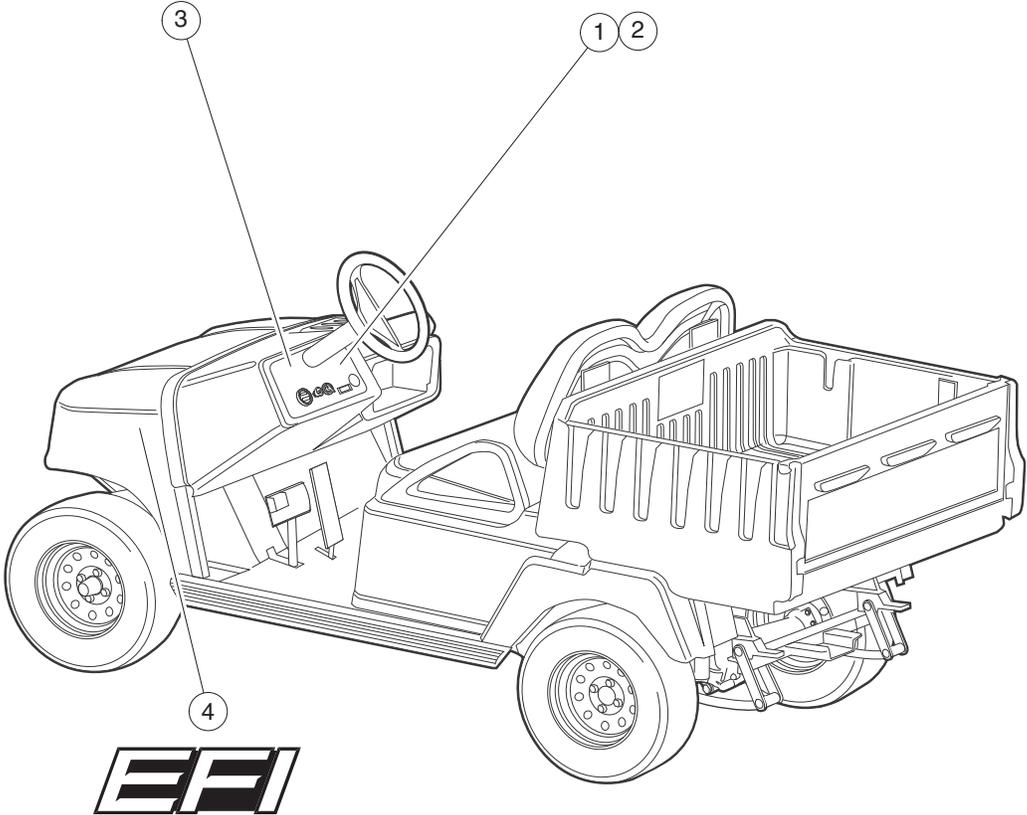

SAFETY DECALS – GASOLINE VEHICLES, CONTINUED

ITEM	PART NO.	DESCRIPTION	QTY
		1 2 3 4	
1	<u>102825401</u>	Decal, Warning, Instrument Panel	1
2	<u>102825402</u>	Decal, Warning, Instrument Panel	1
3	<u>102825601</u>	Decal, Operating Instructions, Instrument Panel	1
<p>Note: Item 2 is for use on vehicles equipped with a 12-volt accessory outlet.</p>			

3
G
E

3
G
E

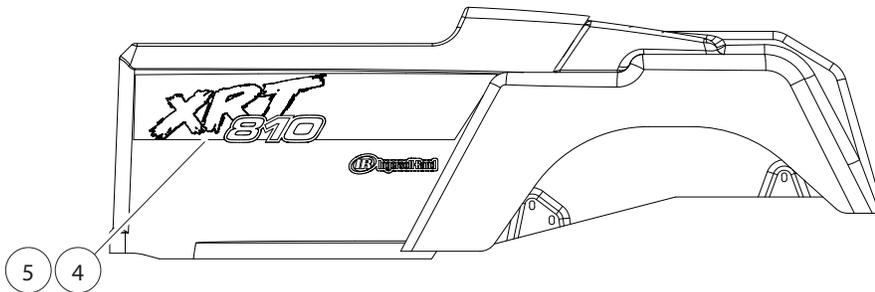
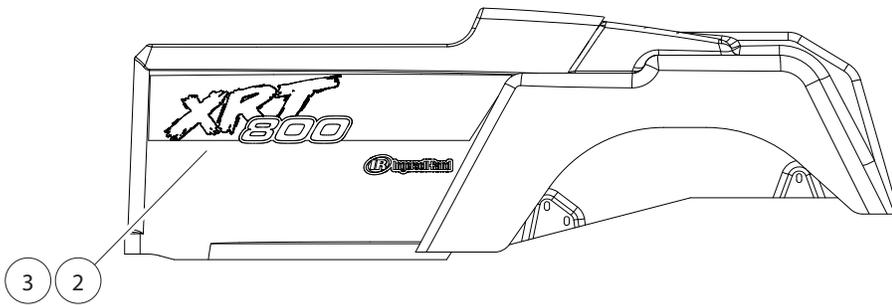
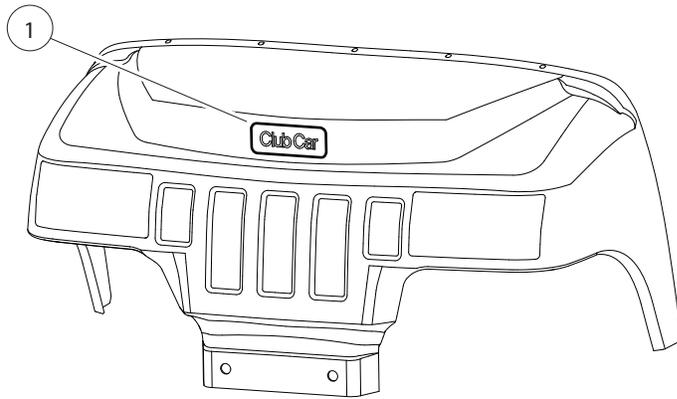

000300-005

LOGO DECALS – GASOLINE VEHICLES

ITEM	PART NO.	DESCRIPTION	QTY
		1 2 3 4	
1	<u>102278801</u>	Decal, Club Car	1
2	<u>102850801</u>	Decal, 800 Drv	1
3	<u>102850901</u>	Decal, 800 Pass	1
4	<u>102851201</u>	Decal, 810 Drv	1
5	<u>102851301</u>	Decal, 810 Pass	1

3
G
E

NOTICE
Do not operate vehicle without this cover properly installed.
Do not direct water stream in this area; will cause damage to components.
CCI 101931501

WARNING TOW RUN

Place Tow/Run switch in TOW position before:

- Disconnecting or connecting batteries
- Towing
- Extended storage
- Servicing

FAILURE TO HEED THIS WARNING COULD RESULT IN A BATTERY EXPLOSION INJURY.
CCI 101908601

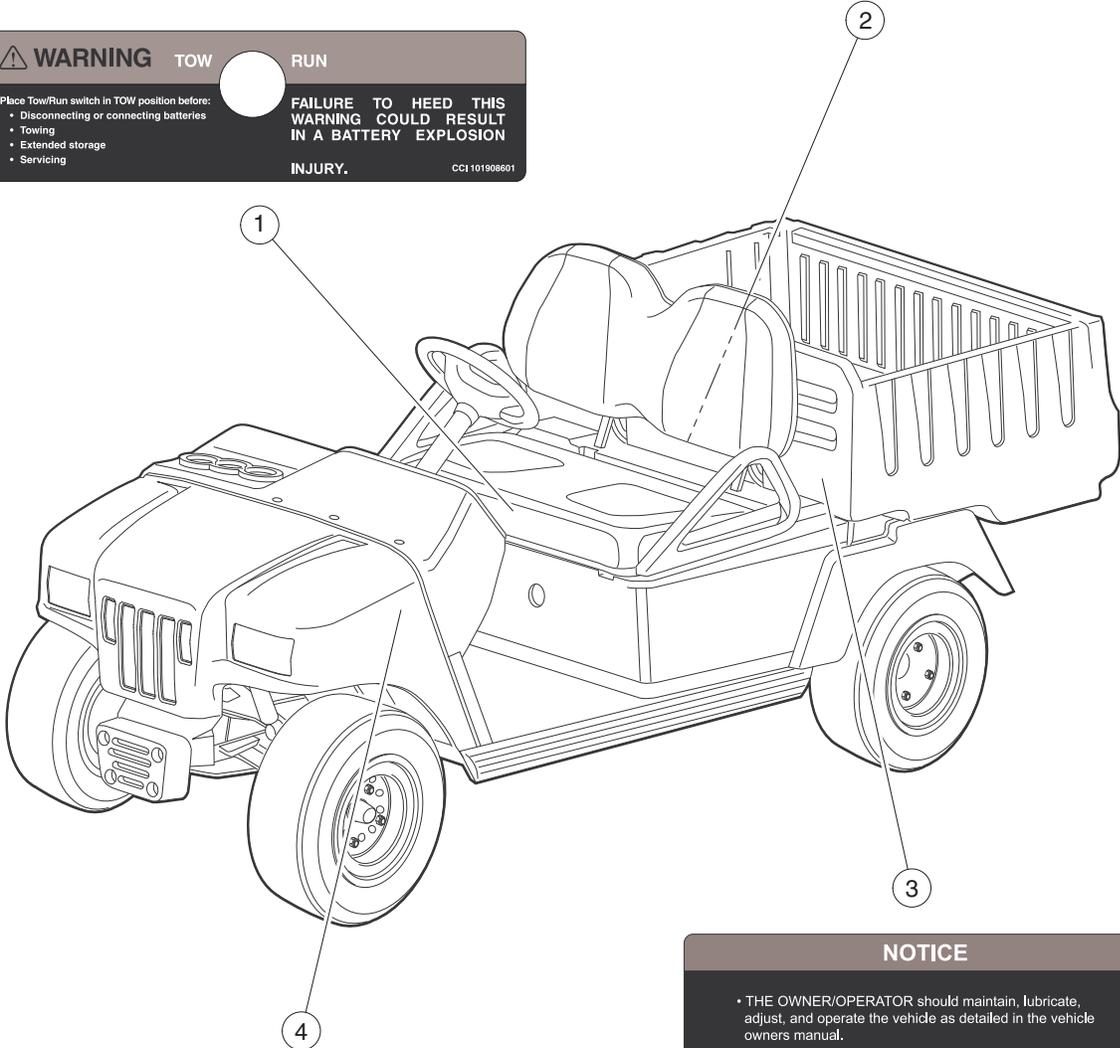

NOTICE

- THE OWNER/OPERATOR should maintain, lubricate, adjust, and operate the vehicle as detailed in the vehicle owners manual.

CCI 102833301



SAFETY DECALS – ELECTRIC VEHICLES

ITEM	PART NO.	DESCRIPTION	QTY
1	<u>101908601</u>	1 2 3 4 Decal, Tow/Run Switch Warning	1
2	<u>101931501</u>	Decal, Component Cover	1
3	<u>102833301</u>	Decal, Maintenance	1

3
G
E

3
G
E

OPERATING INSTRUCTIONS

- Read owner's manual and dash-mounted safety warnings prior to driving.
- Study and understand controls.

TO OPERATE

- Turn wheels to desired direction and ensure path is clear.
- Turn key to ON position.
- While stopped, place Forward/Reverse switch in desired position:
F=Forward N=Neutral R=Reverse (Buzzer will sound)
- Park brake will release and vehicle will start moving when accelerator pedal is pressed.
- Slowly press accelerator pedal to increase speed.
- To stop, release accelerator pedal and press brake pedal.

BEFORE LEAVING

- Press park brake pedal until it locks and holds vehicle.
- Place Forward/Reverse switch in NEUTRAL position.
- Turn key to "OFF" position and remove key when not in use.

MOTOR BRAKING

- Electric motor braking provides speed regulation functions.
- For parked vehicle, beeping alarm indicates vehicle roll away.
- In operation, beeping alarm indicates reduction in motor braking.
- Apply brakes to further reduce vehicle speed as required.
- System is activated only when tow switch is in the RUN position.
- When towing this vehicle, tow switch must be in the TOW position.

102825701

WARNING

ROLLOVER OR FALLING OFF MAY CAUSE SERIOUS INJURY OR DEATH

- Before using vehicle, read operating instructions.
- Do not start vehicle until all occupants are seated.
- Operate from driver side only and not on public roads.
- Drive slowly in turns and straight up and down slopes.
- Never operate under the influence of alcohol or drugs.
- Use brakes to reduce speed when coasting downhill.
- Remain seated while moving.
- Hold on to seat handle while moving.
- Two (2) persons per seat maximum.
- Never stand in front of or behind vehicle.
- Do not leave children unattended on vehicle.
- Keep entire body inside vehicle while moving.

OFF ON

102825501

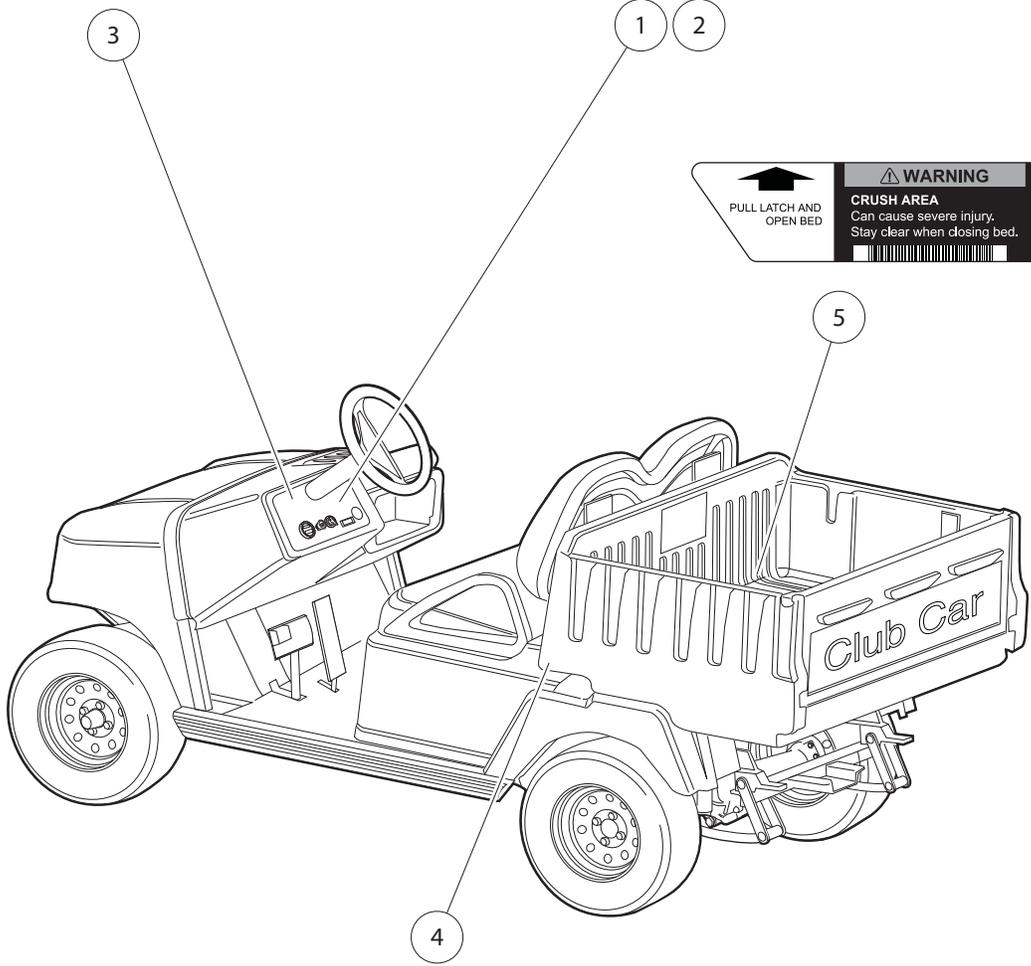

WARNING

PULL LATCH AND OPEN BED

CRUSH AREA
Can cause severe injury. Stay clear when closing bed.

102832001

WARNING

CRUSH AREA
Can cause severe injury. Stay clear when closing bed.

PULL LATCH AND OPEN BED

102831901

000229-003

SAFETY DECALS – ELECTRIC VEHICLES, CONTINUED

ITEM	PART NO.	DESCRIPTION	QTY
		1 2 3 4	
1	<u>102825501</u>	Decal, Warning, Instrument Panel	1
2	<u>102825502</u>	Decal, Warning, Instrument Panel	1
3	<u>102825701</u>	Decal, Operating Instructions, Instrument Panel	1
4	<u>102831901</u>	Decal, Crush Warning, Driver-Side	1
5	<u>102832001</u>	Decal, Crush Warning, Passenger-Side	1
<p>Note: Item 2 is for use on vehicles equipped with a 12-volt accessory outlet.</p>			

3
G
E

3
G
E

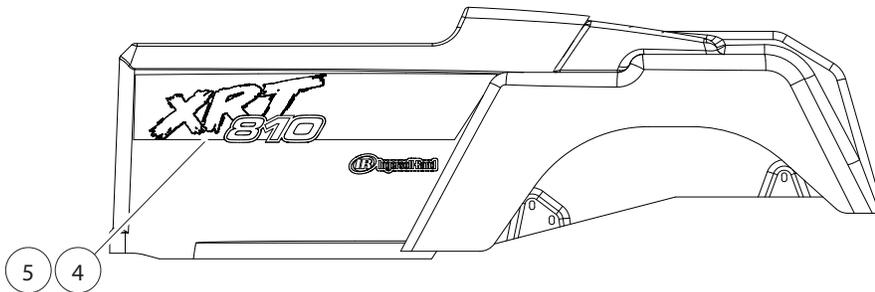
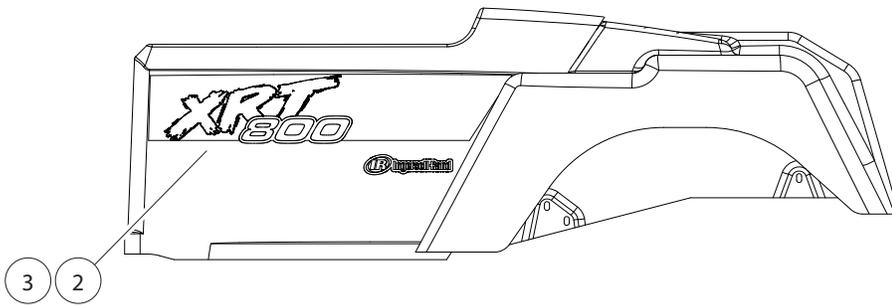
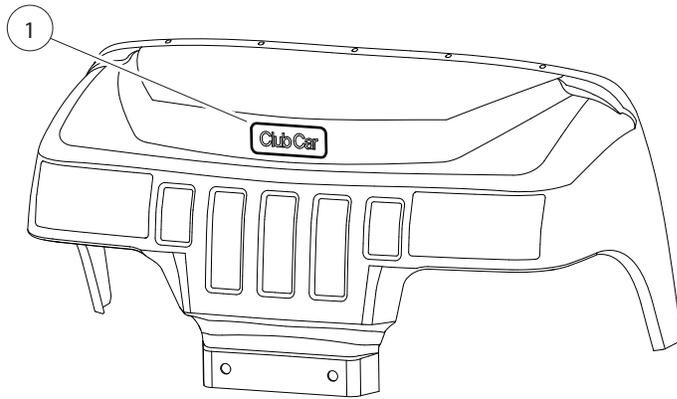

000300-005

LOGO DECALS

ITEM	PART NO.	DESCRIPTION	QTY
		1 2 3 4	
1	<u>102278801</u>	Decal, Club Car	1
2	<u>102851001</u>	Decal, 800E, Drv	1
3	<u>102851101</u>	Decal, 800E, Pass	1
4	<u>102851401</u>	Decal, 810E, Drv	1
5	<u>102851501</u>	Decal, 810E, Pass	1

3
G
E

3

G

E

LIGHTS, CONTROLS, AND INDICATORS

4

G

E

4
G
E

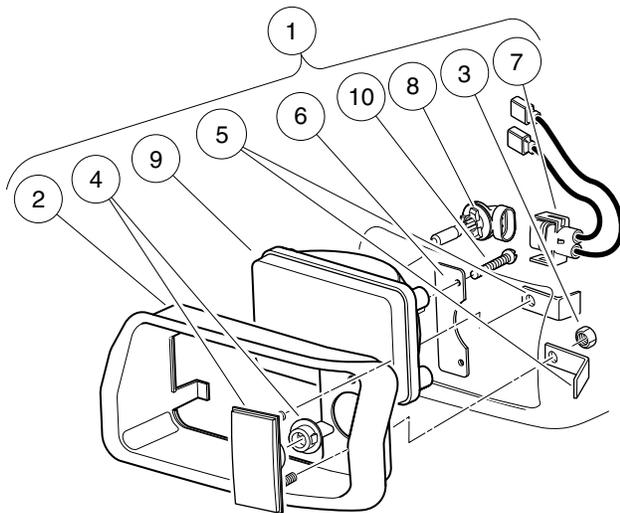
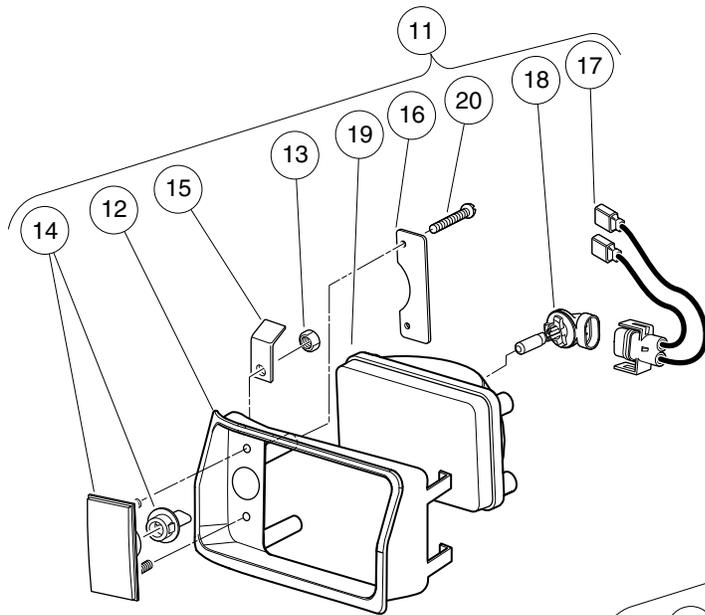

001097-001

HEADLIGHTS

ITEM	PART NO.	DESCRIPTION	QTY
		1 2 3 4	
1	<u>101988001</u>	Headlight Assembly, Driver-Side Single Beam (includes items 2 through 10)	1
2	<u>1016880</u>	Headlight Bezel, Left	1
3	<u>1017</u>	Nut, #10-24 Stainless-Steel Hex Machine	2
4	<u>1017062</u>	Turn Signal Lens Assy	1
5	<u>1017064</u>	Mounting Bracket	2
6	<u>1017065</u>	Retainer, Headlight	1
7	<u>101987901</u>	Connector, Harness Assembly, Headlight	1
8	<u>101988101</u>	Bulb, Headlight	1
9	<u>101988201</u>	Lens, Headlight	1
10	1620	Screw, #10-16 X 0.75 Pan-Head Tap	2
11	<u>101988002</u>	Headlight Assy, Passenger-Side Single Beam (includes items 12 through 20)	1
12	<u>1016879</u>	Headlight Bezel, Right	1
13	<u>1017</u>	Nut, #10-24 Stainless-Steel Hex Machine	2
14	<u>1017062</u>	Turn Signal Lens Assy	1
15	<u>1017064</u>	Mounting Bracket	2
16	<u>1017065</u>	Retainer, Headlight	1
17	<u>101987901</u>	Connector, Harness Assembly, Headlight	1
18	<u>101988101</u>	Bulb, Headlight	1
19	<u>101988201</u>	Lens, Headlight	1
20	1620	Screw, #10-16 X 0.75 Pan-Head Tap	2

4
G
E

4
G
E

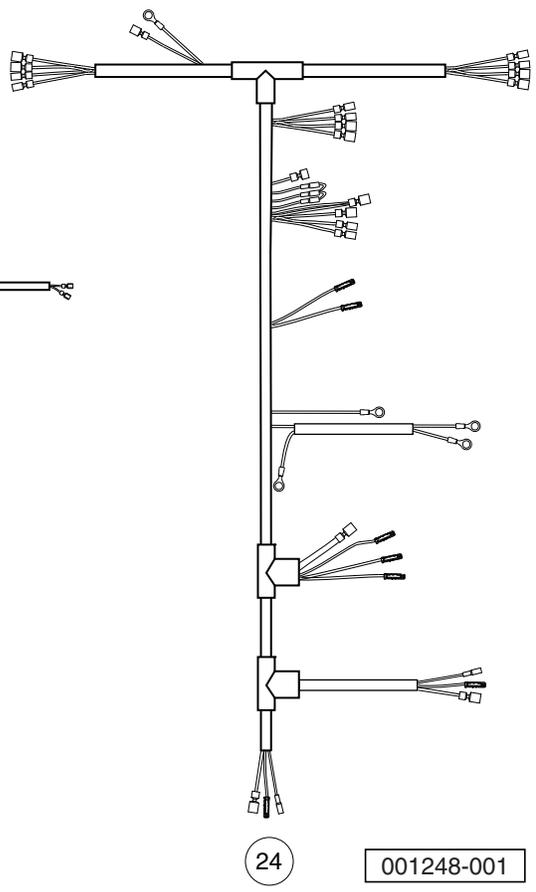
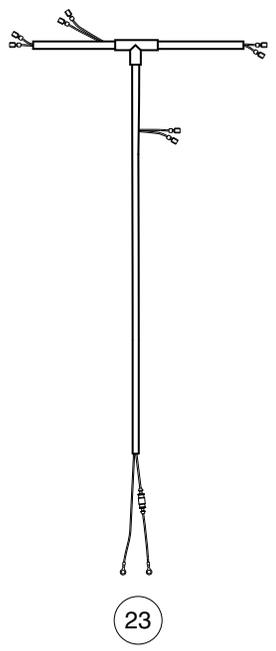
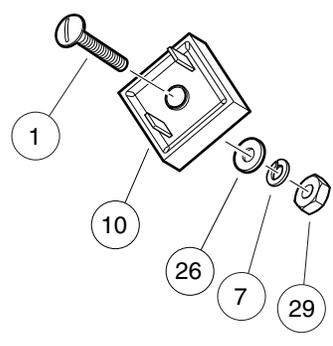
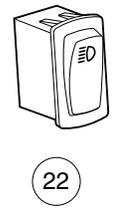
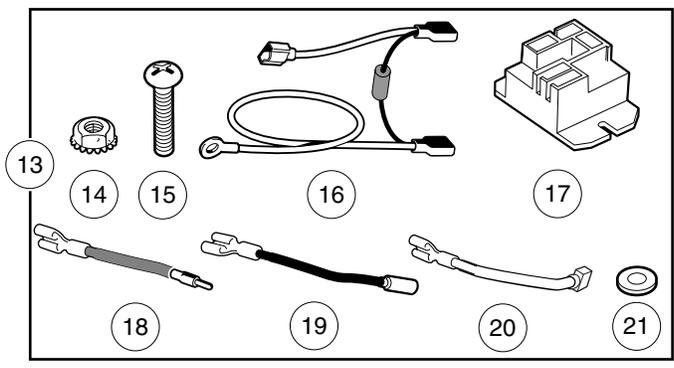
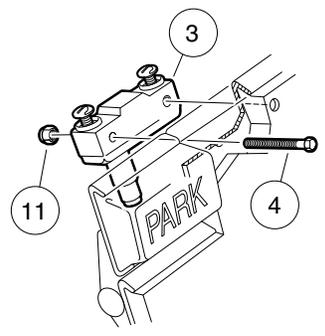
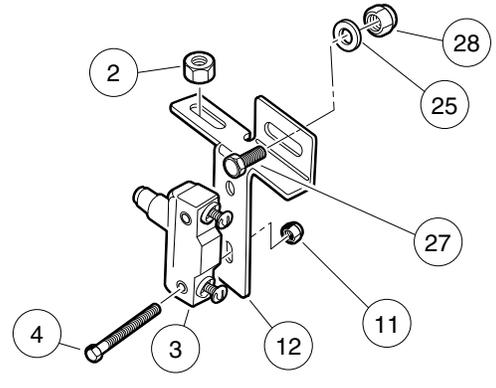
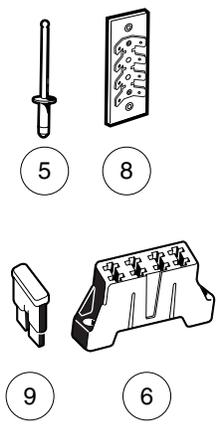

001248-001

LIGHTING SYSTEM COMPONENTS – XRT800/810/850 GASOLINE VEHICLES

ITEM	PART NO.	DESCRIPTION	QTY
		1 2 3 4	
1	<u>1010909</u>	Screw, #10-32 X 1.25 Rd Hd Mch	1
2	<u>1011280</u>	Locknut, 5/16-18	1
3	<u>1011439</u>	Switch, Limit	2
4	<u>1011557</u>	Screw, #6-32 X 1.00 Hex-Head Machine	4
5	<u>1013357</u>	Rivet, 5/32 Aluminum Pop	2
6	<u>1015741</u>	Fuse Block	1
7	<u>1016</u>	Lockwasher, #10 Split	1
8	<u>1016356</u>	Terminal Block with Insulator	1
9	<u>1016423</u>	Fuse, 20-Amp	3
10	<u>1017721</u>	Limiter, Voltage	1
11	<u>101932201</u>	Locknut, #6-32 Nylon	4
12	<u>101957101</u>	Bracket, Brake Light Switch	1
13	<u>102198701</u>	Brake Relay Kit - 12v (includes items 14 through 21)	1
14	<u>1011229</u>	Locknut, #6-32 Whiz	2
15	<u>1017853</u>	Screw, #6-32 X 0.75 Hex-Head Machine	2
16	<u>101914401</u>	Assembly, Voltage Suppressor	1
17	<u>102199001</u>	Relay, 12-Volt	1
18	<u>102199201</u>	Wire Asm #18 Brown	1
19	<u>102199301</u>	Wire Asm #18 Black	1
20	<u>102199401</u>	Wire Asm #18 Black	1
21	<u>7591</u>	Washer, #6, Flat	2
22	<u>102869401</u>	Switch, Rocker, Light	1
23	<u>103255601</u>	Wire Harness, Headlights-Only, CA, Gas	1
24	<u>103256901</u>	Wire Harness, Lighting, CA2	1
25	<u>1241</u>	Washer, 5/16 Type A Flat	1
26	<u>183</u>	Washer, #10, Type A, Flat	1
27	<u>7173</u>	Screw, 5/16-18 X 0.75, Hex-Head Cap	1
28	<u>7473</u>	Locknut, 5/16-18 Nylon Insert	1
29	<u>7893</u>	Nut, #10-32 Hex	1
Note: Use item 23 for headlights only. NOTE 2: Use item 24 for headlights and taillights. NOTE 3: Items 23 and 24 are used in many different models.			

4
G
E

4
G
E

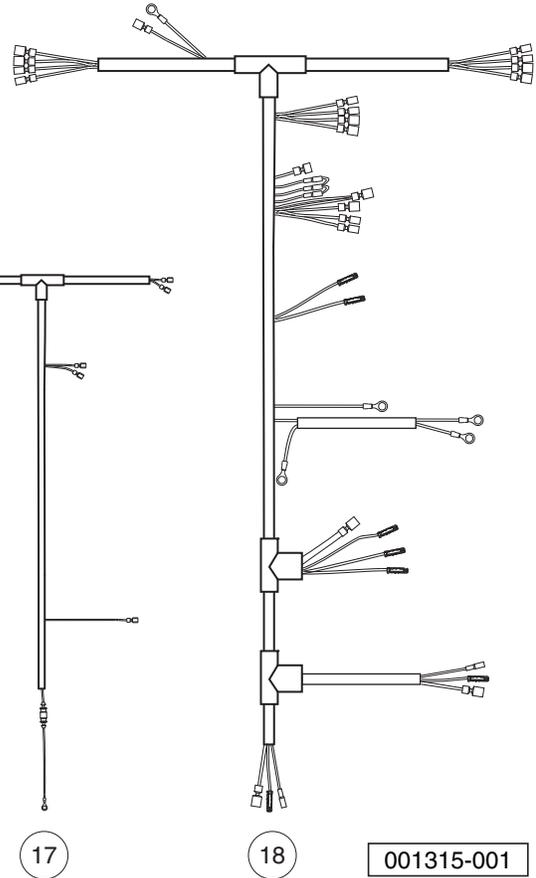
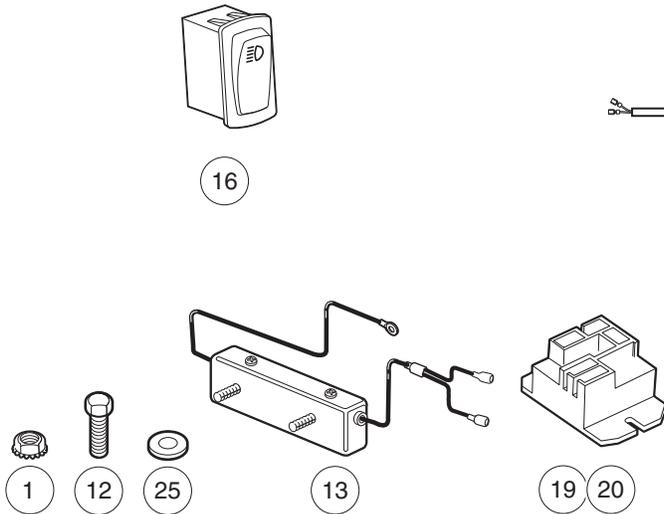
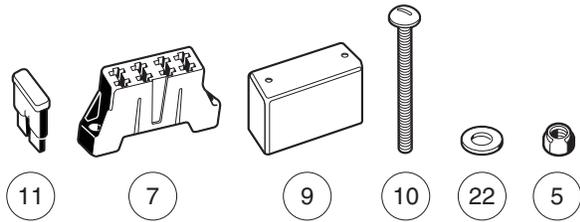
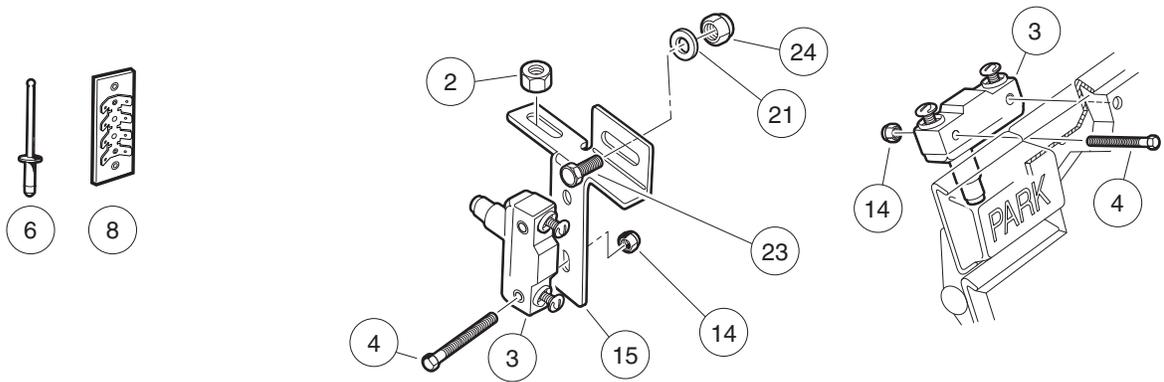

001315-001

LIGHTING SYSTEM COMPONENTS – XRT850 ELEC. WITH POWERDRIVE CHARGER

ITEM	PART NO.	DESCRIPTION	QTY
		1 2 3 4	
1	<u>1011229</u>	Locknut, #6-32 Whiz	2
2	<u>1011280</u>	Locknut, 5/16-18	1
3	<u>1011439</u>	Switch, Limit	2
4	<u>1011557</u>	Screw, #6-32 X 1.00 Hex-Head Machine	4
5	<u>1012438</u>	Locknut, #10-24 Nylon Insert	2
6	<u>1013357</u>	Rivet, 5/32 Aluminum Pop	2
7	<u>1015741</u>	Fuse Block	1
8	<u>1016356</u>	Terminal Block with Insulator	1
9	<u>1016363</u>	Fuse Block Cover	1
10	<u>1016366</u>	Screw, #10-24 X 3.0 Pan-Head Machine	2
11	<u>1016423</u>	Fuse, 20-Amp	3
12	<u>1017853</u>	Screw, #6-32 X 0.75 Hex-Head Machine	2
13	<u>101810501</u>	Limiter, Voltage	1
14	<u>101932201</u>	Locknut, #6-32 Nylon	4
15	<u>101957101</u>	Bracket, Brake Light Switch	1
16	<u>102869401</u>	Switch, Rocker, Light	1
17	<u>103255701</u>	Wire Harness, Headlights-Only, CA, Electric	1
18	<u>103257001</u>	Wire Harness, Lighting	1
19	<u>103414901</u>	Kit, Relay, 48v 30a W/instr (includes item 20)	1
20	<u>103397901</u>	Relay, Spst No, 48v 30a, Pmt	1
21	<u>1241</u>	Washer, 5/16 Type A Flat	1
22	<u>183</u>	Washer, #10, Type A, Flat	4
23	<u>7173</u>	Screw, 5/16-18 X 0.75, Hex-Head Cap	1
24	<u>7473</u>	Locknut, 5/16-18 Nylon Insert	1
25	<u>7591</u>	Washer, #6, Flat	2
<p>Note: Use item 17 for headlights only. NOTE 2: Use item 18 for headlights and taillights. NOTE 3: Items 17 and 18 are used in many different models.</p>			

4
G
E

4
G
E

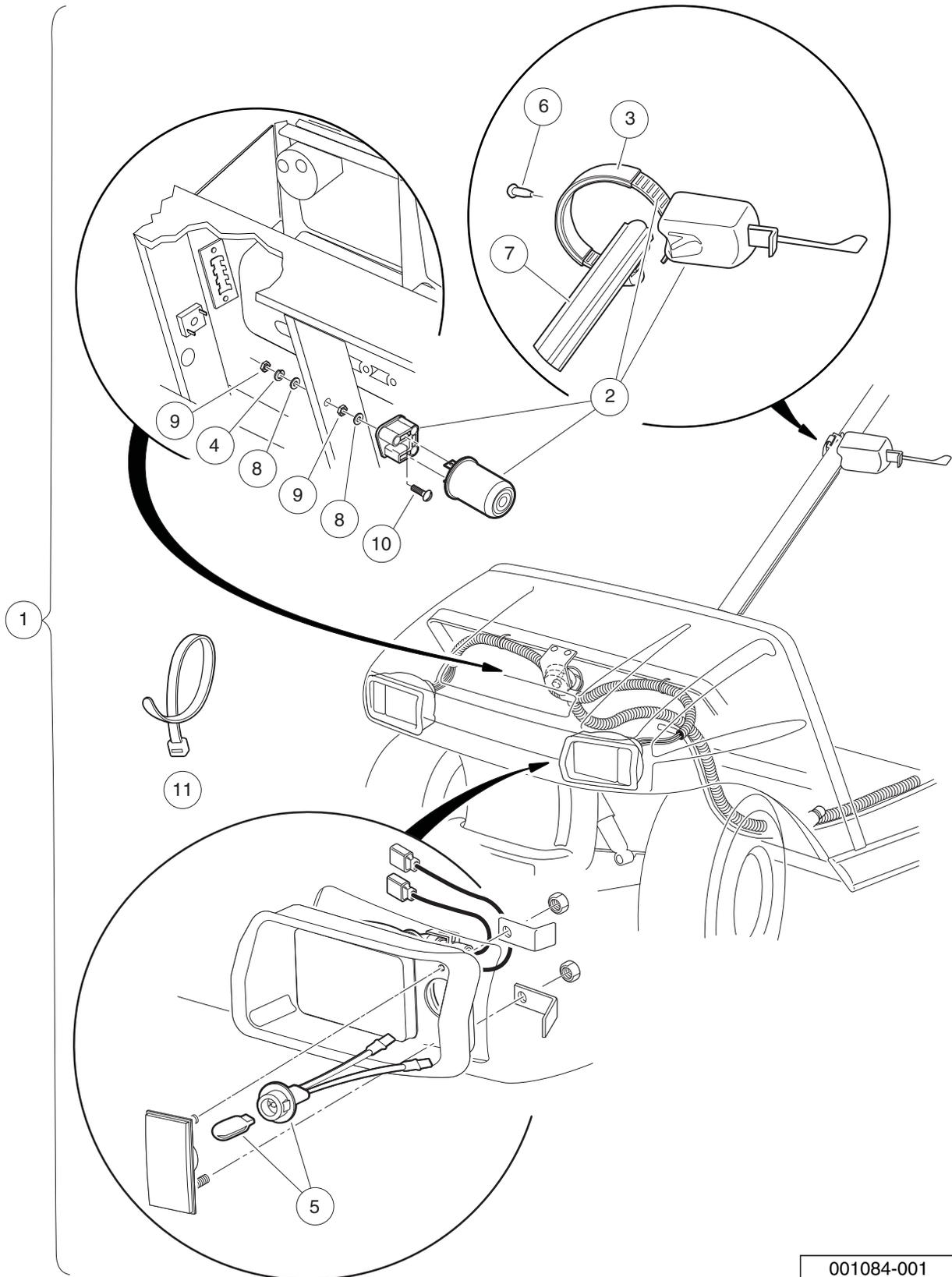

001084-001

TURN SIGNAL KIT – DS AND UTILITY GASOLINE AND ELECTRIC VEHICLES

ITEM	PART NO.	DESCRIPTION	QTY
		1 2 3 4	
1	101707402	Turn Signal Conversion Kit (includes items 2 through 11)	1
2	<u>1011590</u>	Switch Sub-assy, Turn Signal	1
3	N/A	Strap, Extrusion	1
4	<u>1016</u>	Lockwasher, #10 Split	1
5	<u>1017075</u>	Socket & Lamp Assembly	2
6	<u>1017724</u>	Rivet, Plastic	1
7	<u>102529201</u>	Wire Cover, Steering Column	1
8	<u>183</u>	Washer, #10, Type A, Flat	2
9	<u>7893</u>	Nut, #10-32 Hex	2
10	8104	Screw, #10-32 X .75 Rd Hd Mach	1
11	<u>8990</u>	Tie Wrap, 8" Nylon	1

4
G
E

4
G
E

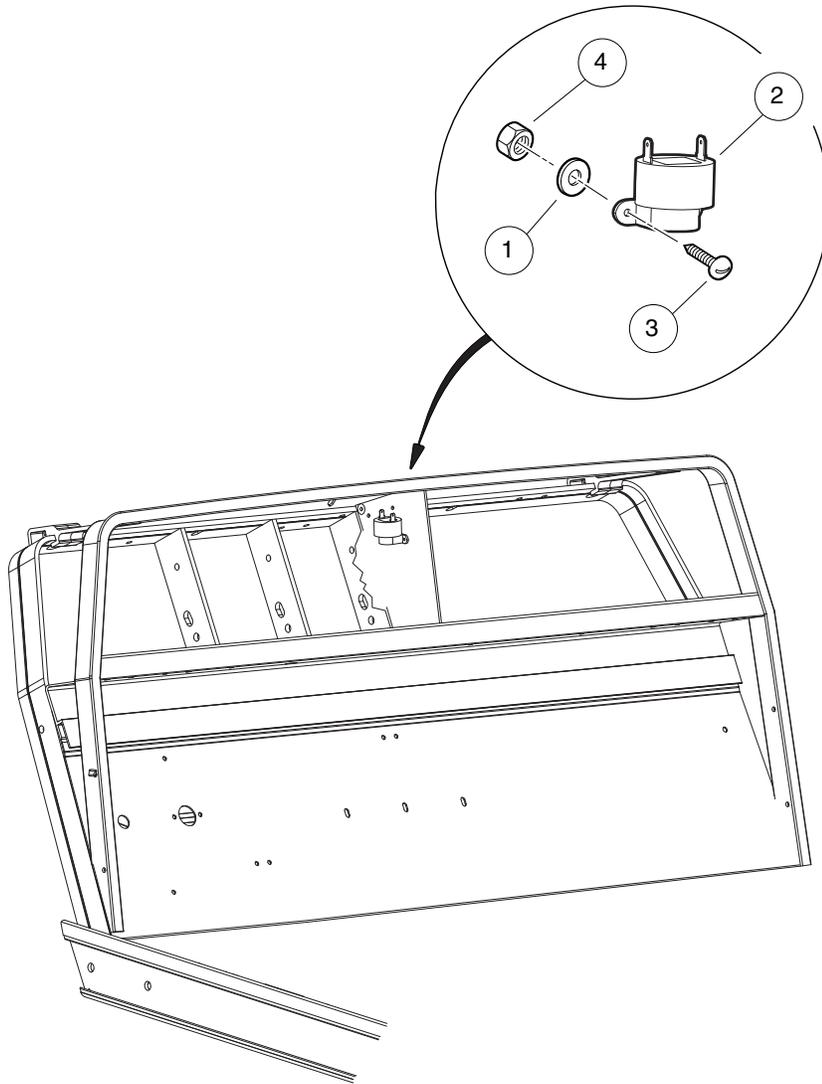

000363-001

REVERSE BUZZER

ITEM	PART NO.	DESCRIPTION	QTY
		1 2 3 4	
1	1012431	Washer, #4 Flat	1
2	<u>1016851</u>	Buzzer, Reverse (9-48 VDC)	1
3	<u>8056</u>	Screw, #4-40 X 0.75 Round-Head Machine	1
4	<u>8057</u>	Nut, #4-40 Hex Machine	1

4

G

E

4
G
E

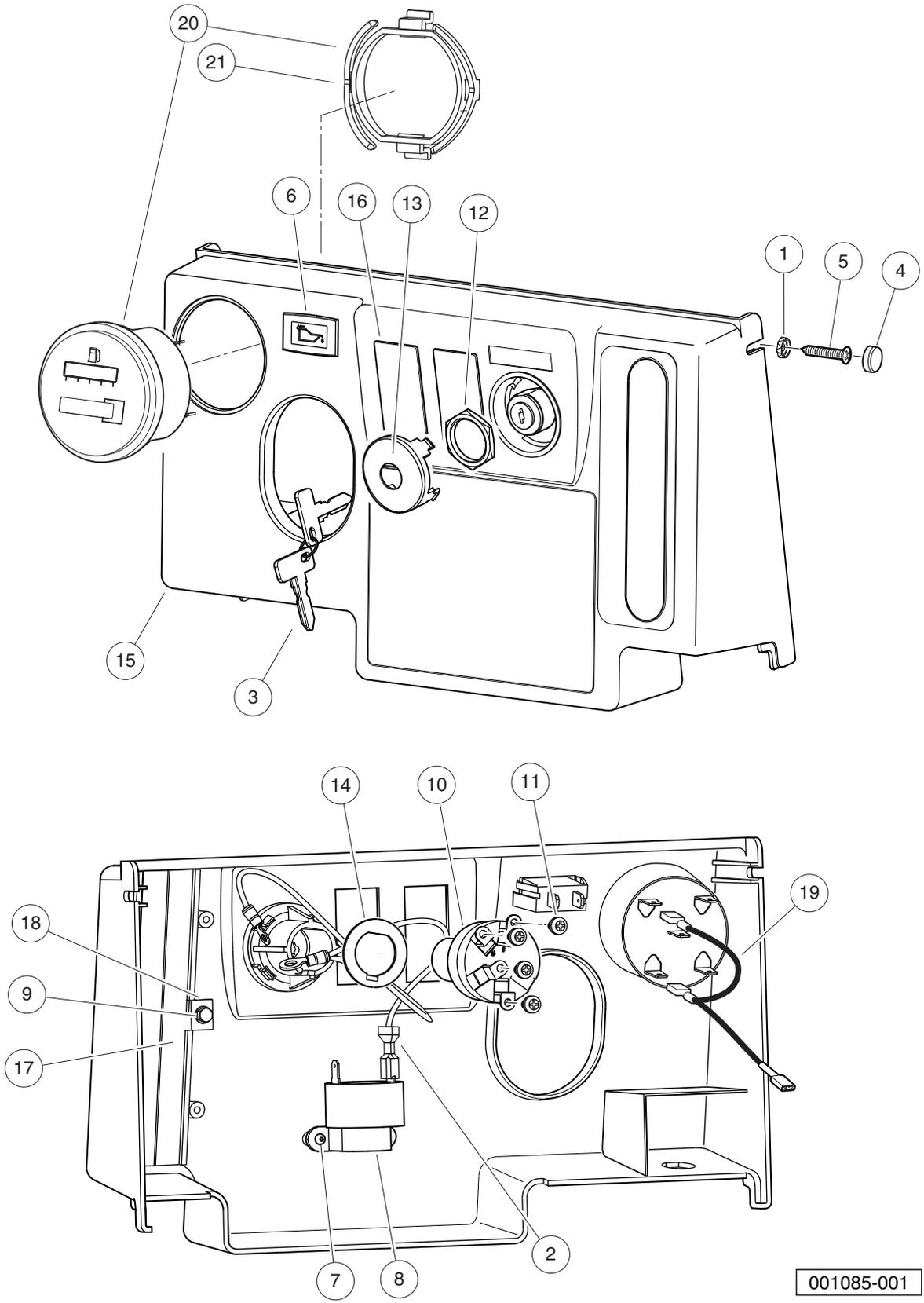

001085-001

INSTRUMENT PANEL – TURF/CA 1, 2, 252, AND TURF 6 GAS

ITEM	PART NO.	DESCRIPTION	QTY
		1 2 3 4	
1	1011382	Washer, #10 Pan-Head Screw	2
2	1012396	Wire Assy #18 Black	1
3	<u>1012505</u>	Keys (set of 2)	1
4	<u>1013494</u>	Cover, Screw Head	2
5	<u>1015528</u>	Screw, #10 x 1-1/4 Phillips Head	2
6	<u>1016630</u>	Light, Oil	1
7	<u>1016849</u>	Screw, #4-24 X 0.33, Pan-Head, Machine	2
8	<u>1016851</u>	Buzzer, Reverse (9-48 VDC)	1
9	<u>101804301</u>	Screw, #8 X 0.500, Hex-Head Hi-Lo	2
10	<u>101826301</u>	Key Switch, 12-Volt, Off/On	1
11	101830601	Screw and Washer Assembly	4
12	<u>101830701</u>	Nut, Key Switch	1
13	<u>101834502</u>	Cap, Black Key Switch	1
14	<u>101851101</u>	Washer, Key Switch	1
15	<u>102977001</u>	Panel, Dash, Center, Gas (Instrument Panel)	1
16	<u>103180101</u>	Cover, Hole, Switch, Rocker	2
17	<u>103199001</u>	Brush, Closeout, FNR	2
18	<u>103199101</u>	Washer, Retaining, Brush, FNR	2
19	<u>103348501</u>	Asm, Wire Meter, F-h Jumper	1
20	<u>103348601</u>	Gauge, Fuel-hour,sep Gnd,utl (includes item 21)	1
21	<u>103348201</u>	Clip, Meter, Round	1

4
G
E

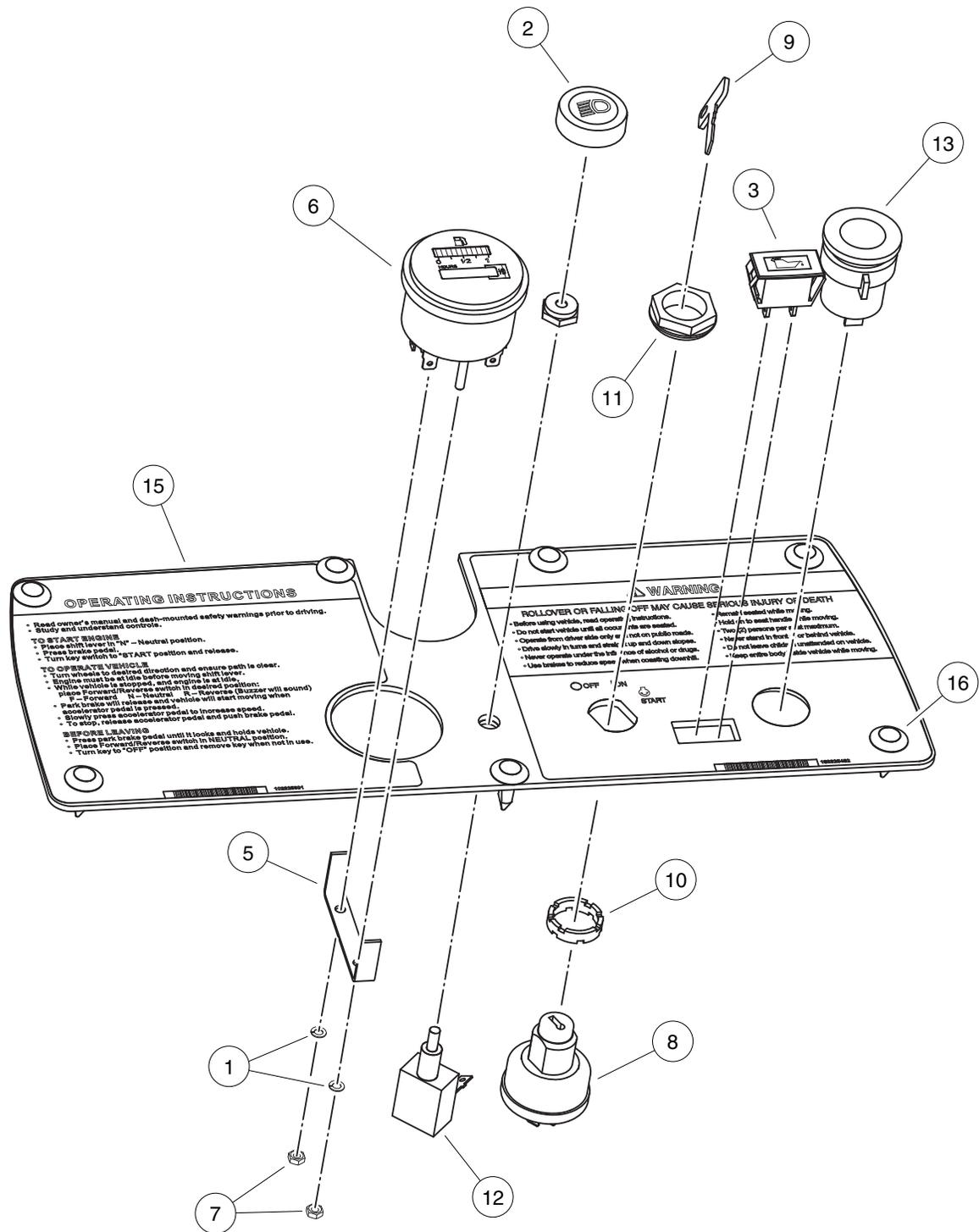

000232-001

INSTRUMENT PANEL – GASOLINE VEHICLE

ITEM	PART NO.	DESCRIPTION	QTY
		1 2 3 4	
1	<u>1012986</u>	Lockwasher, M4	2
2	<u>1013857</u>	Knob, Light Switch	1
3	<u>1016630</u>	Light, Oil	1
4	<u>101990703</u>	Gauge, Fuel/Hour, with Bracket (includes items 5 and 6)	1
5	102025901	Bracket, Fuel Gauge/Hour Meter	1
6	N/A	Gauge, Fuel/Hour	1
7	<u>101991101</u>	Nut, M4-0.7	2
8	<u>102044702</u>	Key Switch 12v Key Start	1
9	102044801	Key Set	1
10	<u>102051601</u>	Spacer, Keyswitch	1
11	<u>102051701</u>	Nut, Key Switch	1
12	<u>102051901</u>	Switch, Light	1
13	<u>102198001</u>	Receptacle, Accessory	1
14	<u>102804501</u>	Panel, Instrument	1
15	<u>102804502</u>	Panel, Instrument (with 12-Volt Accessory Outlet Cutout)	1
16	<u>102967901</u>	Rivet, Removable, Tuflok 1/4"	7

4
G
E

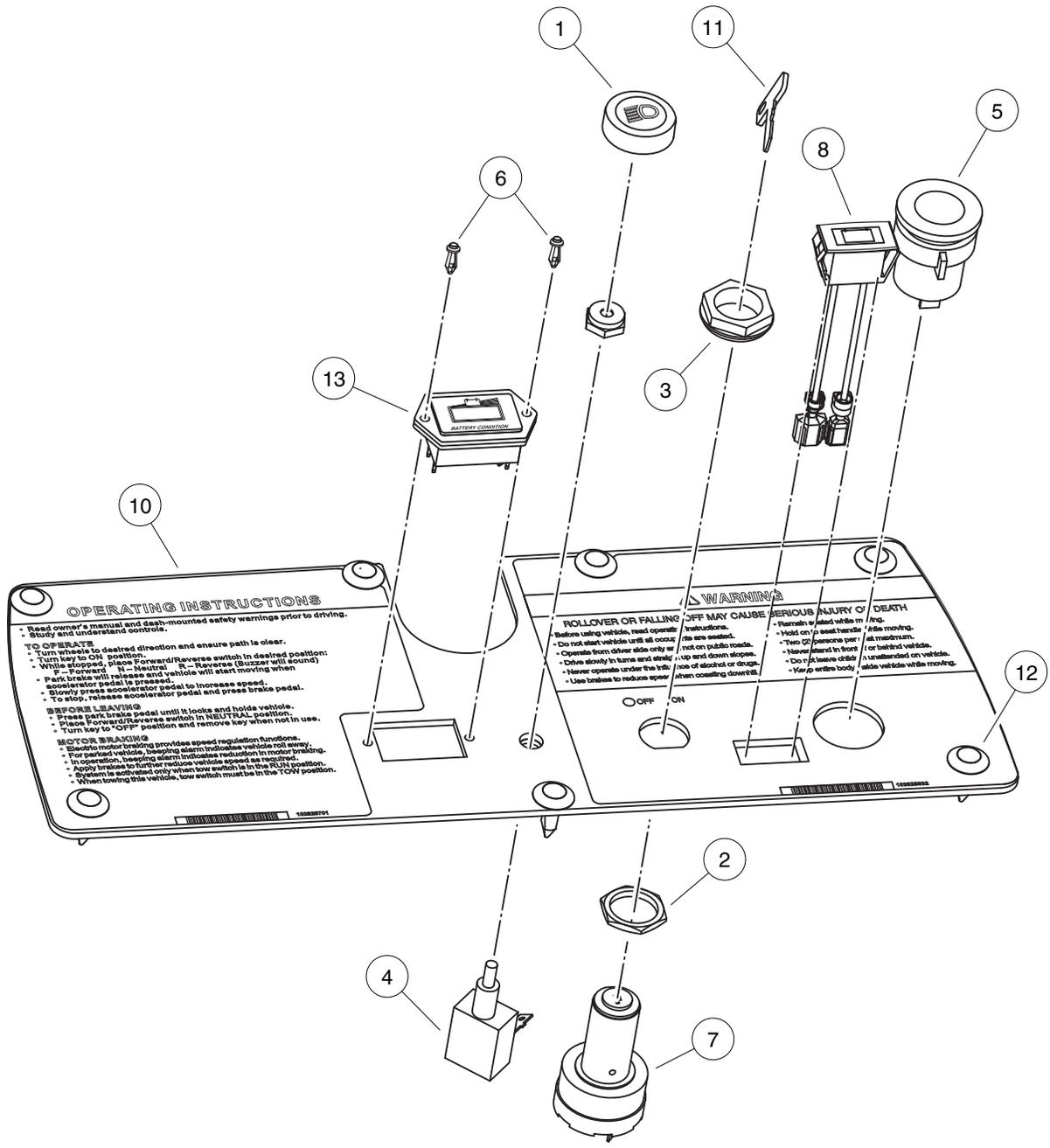

000231-001

INSTRUMENT PANEL – ELECTRICAL

ITEM	PART NO.	DESCRIPTION	QTY
		1 2 3 4	
1	<u>1013857</u>	Knob, Light Switch	1
2	<u>101830701</u>	Nut, Key Switch	1
3	<u>102051701</u>	Nut, Key Switch	1
4	<u>102051901</u>	Switch, Light	1
5	<u>102198001</u>	Receptacle, Accessory	1
6	<u>102499001</u>	Rivet, Micro Tuflok	2
7	<u>102508601</u>	Key Switch, Electric	1
8	<u>102508701</u>	Light, Battery	1
9	<u>102804503</u>	Panel, Instrument	1
10	<u>102804504</u>	Panel, Instrument (With 12-Volt Accessory Outlet Cutout) *	1
11	<u>102830801</u>	Set, Key	1
12	<u>102967901</u>	Rivet, Removable, Tuflok 1/4"	7
13	<u>103200701</u>	Battery Condition Indicator - 48V	1
<p>Note: Items marked with an asterisk (*) are to be used only on vehicles equipped with a 12-volt accessory outlet. This item to be used only in vehicles equipped with accessory outlets.</p>			

4
G
E

4
G
E

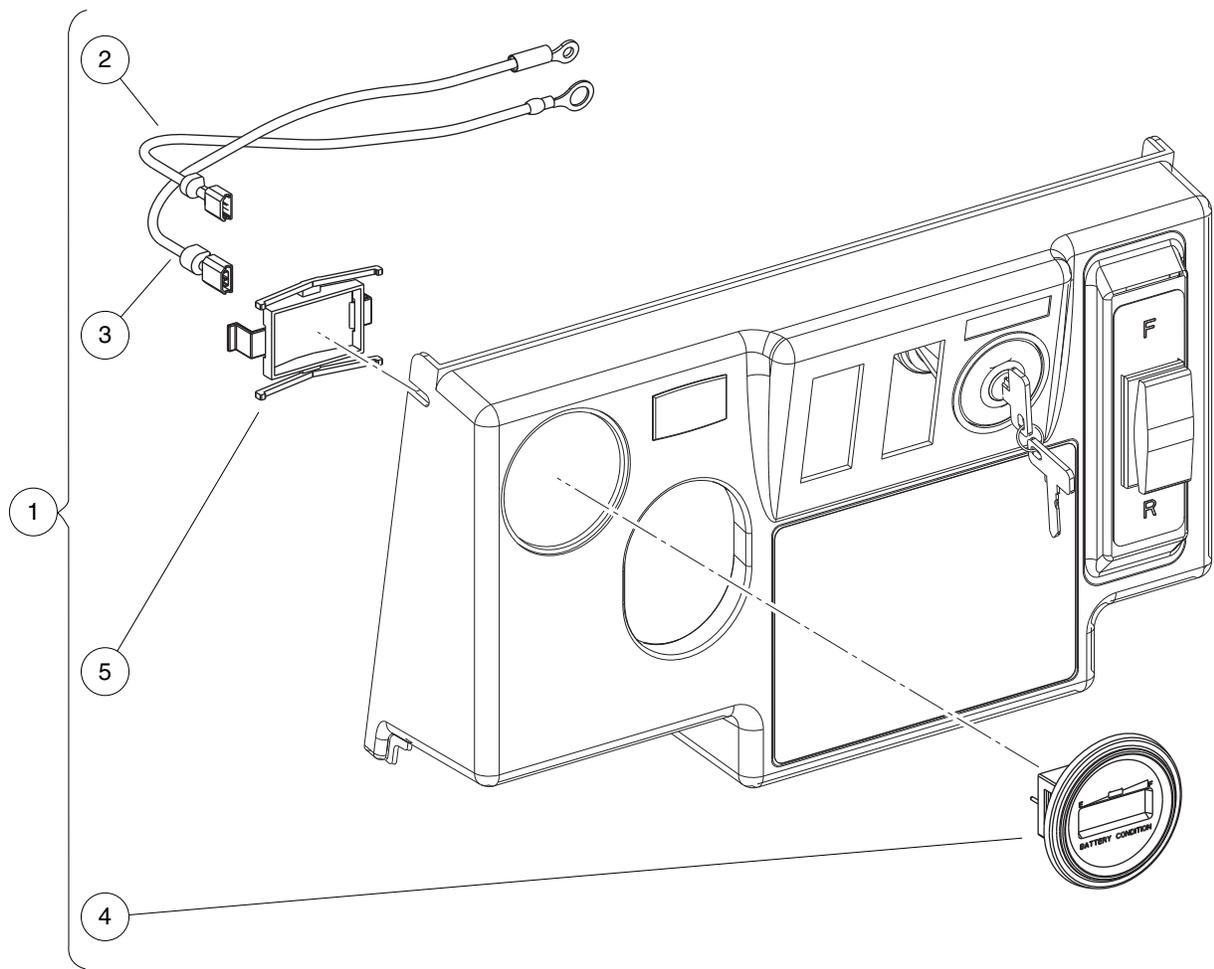

000817-002

BATTERY CONDITION INDICATOR – ELECTRIC VEHICLES

ITEM	PART NO.	DESCRIPTION	QTY
		1 2 3 4	
1	<u>103257603</u>	Kit, Gauge, Battery Condition Indicator (includes items 2 through 4)	1
2	<u>103257701</u>	Wire Asm, #18 Black, 2565mm	1
3	<u>103257801</u>	Wire Asm, #16 Red, 330mm	1
4	<u>103354401</u>	Gauge, Battery Cond Ind, Rnd (includes item 5)	1
5	<u>103348202</u>	Clip, Bci, Round	1

4

G

E

4
G
E

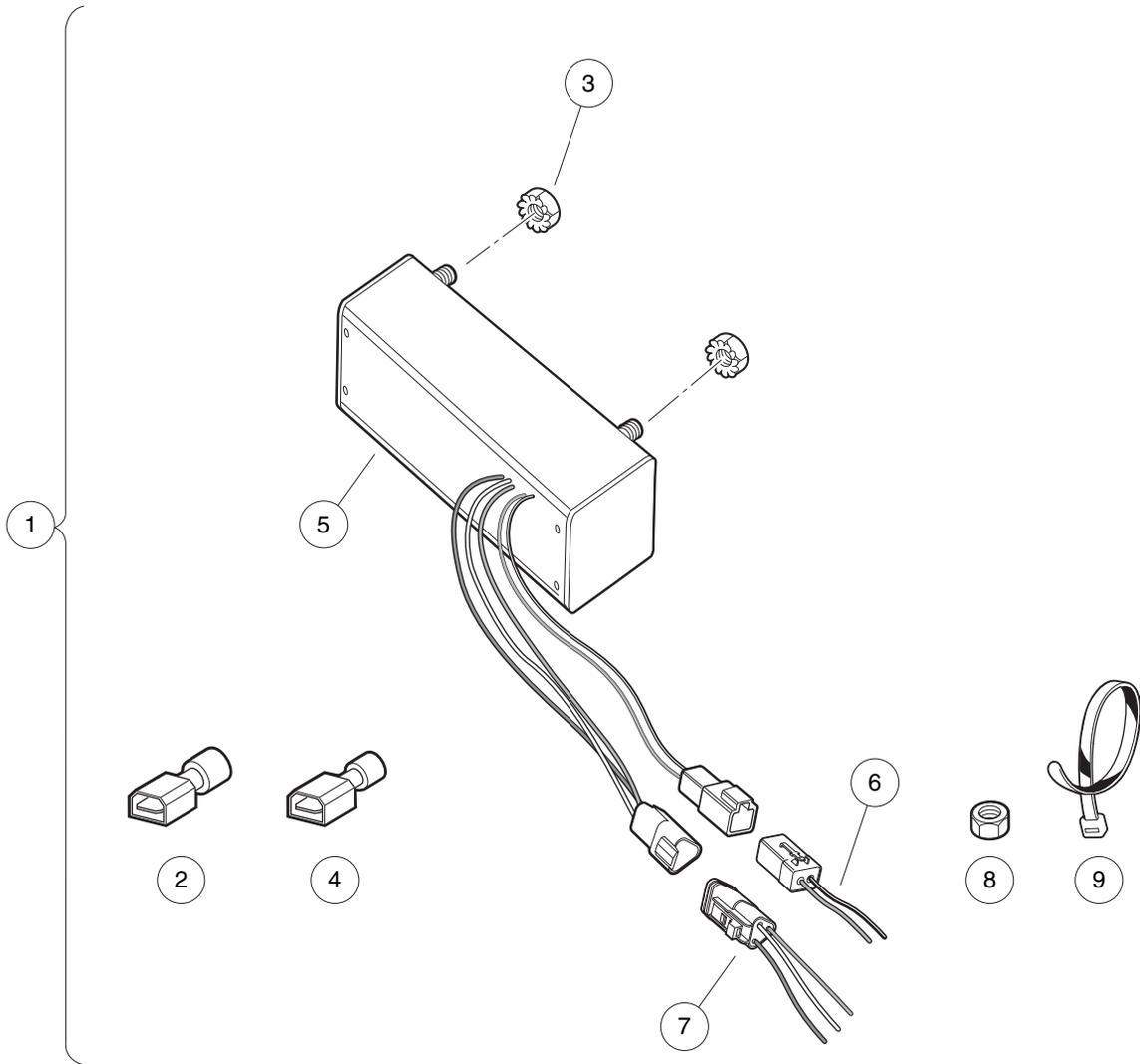

001271-001

DC CONVERTER – IQ SYSTEM ELECTRIC VEHICLE

ITEM	PART NO.	DESCRIPTION	QTY
		1 2 3 4	
1	<u>102357501</u>	Kit, DC/DC Converter (includes items 2 through 9)	1
2	<u>1016365</u>	Terminal, 1/4" Male Quick Disconnect	1
3	<u>101835601</u>	Locknut, 1/4-20 Hex Whiz	2
4	N/A	Terminal, 1/4" Male Quick Disconnect	1
5	102352201	Converter , Dc -non Isolated	1
6	<u>102354901</u>	Harness, Dc Converter - 12v	1
7	<u>102355001</u>	Harness, Dc Converter - 48v	1
8	<u>1242</u>	Nut, 5/16-18 Hex	1
9	<u>8990</u>	Tie Wrap, 8" Nylon	4

4
G
E

4

G

E

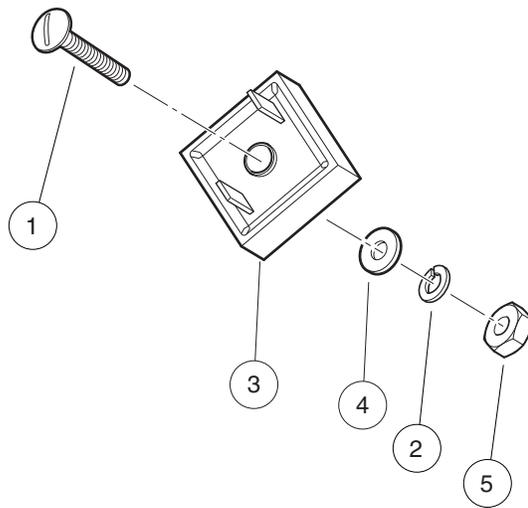

001091-001

VOLTAGE LIMITER – GASOLINE VEHICLE

ITEM	PART NO.	DESCRIPTION	QTY
		1 2 3 4	
1	<u>1010909</u>	Screw, #10-32 X 1.25 Rd Hd Mch	1
2	<u>1016</u>	Lockwasher, #10 Split	1
3	<u>1017721</u>	Limiter, Voltage	1
4	<u>183</u>	Washer, #10, Type A, Flat	1
5	<u>7893</u>	Nut, #10-32 Hex	1

4
G
E

4
G
E

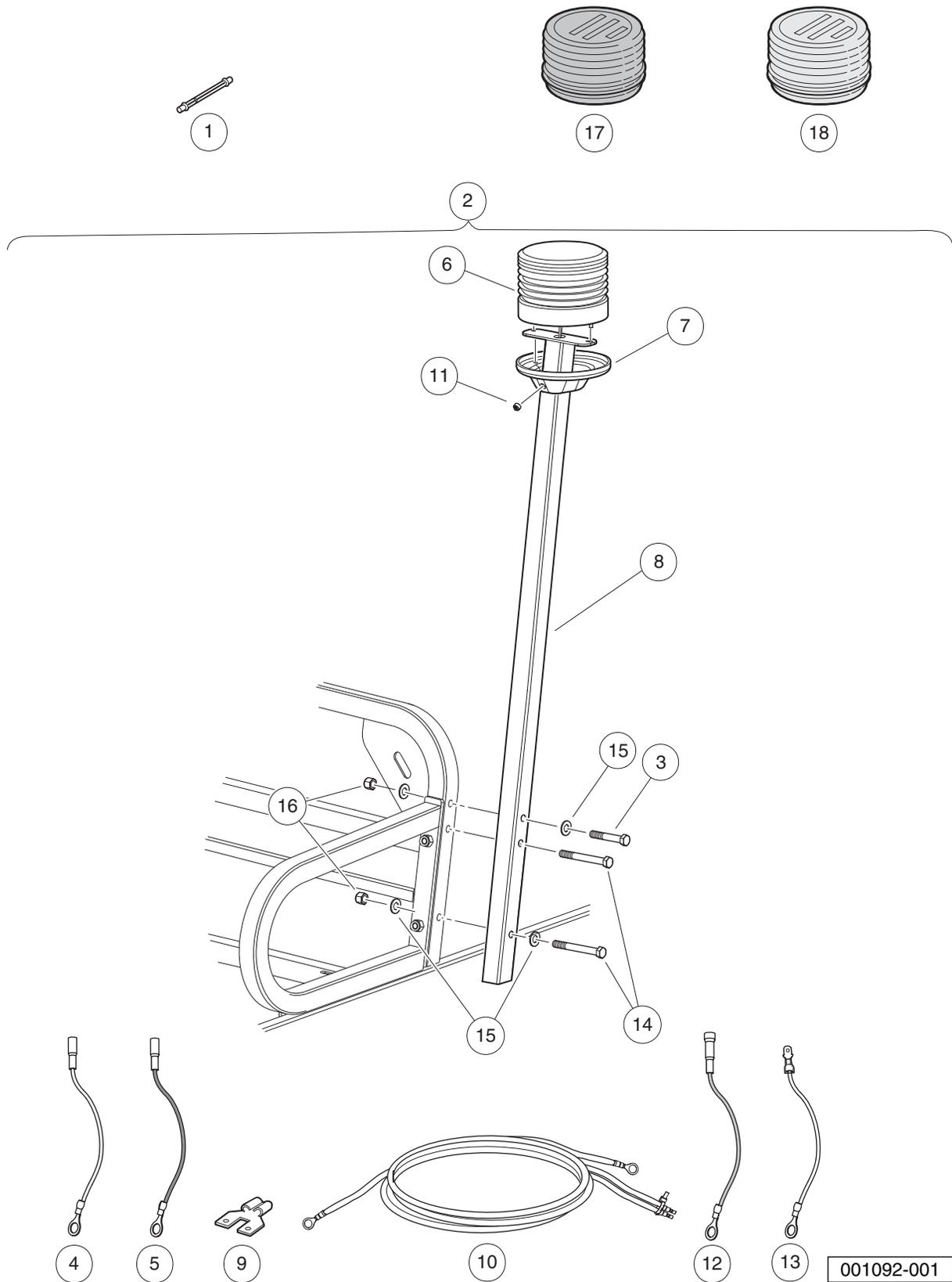

001092-001

STROBE LIGHT, POST-MOUNTED – GASOLINE VEHICLES

ITEM	PART NO.	DESCRIPTION	QTY
		1 2 3 4	
1	<u>1015526</u>	Bulb, Replacement, for Strobe Light	1
2	<u>1015765</u>	Safety Strobe Lht Post Mnt Gas (includes items 3 through 16)	1
3	<u>1013509</u>	Screw, 1/4-20 X 1.75 Hx Hd Cap	2
4	1015153	Wire Assembly #16 Yellow	1
5	1015154	Wire Assembly Blue Ca #16	1
6	<u>1015156</u>	Light Assembly, Strobe	1
7	1015157	Cover Plate Switch - Pole Ca	1
8	<u>1015160</u>	Pole Weldment Carryall	1
9	<u>1015162</u>	3/16 Tab Adapter Non-insul	1
10	<u>1015172</u>	Wire Harness Assy, Strobe Lght	1
11	<u>1015187</u>	Switch Assembly	1
12	1016837	Wire Assembly Red #18	1
13	1016929	Wire Assembly Black #16	1
14	<u>324</u>	Screw, 1/4-20 X 2.50 Hx Hd Cap	2
15	<u>332</u>	Washer, 1/4 Type A Narrow Flat	4
16	<u>8233</u>	Locknut, 1/4-20, Nylon Insert	2
17	<u>AM1243701</u>	Lens, Blue, for Strobe Light	1
18	<u>AM1243801</u>	Lens, Red, for Strobe Light	1

4
G
E

4
G
E

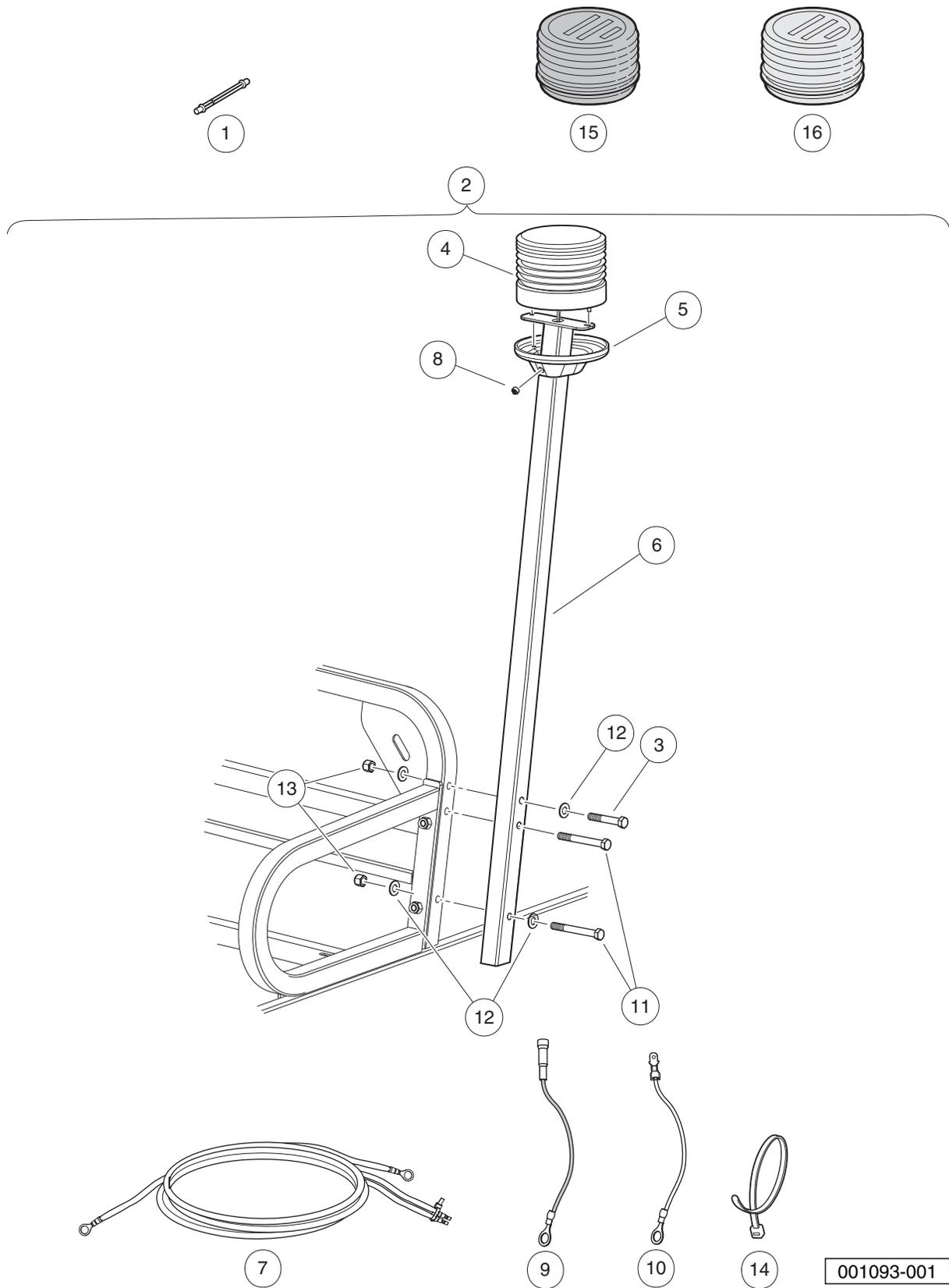

001093-001

STROBE LIGHT, POST-MOUNTED – ELECTRIC VEHICLES

ITEM	PART NO.	DESCRIPTION	QTY
		1 2 3 4	
1	<u>1015526</u>	Bulb, Replacement, for Strobe Light	1
2	<u>101814601</u>	Safety Strobe Lht & Post Mt El (includes items 3 through 14)	1
3	<u>1013509</u>	Screw, 1/4-20 X 1.75 Hx Hd Cap	2
4	<u>1015156</u>	Light Assembly, Strobe	1
5	1015157	Cover Plate Switch - Pole Ca	1
6	<u>1015160</u>	Pole Weldment Carryall	1
7	<u>1015172</u>	Wire Harness Assy, Strobe Lght	1
8	<u>1015187</u>	Switch Assembly	1
9	1016837	Wire Assembly Red #18	1
10	1016929	Wire Assembly Black #16	1
11	<u>324</u>	Screw, 1/4-20 X 2.50 Hx Hd Cap	2
12	<u>332</u>	Washer, 1/4 Type A Narrow Flat	4
13	<u>8233</u>	Locknut, 1/4-20, Nylon Insert	2
14	<u>8990</u>	Tie Wrap, 8" Nylon	4
15	<u>AM1243701</u>	Lens, Blue, for Strobe Light	1
16	<u>AM1243801</u>	Lens, Red, for Strobe Light	1

4
G
E

4
G
E

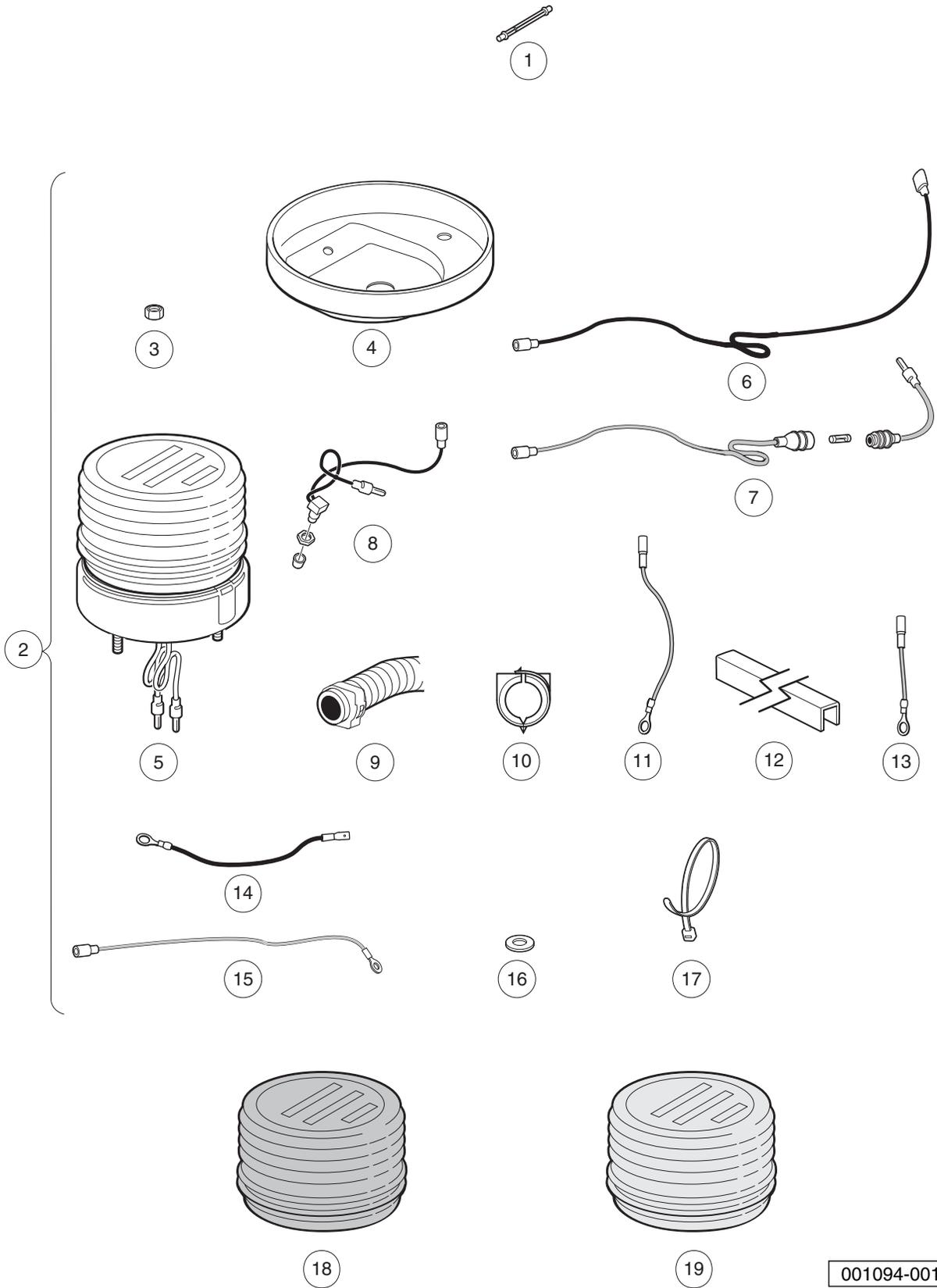

001094-001

STROBE LIGHT, CANOPY-MOUNTED

ITEM	PART NO.	DESCRIPTION	QTY
		1 2 3 4	
1	<u>1015526</u>	Bulb, Replacement, for Strobe Light	1
2	<u>AM1243501</u>	Kit, Roof Mounted Strobe Fd (includes items 3 through 17)	A/R
3	<u>1012438</u>	Locknut, #10-24 Nylon Insert	2
4	<u>1015010</u>	Cover Plate Switch	1
5	<u>1015156</u>	Light Assembly, Strobe	1
6	<u>1015167</u>	#16 Black Wire Asm	1
7	<u>1015170</u>	Wire Assembly #16	1
8	<u>1015187</u>	Switch Assembly	1
9	<u>1015768</u>	Split Convoluted Elec Conduit	11
10	<u>1015770</u>	Outlet Ring - .5 Diameter	5
11	<u>1016230</u>	Wire Asm #16 Red	1
12	<u>1016267</u>	Snap On Conduit Vert.	1
13	<u>1016287</u>	Wire Asm #16 Red	1
14	<u>1016929</u>	Wire Assembly Black #16	1
15	<u>101821601</u>	#18 Red Wire Assembly	1
16	<u>183</u>	Washer, #10, Type A, Flat	2
17	<u>8639</u>	Tie Wrap, 11" Nylon	8
18	<u>AM1243701</u>	Lens, Blue, for Strobe Light	A/R
19	<u>AM1243801</u>	Lens, Red, for Strobe Light	A/R

4
G
E

4

G

E

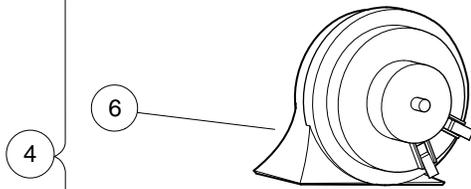
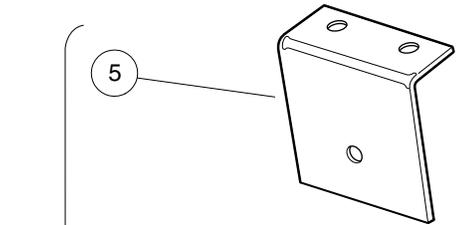
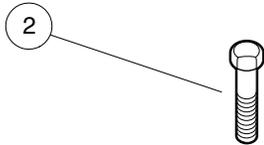
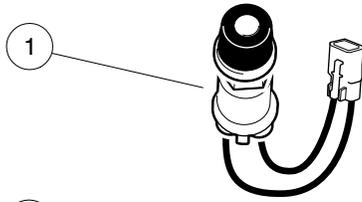

001095-001

HORN

ITEM	PART NO.	DESCRIPTION	QTY
		1 2 3 4	
1	<u>101969701</u>	Horn Button and Wire Assembly	1
2	304	Screw, 1/4-20 X 1.0 Hex-Head Cap	2
3	<u>332</u>	Washer, 1/4 Type A Narrow Flat	2
4	<u>4029</u>	Horn (includes items 5 through 9)	1
5	<u>1011825</u>	Horn Bracket	1
6	<u>1014530</u>	Horn, 12-VDC	1
7	<u>101955101</u>	Nut, M6 Hex	1
8	<u>7820</u>	Washer, 5/16 Internal-Tooth	1
9	8294	5/16 Ring Term.	1
10	<u>8233</u>	Locknut, 1/4-20, Nylon Insert	2

4
G
E

4
G
E

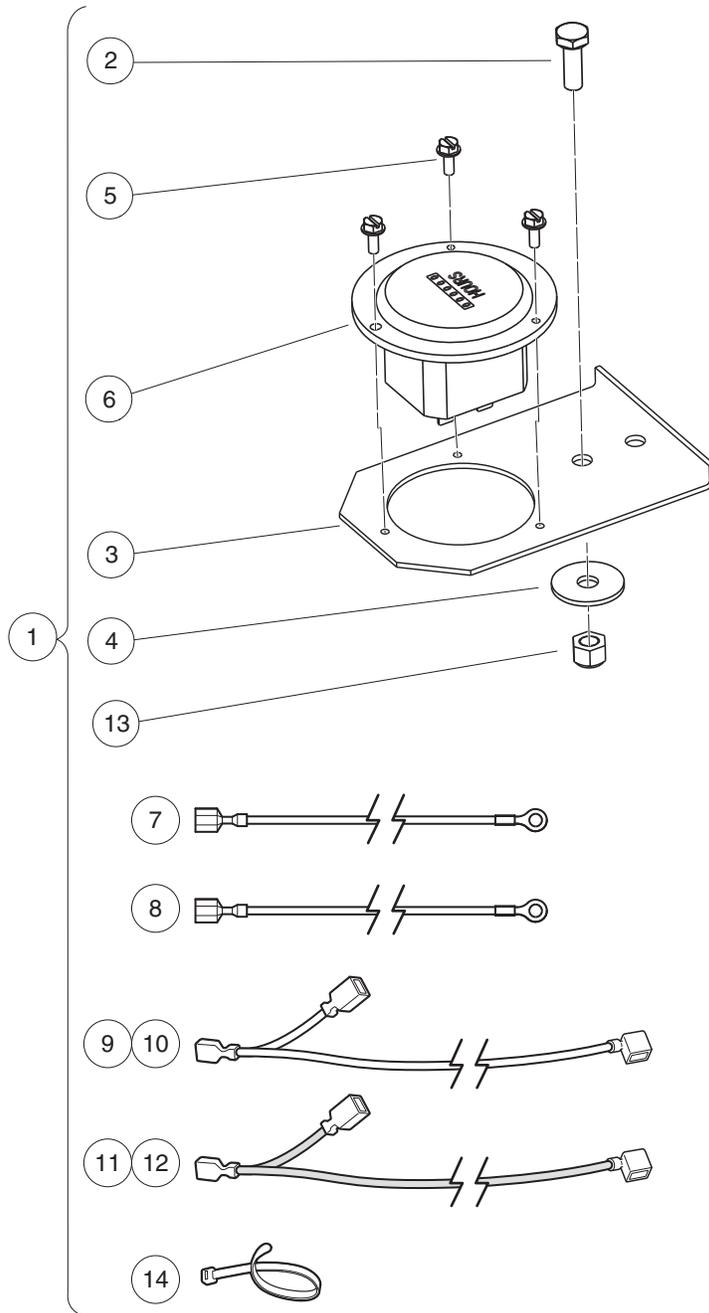

001096-001

HOUR METER – IQ SYSTEM AND IQ PLUS ELECTRIC VEHICLES

ITEM	PART NO.	DESCRIPTION	QTY
		1 2 3 4	
1	<u>1013579</u>	Kit, Hour Meter (includes items 2 through 14)	1
2	<u>1012285</u>	Screw, 1/4 X 0.625 Hex-Head	1
3	<u>1013547</u>	Hour Meter Bracket	1
4	<u>1014306</u>	Washer, 1/4" Type B Flat	1
5	<u>1014540</u>	Screw, #6-32 X 3/8 Taptite	3
6	N/A	Hour Meter	1
7	101881501	Wire Assembly Black #18	1
8	101881601	Wire Assembly Red #18	1
9	<u>101997802</u>	Wire Assembly #18 Yellow	1
10	<u>101997803</u>	Wire Asm #18 Yellow 31"	1
11	<u>101997902</u>	Wire Assembly #18 Red	1
12	<u>101997903</u>	Wire Asm # 18 Red 31"	1
13	<u>8233</u>	Locknut, 1/4-20, Nylon Insert	1
14	<u>8990</u>	Tie Wrap, 8" Nylon	1
		<p>Note: The kit includes components that apply to multiple vehicles. The installation instructions will specify which components are required for a specific model. After installation, discard components not used.</p>	

4
G
E

4
G
E

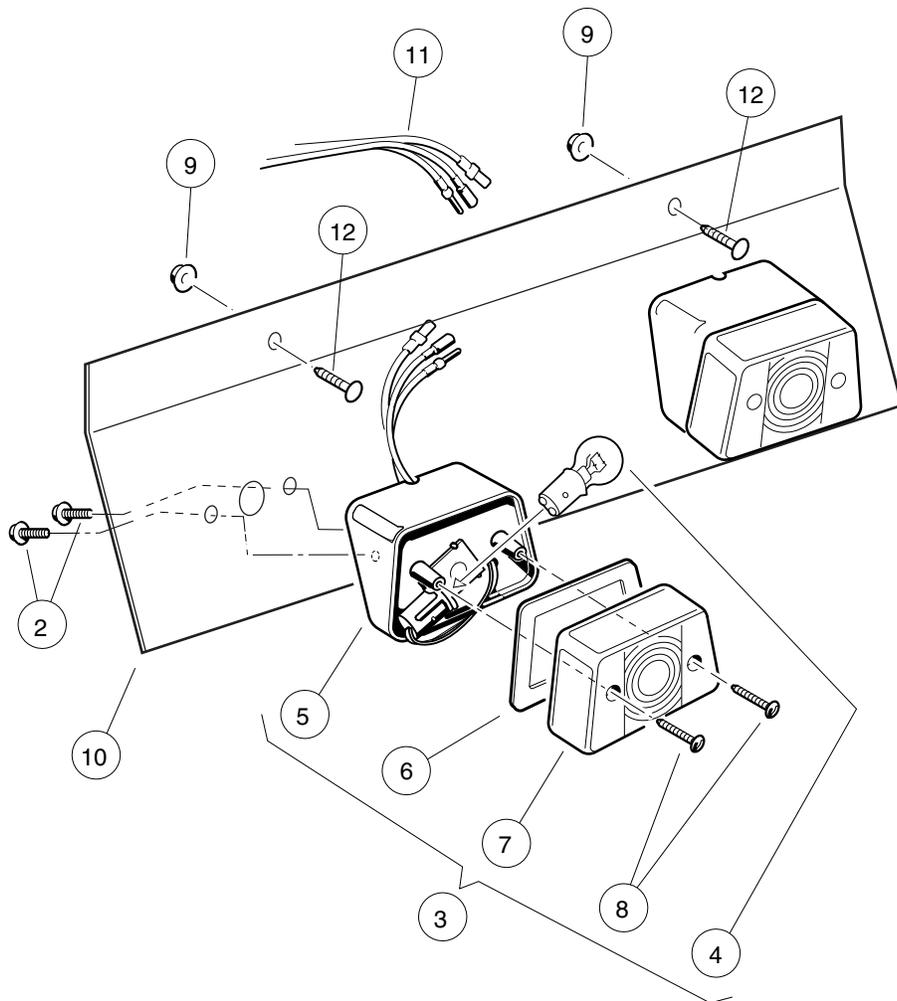

000348-009

TAILLIGHTS

ITEM	PART NO.	DESCRIPTION	QTY
		1 2 3 4	
1	<u>102852501</u>	Kit, Tail Lights (includes items 2 through 12)	1
2	<u>1015752</u>	Screw, #12-16 X 0.625, Hi-Lo	4
3	<u>1016717</u>	Light Assembly, Stop/Taillight (includes items 4 through 8)	2
4	<u>1011582</u>	Taillight Bulb	1
5	N/A	Housing, Taillight	1
6	N/A	Gasket, Taillight	1
7	N/A	Lens, Taillight	1
8	N/A	Screw, Taillight Lens	2
9	<u>101835601</u>	Locknut, 1/4-20 Hex Whiz	2
10	<u>102909901</u>	Support, Tail Light	1
11	<u>102911601</u>	Asm, Wire Harness	1
12	<u>7847</u>	Screw, 1/4-20 X 0.75 Hex-Head Cap	2
<p>Note: Taillights are optional for Carryall 242 and XRT 800 vehicles.</p>			

4
G
E

4

G

E

BRAKE SYSTEM

5
G
E

5
G
E

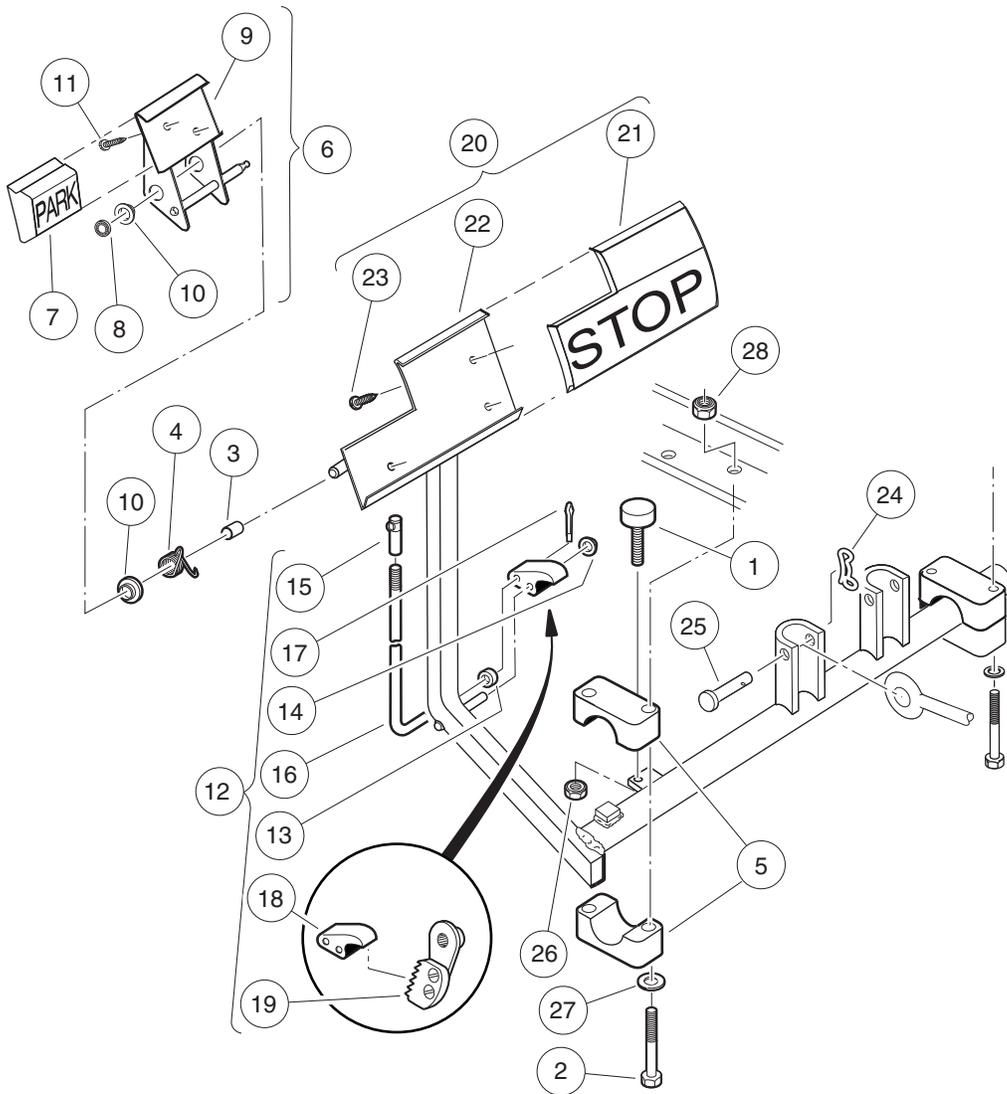

000187-001

BRAKE PEDAL ASSEMBLY

ITEM	PART NO.	DESCRIPTION	QTY
		1 2 3 4	
1	<u>1010878</u>	Bumper, Rubber	1
2	<u>1010921</u>	Screw, 5/16-18 X 2.50 Hex Cap	4
3	<u>1010927</u>	Hill Brake Spacer	1
4	<u>1010933</u>	Spring, Hill Brake Torsion	1
5	<u>1011402</u>	Package, Brake Mounting Block	1
6	<u>1011418</u>	Kit, Hill Brake Pedal (includes items 7 through 11)	1
7	<u>1013870</u>	Pad, Hill Brake	1
8	<u>1013876</u>	Pushnut, 3/8	1
9	N/A	Hill Brake Weld Assembly	1
10	<u>1032</u>	Bushing, Nylon	2
11	7716	Screw, #10-16 Type AB, Sheet Metal	2
12	<u>101187702</u>	Kit, Hill Brake Latch (includes items 13 through 19)	1
13	<u>1010805</u>	Sleeve, Hill Brake Rod	1
14	<u>1010877</u>	Pushnut, 3/8	1
15	1010932	Ball Joint, 1/4-28	1
16	N/A	Rod, Hill Brake	1
17	<u>1017029</u>	Pin, Cotter, 7/64 x 1/2 Stainless-Steel	1
18	N/A	Pawl, Hill Brake	1
19	101918501	Ratchet Assembly	1
20	<u>101878201</u>	Brake Pedal Kit (includes items 21 through 23)	1
21	<u>1013869</u>	Pad, Brake Pedal	1
22	N/A	Weldment, Brake Pedal, 2wr Std	1
23	7716	Screw, #10-16 Type AB, Sheet Metal	3
24	<u>102323101</u>	Pin, Bow Tie Locking	1
25	<u>102323201</u>	Pin, 3/8 X 1-5/16 Clevis	1
26	<u>1028</u>	Nut, 1/4-20 Hex	1
27	<u>1241</u>	Washer, 5/16 Type A Flat	4
28	<u>7473</u>	Locknut, 5/16-18 Nylon Insert	4

5
G
E

5
G
E

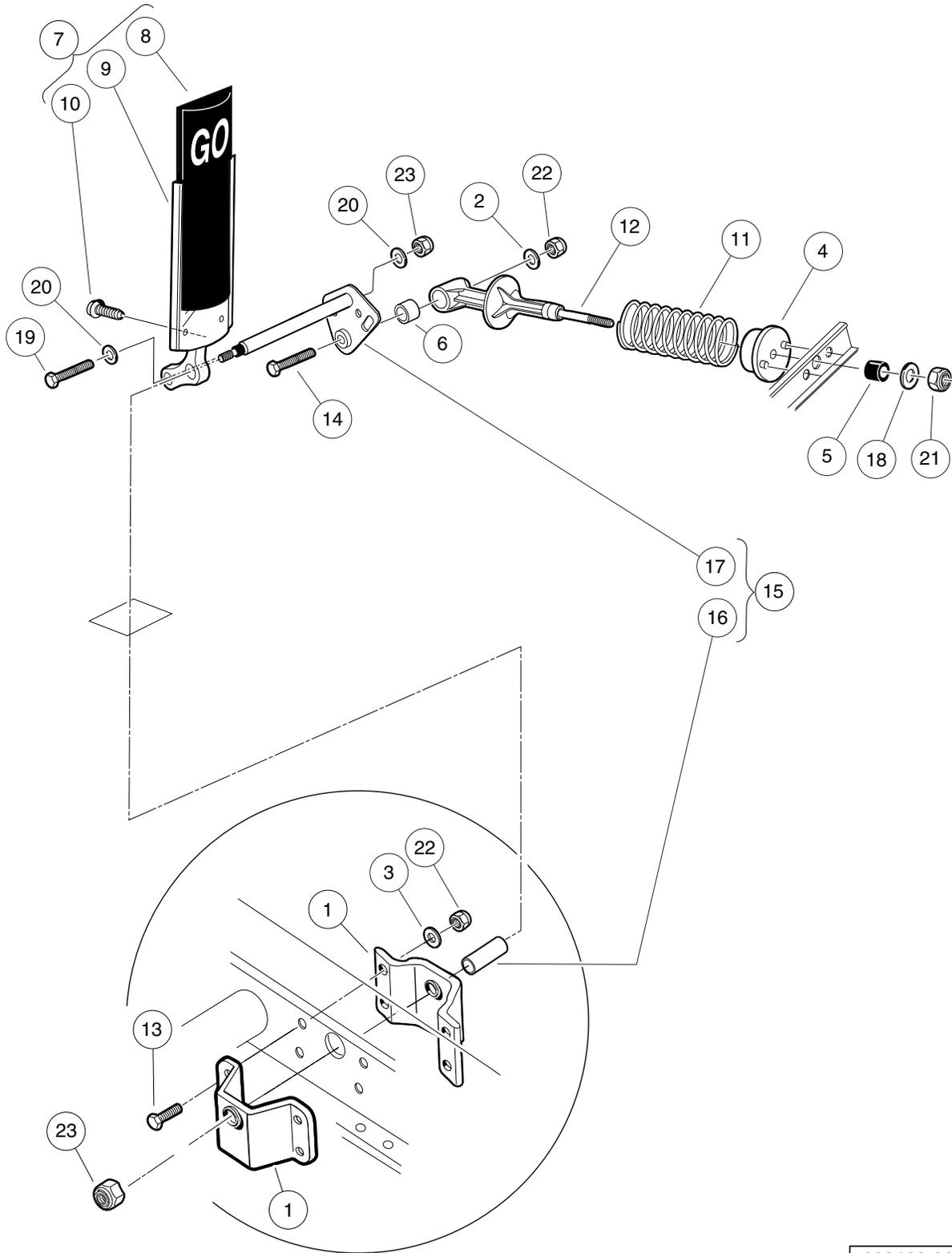

000188-007

ACCELERATOR PEDAL ASSEMBLY – ELECTRIC VEHICLES WITH MCOR

ITEM	PART NO.	DESCRIPTION	QTY
		1 2 3 4	
1	<u>1011694</u>	Accelerator Bracket and Bearing Assembly	2
2	<u>1011931</u>	Washer, 1/4 Flat	1
3	<u>1014007</u>	Washer, 1/4, Flat	4
4	<u>1017378</u>	Cup, Spring	1
5	<u>1017380</u>	Bumper, Spring Return	1
6	<u>1017424</u>	Bearing, Pivot Support	1
7	<u>1017696</u>	Sub Asm, Accelerator Pedal (includes items 8 through 10)	1
8	1013871	Pad, Accelerator Pedal	1
9	N/A	Accelerator Pedal Weldment	1
10	7716	Screw, #10-16 Type AB, Sheet Metal	4
11	101796201	Spring, Accelerator Return	1
12	<u>101817401</u>	Retainer, Spring	1
13	<u>101861901</u>	Screw, 1/4-20 X 1.125 Hex Cap	4
14	<u>101862001</u>	Screw, 1/4-20 X 1.500 Flange	1
15	<u>102026001</u>	Kit, Accelerator Pivot Rod Assembly (includes items 16 and 17)	1
16	101919801	Spacer, Accelerator	1
17	<u>102158901</u>	Pivot Rod Weldment	1
18	<u>1241</u>	Washer, 5/16 Type A Flat	1
19	<u>1624</u>	Screw, 3/8-16 X 1.50, Hex-Head Cap	1
20	<u>334</u>	Washer, 3/8, Type A, Flat	2
21	<u>7473</u>	Locknut, 5/16-18 Nylon Insert	1
22	<u>8233</u>	Locknut, 1/4-20, Nylon Insert	5
23	<u>8754</u>	Locknut, 3/8-16 Hex	2

5
G
E

5
G
E

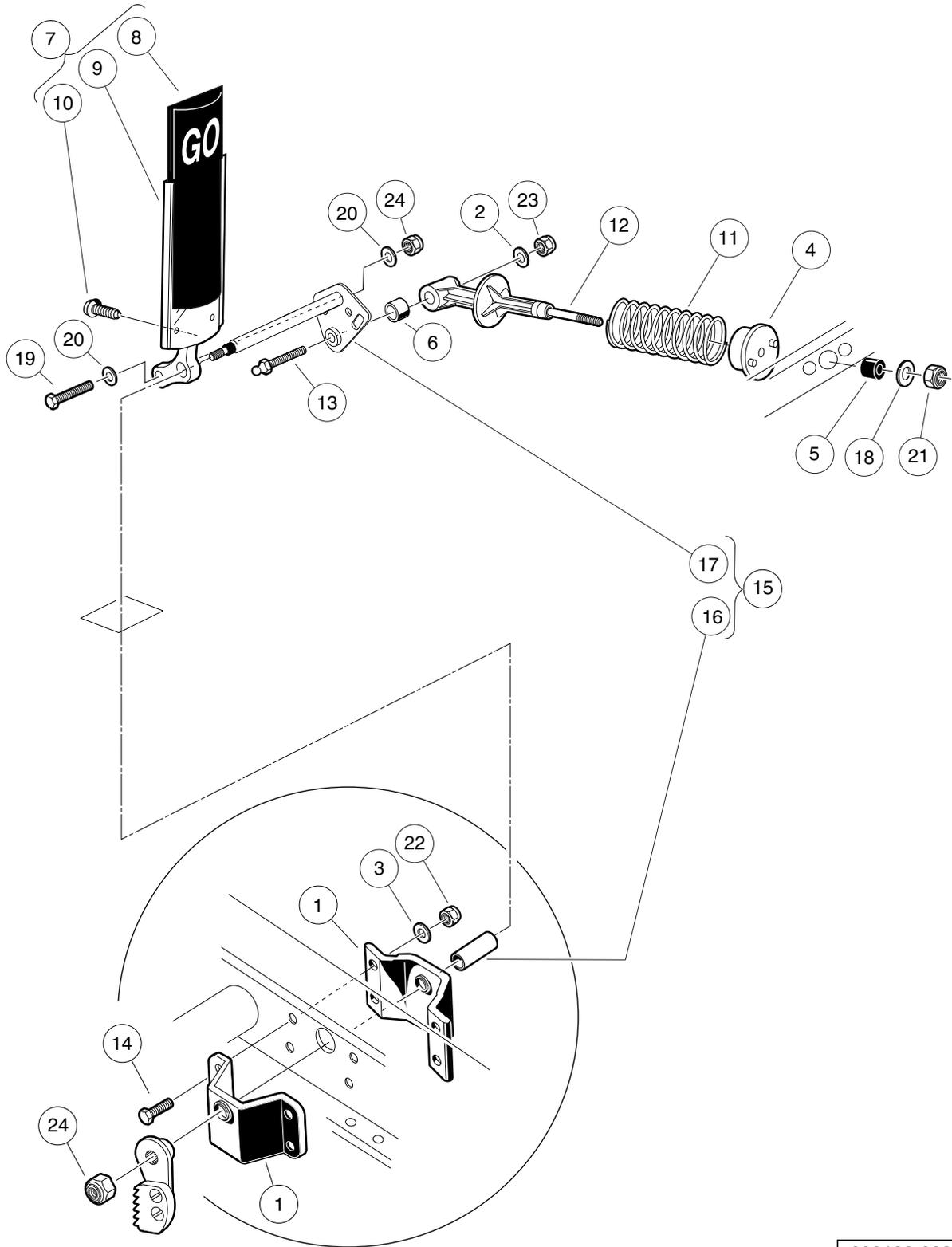

000188-008

ACCELERATOR PEDAL ASSEMBLY – GASOLINE VEHICLES

ITEM	PART NO.	DESCRIPTION	QTY
		1 2 3 4	
1	<u>1011694</u>	Accelerator Bracket and Bearing Assembly	2
2	<u>1011931</u>	Washer, 1/4 Flat	1
3	<u>1014007</u>	Washer, 1/4, Flat	4
4	<u>1017378</u>	Cup, Spring	1
5	<u>1017380</u>	Bumper, Spring Return	1
6	<u>1017424</u>	Bearing, Pivot Support	1
7	<u>1017696</u>	Sub Asm, Accelerator Pedal (includes items 8 through 10)	1
8	1013871	Pad, Accelerator Pedal	1
9	N/A	Accelerator Pedal Weldment	1
10	7716	Screw, #10-16 Type AB, Sheet Metal	4
11	101796201	Spring, Accelerator Return	1
12	<u>101817401</u>	Retainer, Spring	1
13	101818801	Stud, 1/4-28 X 1.35 Ball	1
14	<u>101861901</u>	Screw, 1/4-20 X 1.125 Hex Cap	4
15	<u>102026001</u>	Kit, Accelerator Pivot Rod Assembly (includes items 16 and 17)	1
16	101919801	Spacer, Accelerator	1
17	<u>102158901</u>	Pivot Rod Weldment	1
18	<u>1241</u>	Washer, 5/16 Type A Flat	1
19	<u>1624</u>	Screw, 3/8-16 X 1.50, Hex-Head Cap	1
20	<u>334</u>	Washer, 3/8, Type A, Flat	2
21	<u>7473</u>	Locknut, 5/16-18 Nylon Insert	1
22	<u>8233</u>	Locknut, 1/4-20, Nylon Insert	4
23	<u>8717</u>	Locknut, Nylon Insert, 1/4-28	1
24	<u>8754</u>	Locknut, 3/8-16 Hex	2

5
G
E

5
G
E

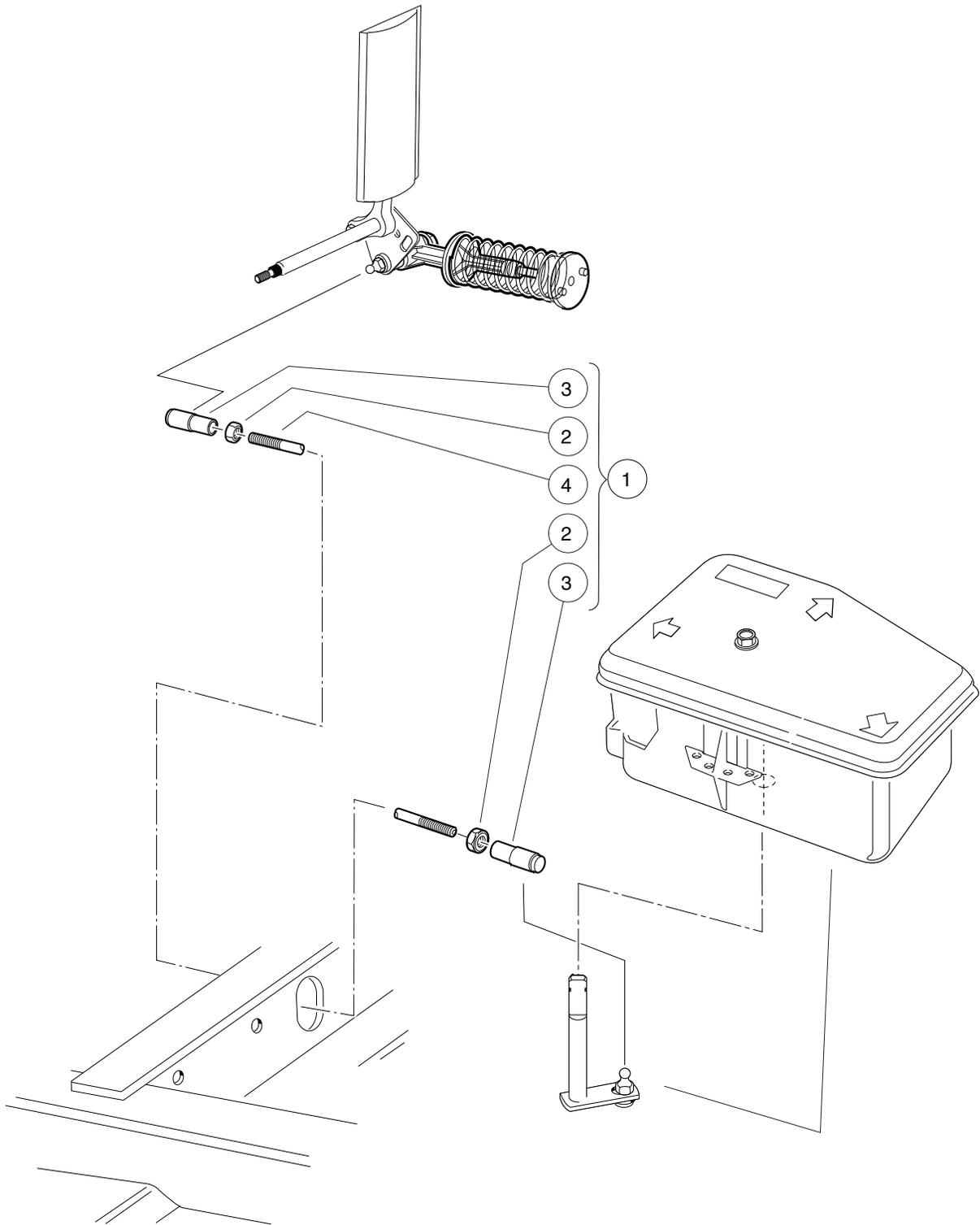

000362-001

ACCELERATOR ROD – GASOLINE VEHICLES

ITEM	PART NO.	DESCRIPTION	QTY
		1 2 3 4	
1	101912401	Rod, Accelerator (includes items 2 through 4)	1
2	<u>1011084</u>	Nut, 1/4-28 Hex Jam	2
3	<u>1011734</u>	Joint, Ball	2
4	N/A	Accelerator Rod	1

5
G
E

5
G
E

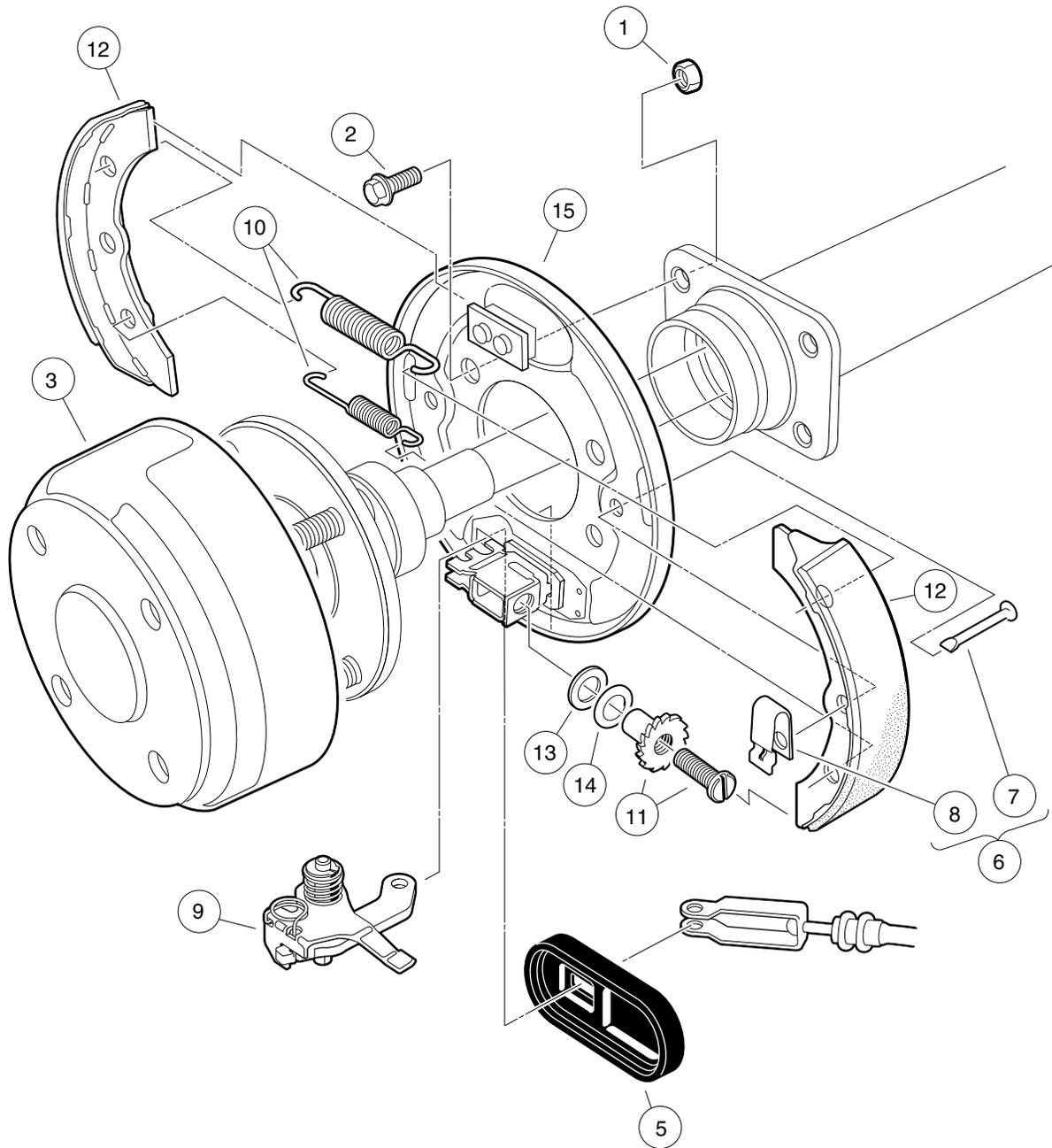

000186-002

REAR BRAKE ASSEMBLY, SELF-ADJUSTING – VEHICLE WITH 2-WHEEL BRAKES

ITEM	PART NO.	DESCRIPTION	QTY
		1 2 3 4	
1	<u>1013924</u>	Nut, 5/16-24, Hex Head Cone	8
2	<u>1014153</u>	Bolt, Brake Cluster Mounting	8
3	<u>101791101</u>	Drum without Center Hole, Brake	2
4	<u>101823301</u>	Cluster Assembly, Right (Passenger) Brake (includes items 5 through 15)	1
5	<u>1010850</u>	Dust Cover	1
6	<u>1011466</u>	Kit, Shoe Retainer (includes items 7 and 8)	1
7	N/A	Pin	2
8	N/A	Shoe Clamp Spring	2
9	101815501	Lever Assembly, Self-Adjusting Brake, Right (Passenger)	1
10	<u>101816301</u>	Package, Brake Spring, Self-Adjusting	1
11	<u>101816501</u>	Adj Mechanism, S.A. Brakes, Right (Passenger)	1
12	<u>101823201</u>	Package, Brake Shoe, Self-Adjusting	1
13	<u>101823801</u>	Plate, Washer, Brake, Self-Adjusting	1
14	<u>101823901</u>	Washer, Brake, Self-Adjusting	1
15	<u>101824001</u>	Plate Assembly, Right Brake Backing	1
16	<u>101823302</u>	Cluster Assembly, Left Brake (includes items 17 through 27)	1
17	<u>1010850</u>	Dust Cover	1
18	<u>1011466</u>	Kit, Shoe Retainer (includes items 19 and 20)	1
19	N/A	Pin	2
20	N/A	Shoe Clamp Spring	2
21	101815502	Lever Assembly, Self-Adjusting Brake, Left	1
22	<u>101816301</u>	Package, Brake Spring, Self-Adjusting	1
23	<u>101816502</u>	Adjusting Mechanism, Self-Adjusting Brake, Left	1
24	<u>101823201</u>	Package, Brake Shoe, Self-Adjusting	1
25	<u>101823801</u>	Plate, Washer, Brake, Self-Adjusting	1
26	<u>101823901</u>	Washer, Brake, Self-Adjusting	1
27	<u>101824002</u>	Plate Assembly, Left Brake Backing	1
Note: Driver-side brake cluster not shown. Components have a similar appearance to passenger-side brake cluster components.			

5
G
E

5
G
E

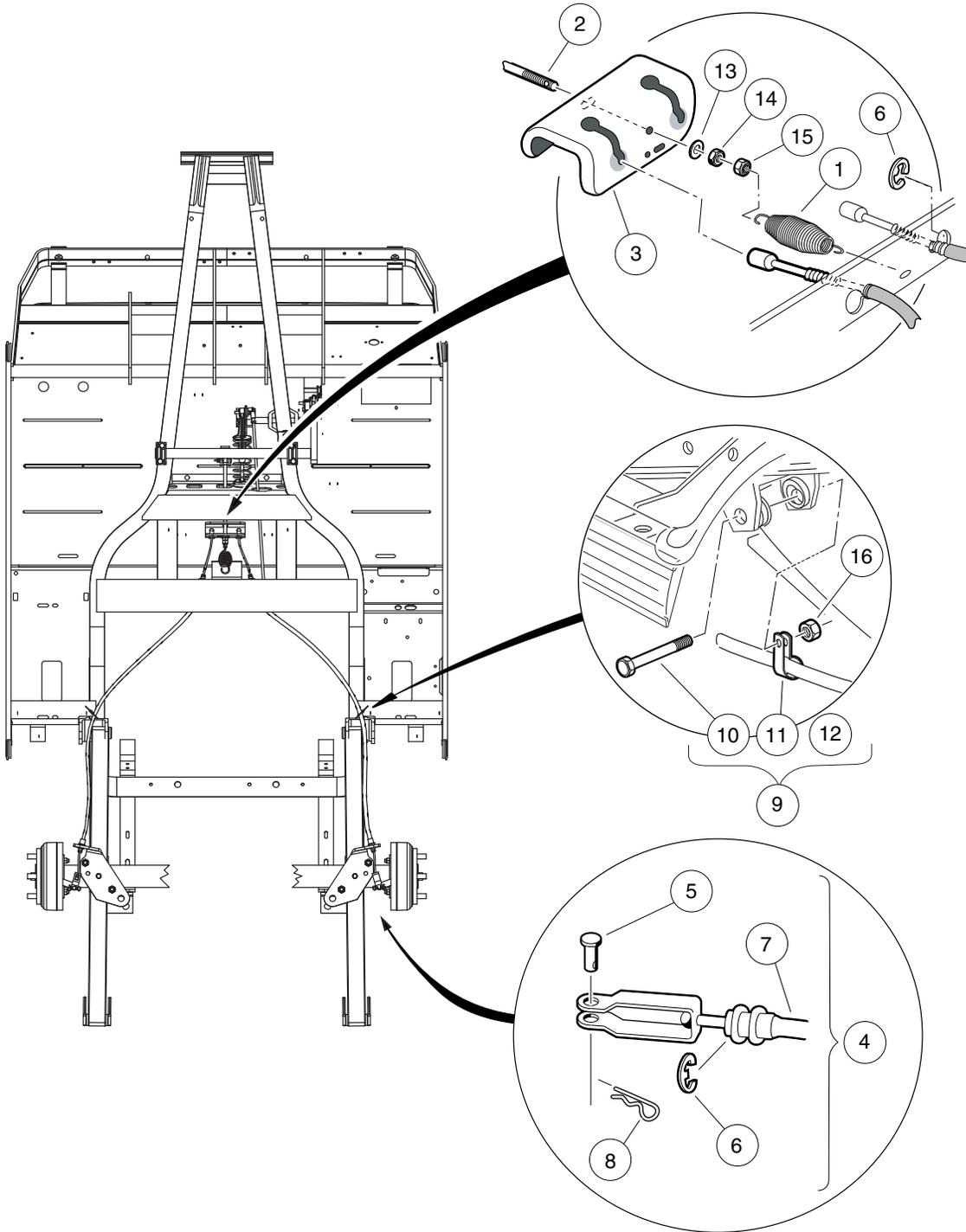

000245-002

BRAKE CABLES AND EQUALIZER

ITEM	PART NO.	DESCRIPTION	QTY
		1 2 3 4	
1	<u>1013531</u>	Spring, Brake Return	1
2	<u>101953101</u>	Rod, Equalizer, 8.91"	1
3	<u>101990801</u>	Equalizer Bracket	1
4	<u>102022101</u>	Brake Cable Kit (includes items 5 through 8)	2
5	<u>1010829</u>	Pin, Clevis, 5/16 X 3/4	1
6	<u>1011779</u>	E-Clip, 1/2	2
7	N/A	Cable, Brake, 41"	1
8	<u>102292801</u>	Pin, Bow Tie Locking - .072	1
9	<u>103377301</u>	Kit, Field P-clamp, Brake Line (includes items 10 through 12)	1
10	<u>102066201</u>	Screw, 3/8-16 X 3.50 Hex Cap	2
11	<u>103377201</u>	P-clamp, Brake Line	2
12	N/A	Instr Fd. P-clamp, Brake Line	1
13	<u>1241</u>	Washer, 5/16 Type A Flat	5
14	<u>1242</u>	Nut, 5/16-18 Hex	1
15	<u>7473</u>	Locknut, 5/16-18 Nylon Insert	5
16	<u>8754</u>	Locknut, 3/8-16 Hex	2

5
G
E

5

G

E

STEERING AND SUSPENSIONS

6

G

E

6
G
E

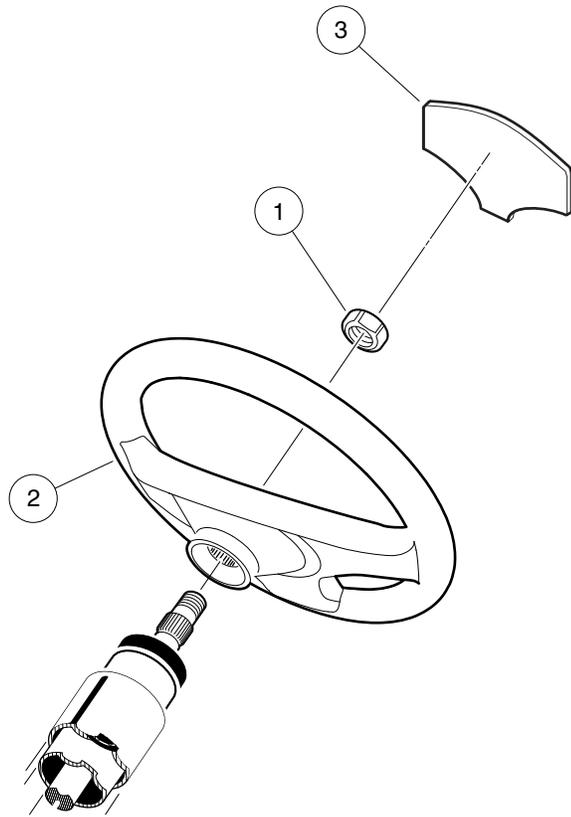

000246-001

STEERING WHEEL

ITEM	PART NO.	DESCRIPTION	QTY
		1 2 3 4	
1	<u>1017273</u>	Nut, 5/8-18 Nylon Insert Jam	1
2	<u>102796201</u>	Steering Wheel, Spline	1
3	<u>102822401</u>	Wheel Center	1

6

G

E

6
G
E

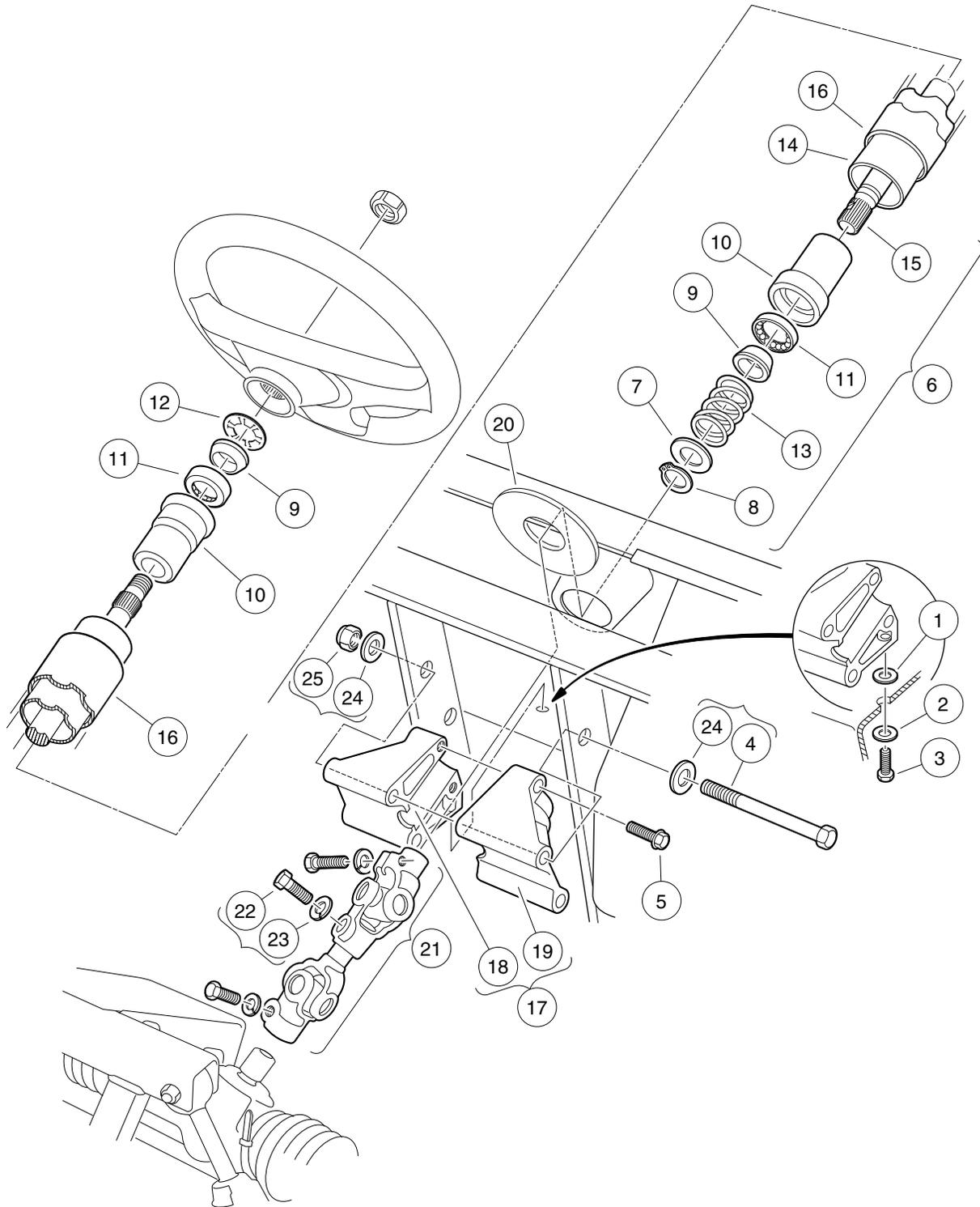

000247-001

STEERING COLUMN

ITEM	PART NO.	DESCRIPTION	QTY
		1 2 3 4	
1	<u>1011578</u>	Washer, 5/16 Type B Flat	1
2	<u>1011697</u>	Washer, 5/16 Flat	1
3	<u>1014288</u>	Screw, 5/16-18 X 0.75, Thread-Forming	1
4	<u>1016183</u>	Screw, 3/8-16 X 7.00 Hex Cap	2
5	<u>1016269</u>	Screw, 5/16-18 Thrd Forming	2
6	<u>1017313</u>	Steering Shaft Assembly (includes items 7 through 15)	1
7	<u>1012604</u>	Washer, 0.675 ID X 1.19 OD	1
8	<u>1012605</u>	Ring, 0.579 Internal Retaining	1
9	1014125	Wedge, Molded	2
10	<u>1014126</u>	Seat, Plastic Bearing	2
11	<u>1014213</u>	Bearing, Ball	2
12	1014214	Ring, Retaining	1
13	<u>1014217</u>	Spring, Steering Shaft	1
14	<u>1017314</u>	Column, Aluminum Steering	1
15	<u>1017315</u>	Shaft Steering Column	1
16	<u>1017317</u>	Tube Cover, Steering Column	1
17	101984801	Kit, Steering Column Mounting Bracket (includes items 18 and 19)	1
18	N/A	Bracket, RH Steering Column Mount	1
19	N/A	Bracket, LH Steering column mount	1
20	<u>102278001</u>	Boot, Steering Column Round	1
21	<u>103601601</u>	Shaft, Intermediate Steering (includes items 22 and 23)	1
22	<u>1017226</u>	Bolt, Hex-Head, 8mm X 1.25 - 30	3
23	<u>7174</u>	Lockwasher, 5/16 Split	3
24	<u>334</u>	Washer, 3/8, Type A, Flat	4
25	<u>8754</u>	Locknut, 3/8-16 Hex	2

6
G
E

6
G
E

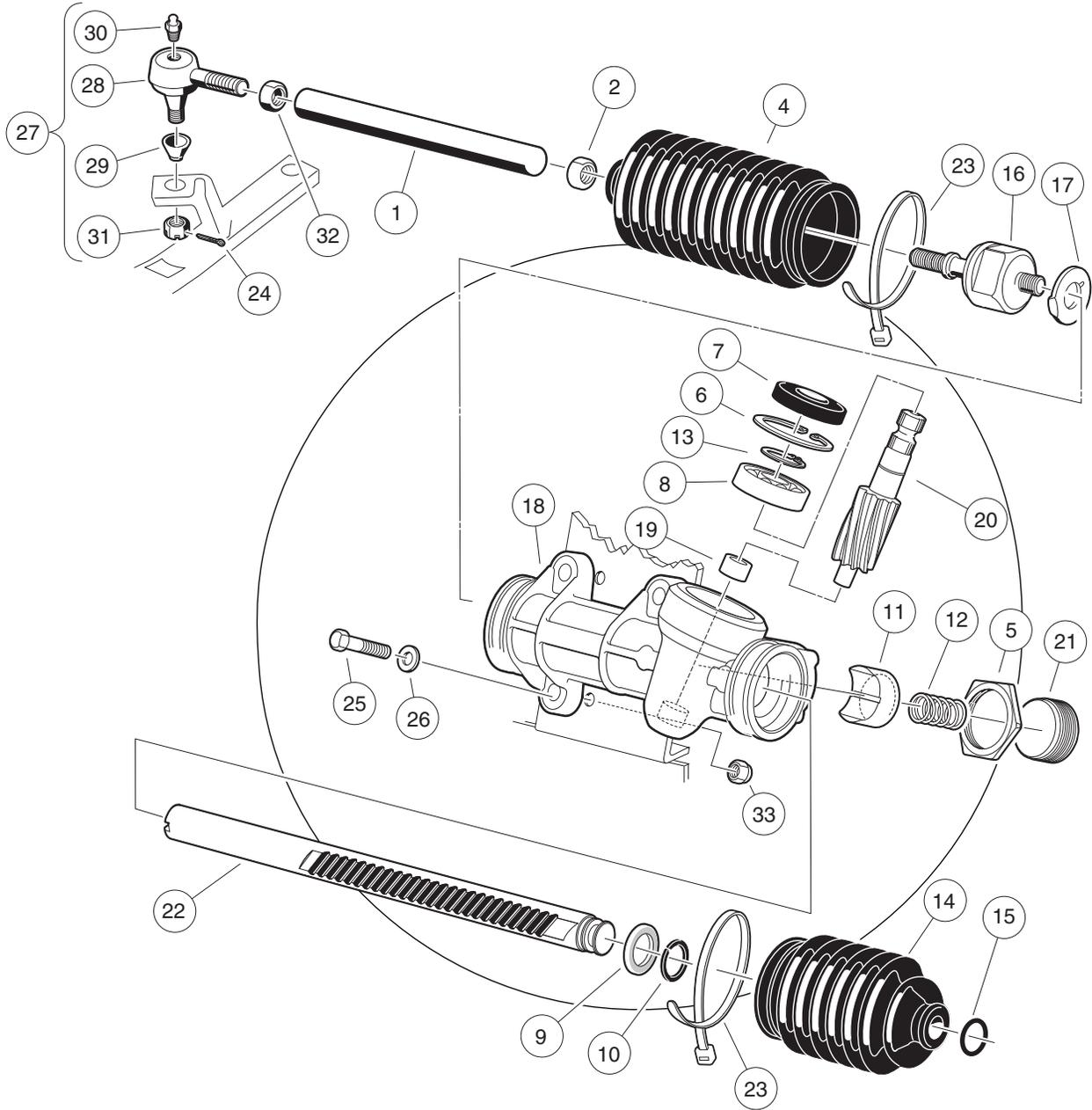

000189-003

STEERING GEAR ASSEMBLY

ITEM	PART NO.	DESCRIPTION	QTY
		1 2 3 4	
1	<u>1012467</u>	Link, Rack and Pinion Drag	1
2	1013042	Nut, 12mm Hex	1
3	<u>101878302</u>	Steering Gear Assembly (without yoke) (includes items 4 through 23)	1
4	<u>1013035</u>	Bellows, Long	1
5	<u>1013044</u>	Rack Screw Locknut	1
6	N/A	Snap Ring	1
7	<u>1013052</u>	Seal, Steering Pinion Dust	1
8	<u>101879401</u>	Bearing, Ball	1
9	<u>101879501</u>	Stop Washer	1
10	101879601	Stop Ring, C-Type	1
11	<u>101879701</u>	Support Yoke	1
12	<u>101879801</u>	Rack Guide Pressure Spring	1
13	<u>101879901</u>	Ring, Stop, C-Type	1
14	<u>101880001</u>	Bellows, Short	1
15	101880101	Dust Seal Retaining Ring	1
16	<u>101880201</u>	Inner Ball Joint Asm	1
17	101880301	Washer, Tab	1
18	N/A	Box, Steering Gear	1
19	N/A	Bearing, Lower Pinion	1
20	N/A	Pinion, Steering	1
21	N/A	Screw, Rack Guide	1
22	N/A	Rack, Steering	1
23	<u>8990</u>	Tie Wrap, 8" Nylon	2
24	<u>1035</u>	Cotter Pin, 3/32 x 1	1
25	<u>1624</u>	Screw, 3/8-16 X 1.50, Hex-Head Cap	3
26	<u>334</u>	Washer, 3/8, Type A, Flat	3
27	<u>7540</u>	Ball Joint, Left (includes items 28 through 31)	1
28	1011895	Socket, LH Vertical	1
29	<u>1011930</u>	Seal, Vertical Socket Dust	1
30	<u>1015597</u>	Fitting, 1/4-28 Thread-Forming Grease	1
31	7602	Nut, 3/8-24 UNF Hex	1
32	<u>7555</u>	Nut, 1/2-20 Hex, Left-Hand Thread	1
33	<u>8754</u>	Locknut, 3/8-16 Hex	3

6
G
E

6
G
E

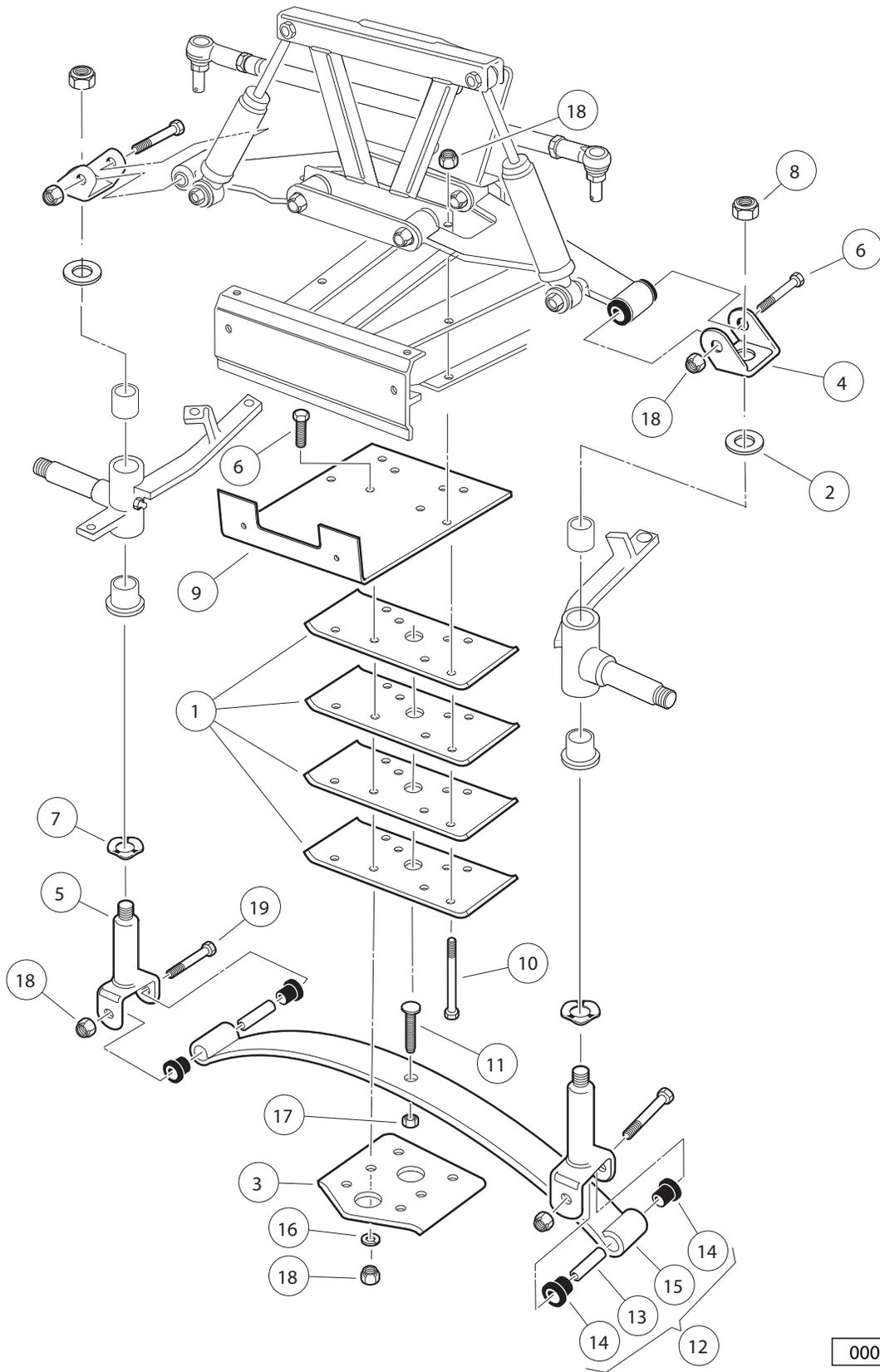

000191-005

FRONT SUSPENSION, LOWER – VEHICLES WITH TWO-WHEEL BRAKES

ITEM	PART NO.	DESCRIPTION	QTY
		1 2 3 4	
1	<u>1010124</u>	Plate, Spring Mount	4
2	<u>1010150</u>	Bearing, Thrust	2
3	<u>1014276</u>	Plate, Front Spring Retainer	1
4	<u>1016384</u>	Clevis, Delta Upper	2
5	<u>1016386</u>	King Pin Assembly	2
6	<u>1016387</u>	Screw, 3/8-16 X 2.75 Hx Hd Cap	6
7	<u>1016389</u>	Washer, 1.125 Od Wave	2
8	<u>101903101</u>	Locknut, 1/2-20 Nylon Insert	2
9	<u>102830401</u>	Support, Brush Guard	1
10	<u>102913601</u>	Screw, 3/8-16 X 5.50 Hx Hd Cap	4
11	<u>103507001</u>	Eccentric Bolt Common	1
12	<u>103628701</u>	Spring Asm, Front, 1 Leaf (includes items 13 through 15)	1
13	<u>1012303</u>	Bushing, Steel	2
14	<u>101558302</u>	Bushing, Urethane, Soft	4
15	103502601	Spring, Front, 1 Leaf	1
16	<u>357</u>	Lockwasher, 3/8 Split	4
17	<u>706</u>	Nut, Hex 3/8-16	1
18	<u>8754</u>	Locknut, 3/8-16 Hex	8
19	<u>8755</u>	Screw, 3/8-16 X 3.375 Hex Cap	2

6
G
E

6
G
E

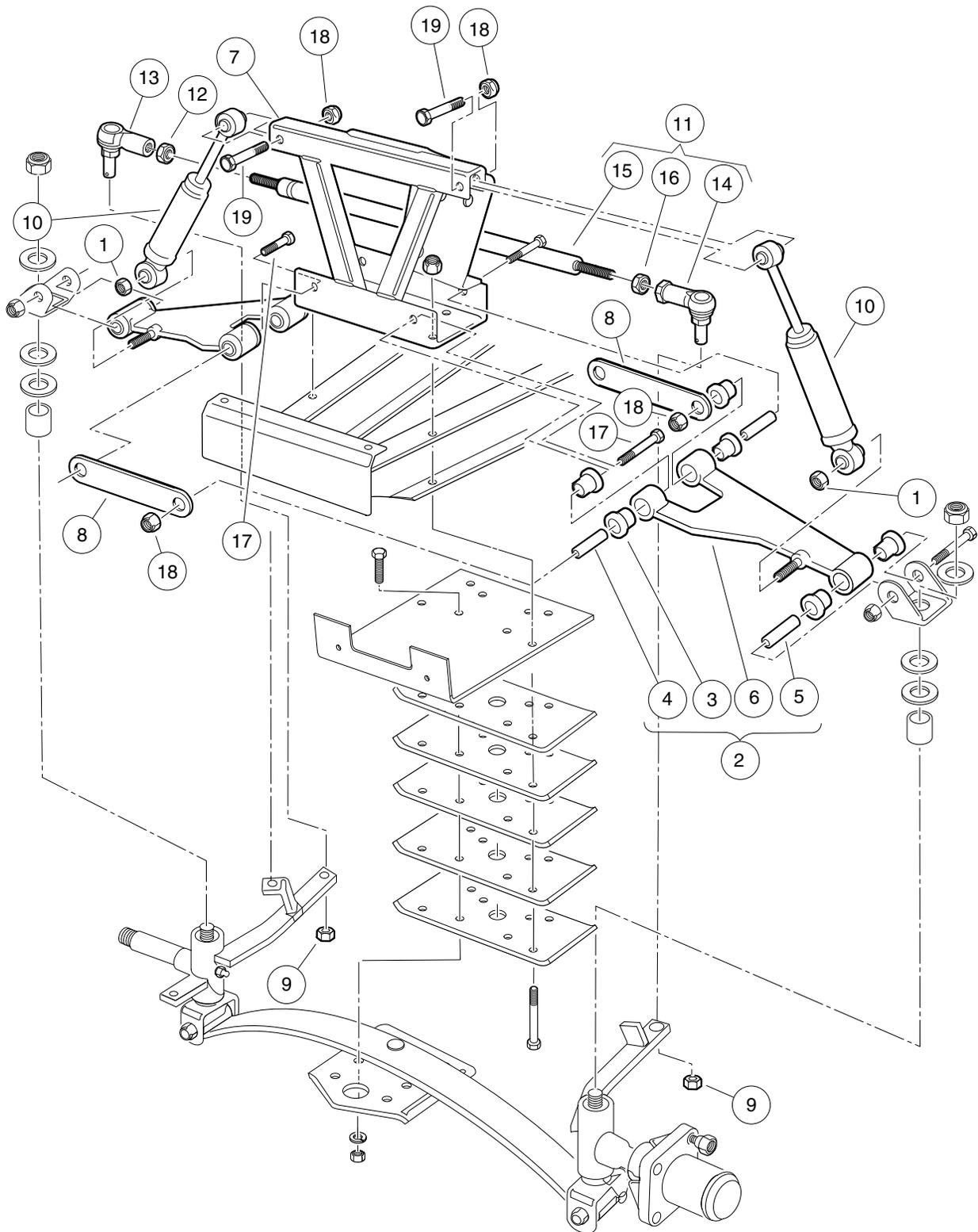

000190-002

FRONT SUSPENSION, UPPER

ITEM	PART NO.	DESCRIPTION	QTY
		1 2 3 4	
1	<u>1010138</u>	Locknut, 3/8-16 Dimpled	2
2	<u>1016353</u>	Sub-Assembly, Delta A-Plate (includes items 3 through 6)	2
3	<u>1016346</u>	Bushing, Urethane	6
4	<u>1016349</u>	Sleeve, Delta Inner	2
5	<u>1016350</u>	Sleeve, Delta Outer	1
6	<u>1016351</u>	Delta A-Plate	1
7	<u>1016385</u>	Delta Shock and Gear Support Assembly	1
8	<u>1017266</u>	A-Plate Strap	2
9	<u>102289201</u>	Nut - Hex Locking, M12 X 1.25	3
10	<u>103351001</u>	Shock Absorber, Front, Common	2
11	<u>103653601</u>	Asm, Tie Rod (includes items 12 through 16)	1
12	<u>1013042</u>	Nut, 12mm Hex	1
13	<u>102022601</u>	End, Tie Rod M12 X 1.25 Rh	1
14	<u>102022602</u>	End, Tie Rod, M12 X 1.25, Lh	1
15	<u>103354701</u>	Rod, Tie, Male Thd	1
16	<u>103653501</u>	Nut, Jam, M12-1.25, Lh	1
17	<u>2402</u>	Screw, 3/8-16 X 2.25 Hx Hd Cap	4
18	<u>8754</u>	Locknut, 3/8-16 Hex	13
19	<u>8861</u>	Bolt, 3/8-16 X 1.75 Hex	2

6
G
E

6
G
E

DRIVER SIDE

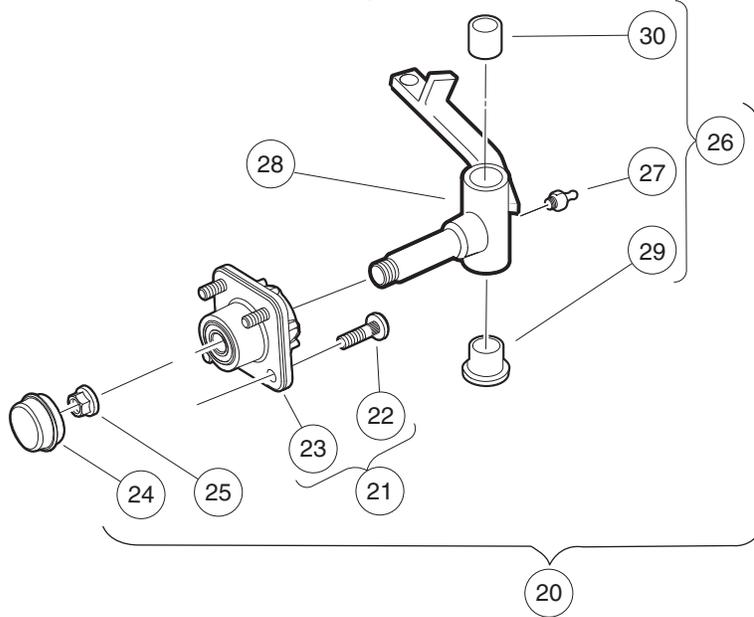

PASSENGER SIDE

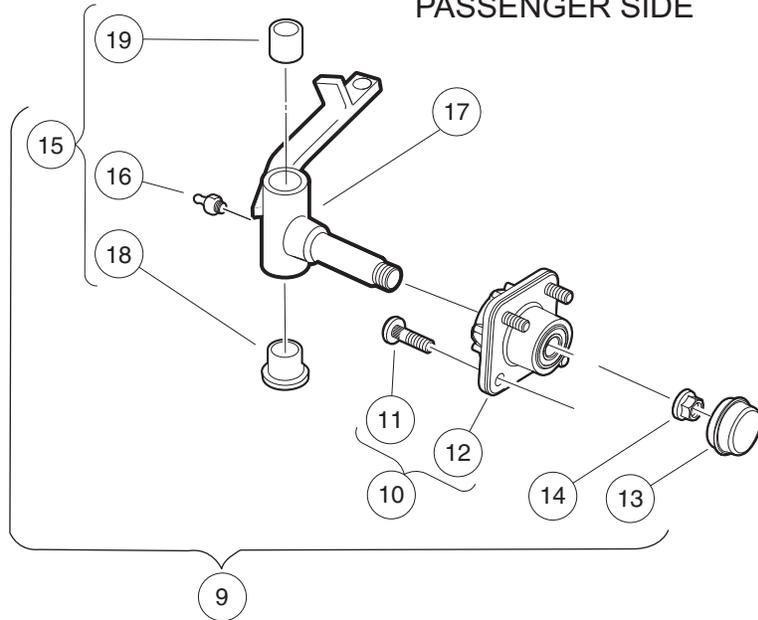

REPLACEMENT HUB
FOR DRIVER OR
PASSENGER SIDE

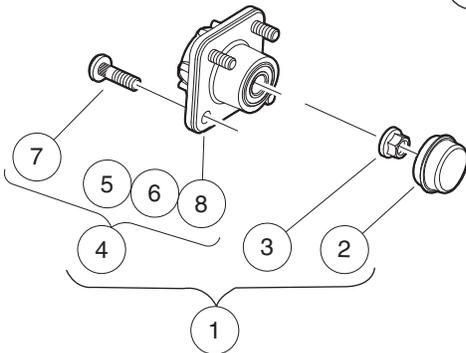

000301-008

FRONT SPINDLES AND HUBS

ITEM	PART NO.	DESCRIPTION	QTY
		1 2 3 4	
1	<u>102357701</u>	Replacement Kit, Front Hub (includes items 2 through 4)	1
2	<u>102353201</u>	Cap, Front Hub	1
3	<u>102353301</u>	Hex Nut, Locking Flange, M14x2	1
4	N/A	Asm, Front Hub, Bb, Long Stud (includes items 5 through 8)	1
5	N/A	Bearing, Ball, 6204	2
6	N/A	Spacer, Bearing, Front Hub, Pm	1
7	<u>103477901</u>	Lug Stud, 1/2-20 Unf, 4037	4
8	N/A	Front Hub, Ball Brg, Long Stud	1
9	N/A	Asm, Hub And Spindle, Left-Hand Ext (includes items 10 through 15)	1
10	N/A	Front Hub Assembly, Ball Bearing (includes items 11 and 12)	1
11	<u>102353401</u>	Lug Stud, 1/2-20 UNF, 4037 Stl	4
12	N/A	Hub, Front	1
13	<u>102353201</u>	Cap, Front Hub	1
14	<u>102353301</u>	Hex Nut, Locking Flange, M14x2	1
15	<u>102354204</u>	Asm, Spindle, LH, Ext (includes items 16 through 19)	1
16	<u>1015597</u>	Fitting, 1/4-28 Thread-Forming Grease	1
17	N/A	Subasm, Spindle, LH, Ext	1
18	<u>7048</u>	Bushing, Flanged Bronze	1
19	<u>8067</u>	Bushing, Bronze Spindle	1
20	N/A	Asm, Hub And Spindle, Right-Hand Ext (includes items 21 through 26)	1
21	N/A	Front Hub Assembly, Ball Bearing (includes items 22 and 23)	1
22	<u>102353401</u>	Lug Stud, 1/2-20 UNF, 4037 Stl	4
23	N/A	Hub, Front	1
24	<u>102353201</u>	Cap, Front Hub	1
25	<u>102353301</u>	Hex Nut, Locking Flange, M14x2	1
26	<u>102354104</u>	Asm, Spindle, RH, Ext (includes items 27 through 30)	1
27	<u>1015597</u>	Fitting, 1/4-28 Thread-Forming Grease	1
28	N/A	Subasm, Spindle, RH, Ext	1
29	<u>7048</u>	Bushing, Flanged Bronze	1
30	<u>8067</u>	Bushing, Bronze Spindle	1

6
G
E

REAR SUSPENSION

ITEM	PART NO.	DESCRIPTION	QTY
		1 2 3 4	
1	<u>1010145</u>	Nut, 3/8-24 Hex	4
2	<u>1011415</u>	Kit, Shock Absorber Cushion (includes items 3 and 4)	4
3	N/A	Cushion, Shock Absorber	2
4	N/A	Retainer, Shock Absorber Cushion	2
5	<u>1012303</u>	Bushing, Steel	6
6	<u>1012304</u>	Shackle, Rear Spring	4
7	<u>1013164</u>	Shock Absorber Kit (includes items 8 through 10)	1
8	N/A	Cushion, Shock Absorber	8
9	N/A	Retainer, Shock Absorber Cushion	8
10	<u>102588501</u>	Shock Absorber, Rear	2
11	<u>101454902</u>	Bumper Mount, Angled	2
12	<u>1014555</u>	Locknut, 7/16-14 Nylon Hex	4
13	1014573	Spring Retainer	2
14	<u>1014675</u>	Rear Leaf Spring	2
15	<u>1014901</u>	Spacer, Overload Bumper	2
16	<u>1014902</u>	U-Bolt	2
17	<u>1015583</u>	Bushing, Urethane	12
18	<u>1017235</u>	Bumper, Jounce	2
19	<u>101926501</u>	Bracket, Left-Hand	1
20	101929401	Bracket, Right	1
21	<u>8754</u>	Locknut, 3/8-16 Hex	6
22	<u>8755</u>	Screw, 3/8-16 X 3.375 Hex Cap	6

6
G
E

6

G

E

ELECTRICAL SYSTEM – GASOLINE VEHICLES

7

G

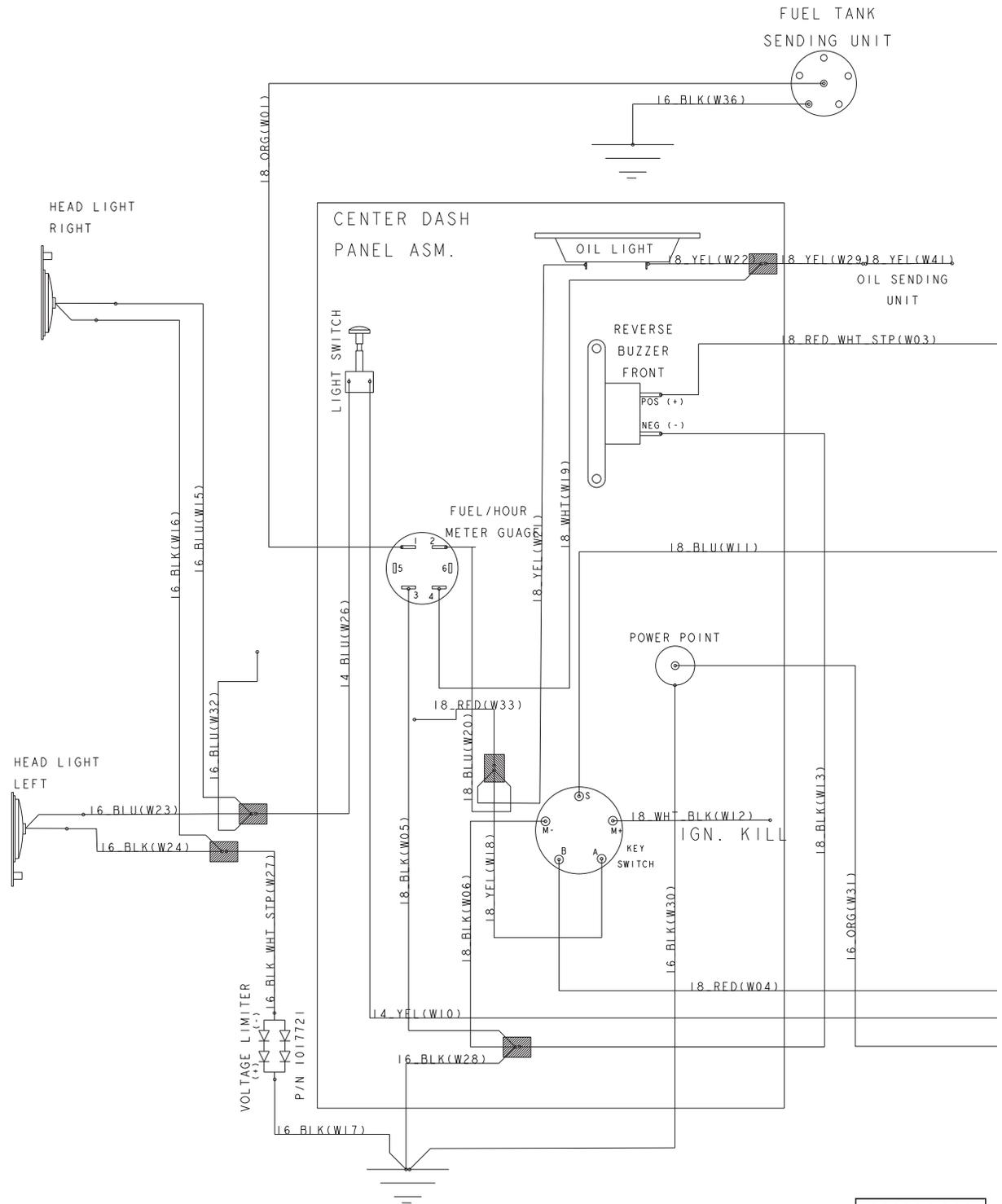

000234-001

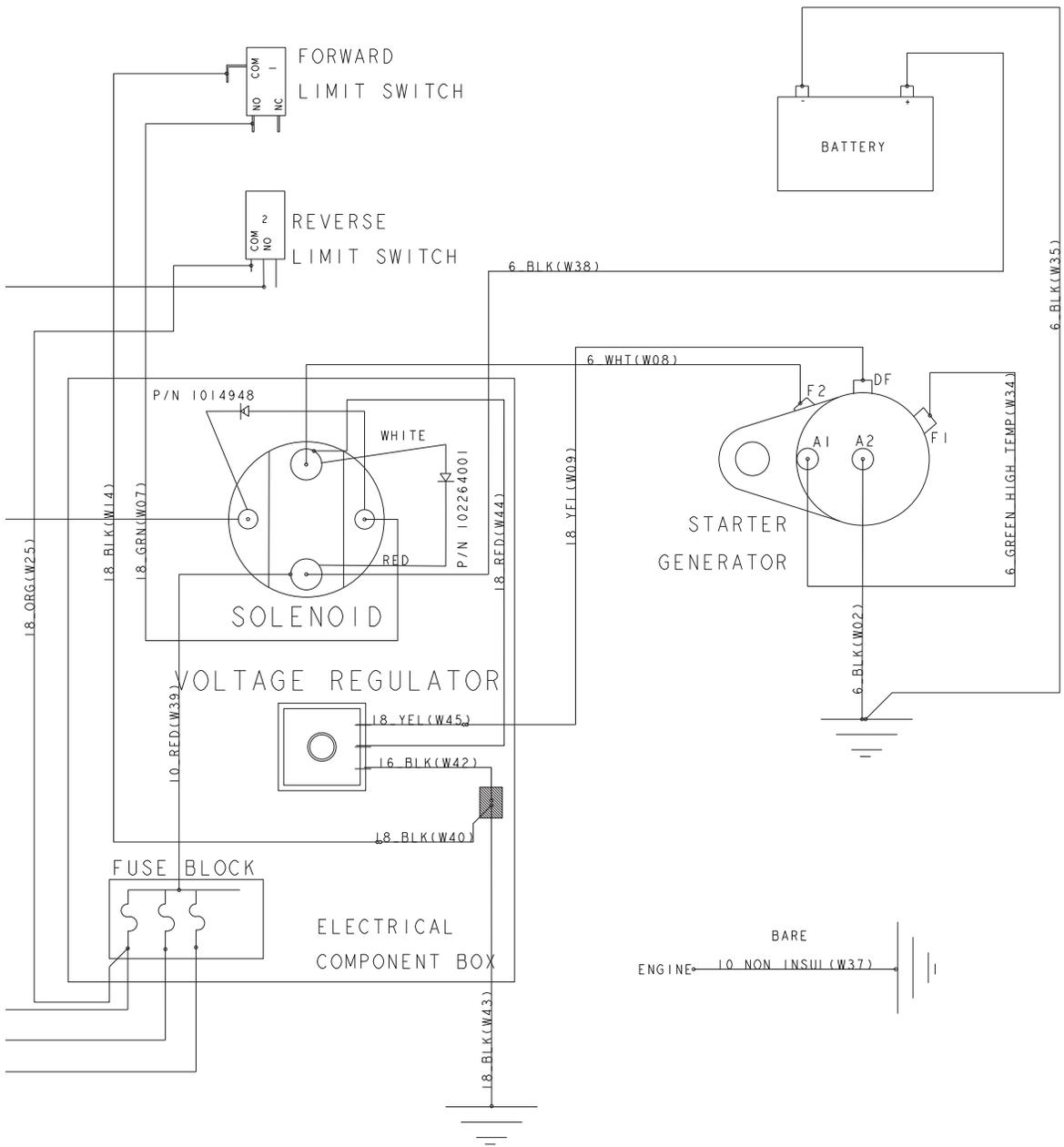

000234-001

7

G

See previous two pages for illustration.

WIRING – GASOLINE VEHICLE

ITEM	PART NO.	DESCRIPTION	QTY
1	<u>102803001</u>	1 2 3 4 Wire Harness, Gasoline Vehicle	1

7

G

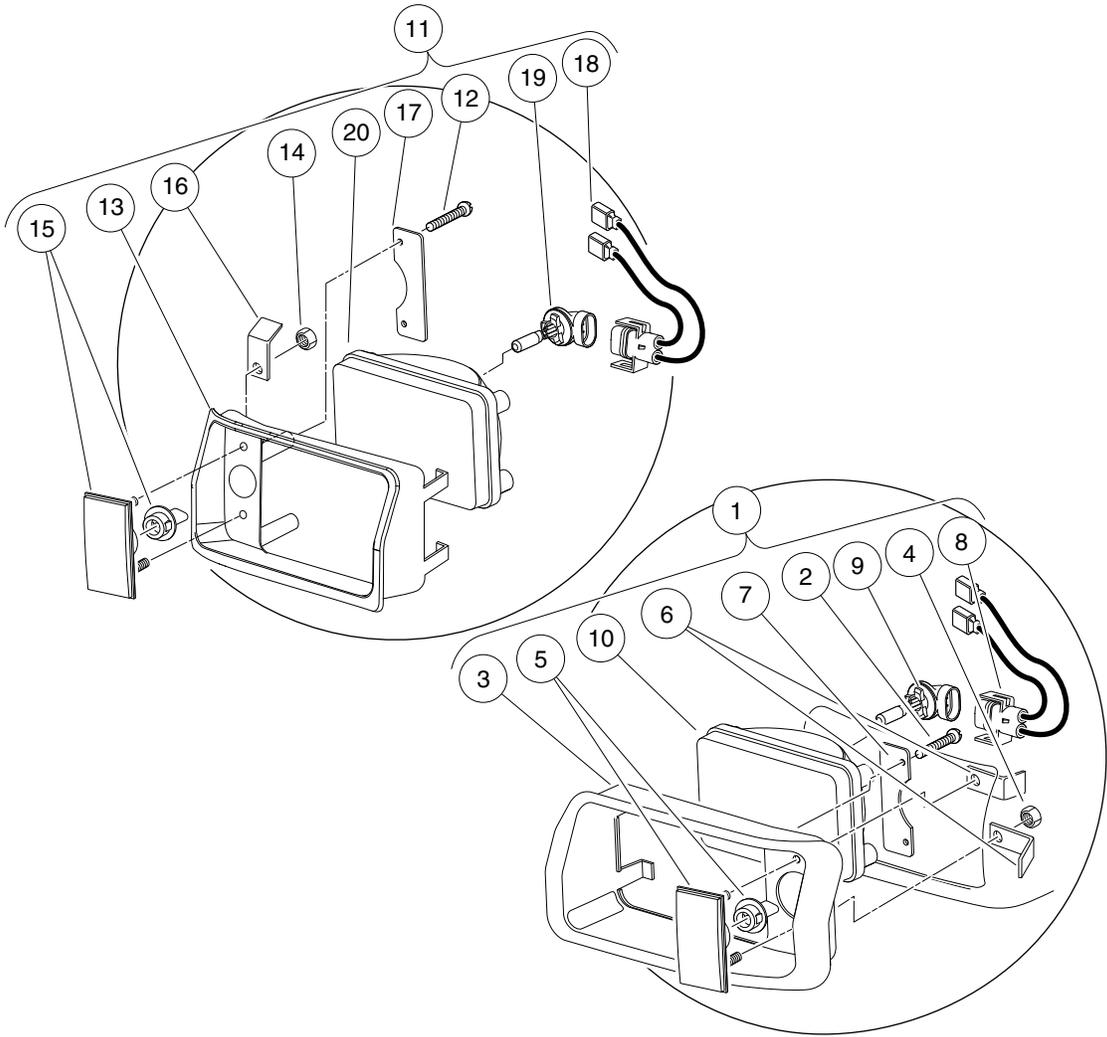

000073-001

HEADLIGHTS

7
G

ITEM	PART NO.	DESCRIPTION	QTY
		1 2 3 4	
1	<u>101988001</u>	Headlight Assembly, Driver-Side Single Beam (includes items 2 through 10)	1
2	<u>1013461</u>	Screw, #10-16 Hex-Head Hi-Lo	2
3	<u>1016880</u>	Headlight Bezel, Left	1
4	<u>1017</u>	Nut, #10-24 Stainless-Steel Hex Machine	2
5	<u>1017062</u>	Turn Signal Lens Assy	1
6	<u>1017064</u>	Mounting Bracket	2
7	<u>1017065</u>	Retainer, Headlight	1
8	<u>101987901</u>	Connector, Harness Assembly, Headlight	1
9	<u>101988101</u>	Bulb, Headlight	1
10	<u>101988201</u>	Lens, Headlight	1
11	<u>101988002</u>	Headlight Assy, Passenger-Side Single Beam (includes items 12 through 20)	1
12	<u>1013461</u>	Screw, #10-16 Hex-Head Hi-Lo	2
13	<u>1016879</u>	Headlight Bezel, Right	1
14	<u>1017</u>	Nut, #10-24 Stainless-Steel Hex Machine	2
15	<u>1017062</u>	Turn Signal Lens Assy	1
16	<u>1017064</u>	Mounting Bracket	2
17	<u>1017065</u>	Retainer, Headlight	1
18	<u>101987901</u>	Connector, Harness Assembly, Headlight	1
19	<u>101988101</u>	Bulb, Headlight	1
20	<u>101988201</u>	Lens, Headlight	1

7
G

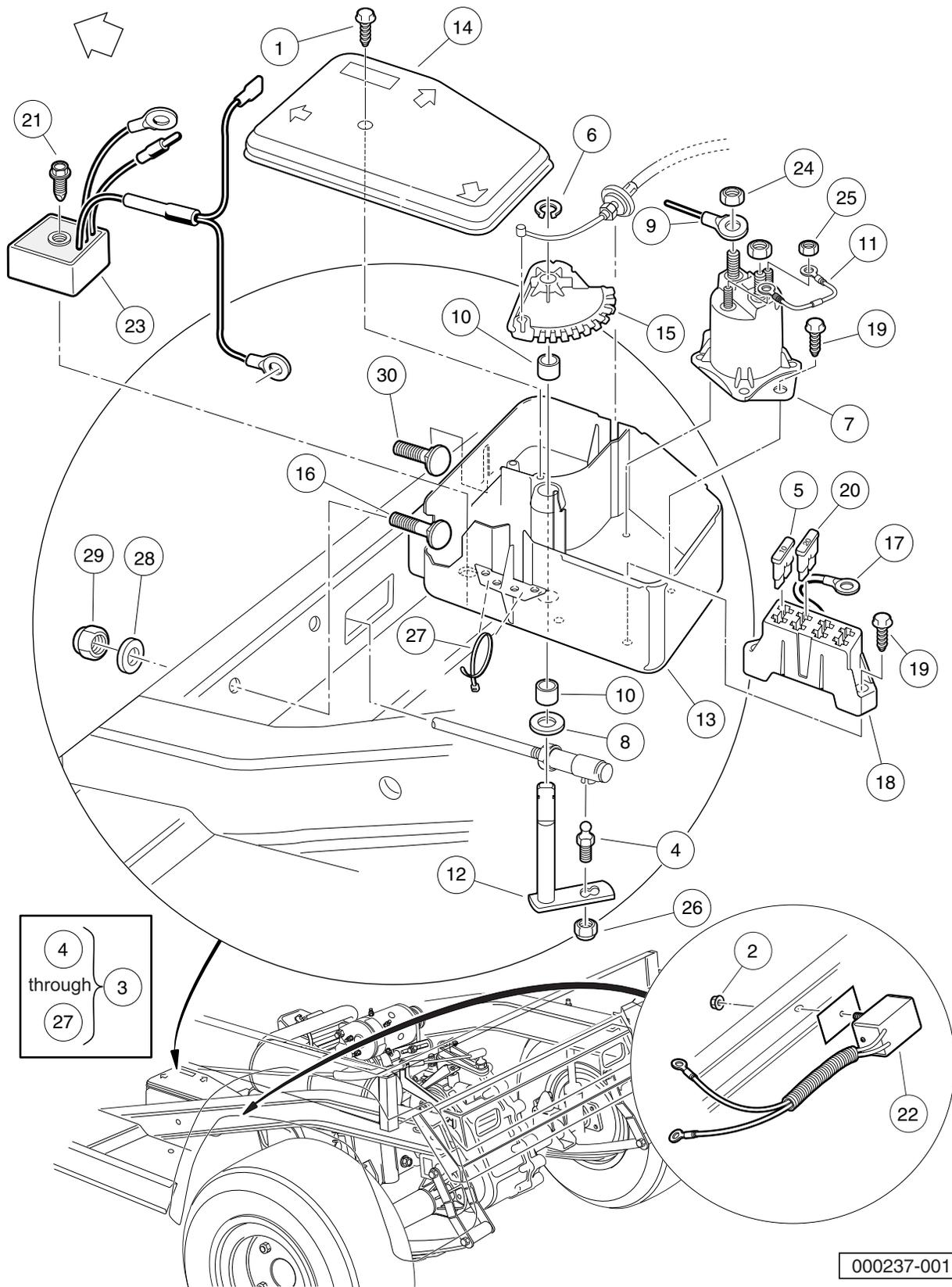

000237-001

ELECTRICAL COMPONENT BOX – GASOLINE VEHICLE

ITEM	PART NO.	DESCRIPTION	QTY
		1 2 3 4	
1	<u>1015752</u>	Screw, #12-16 X 0.625, Hi-Lo	1
2	<u>101963401</u>	Locknut, 5/16-18 Hex Flange	1
3	N/A	Assembly, Electrical Component Box (includes items 4 through 27)	1
4	<u>1010954</u>	Stud, Ball, 1/4-28 X 0.560	1
5	<u>1012295</u>	Fuse, 10-Amp	1
6	<u>1013589</u>	Ring, Retaining, 0.338" Internal	1
7	<u>1013609</u>	Solenoid, 12-Volt	1
8	<u>1014065</u>	Washer, Flat, 0.38" ID, Delrin	1
9	<u>1014119</u>	Wire Assembly #6 Red	1
10	<u>1014145</u>	Bushing, Secondary Weight, Split	2
11	1014948	Diode	1
12	1015345	Bell Crank and Shaft Assembly	1
13	<u>1015371</u>	Box, Electrical Component	1
14	<u>1015372</u>	Cover, Electric Box	1
15	<u>1015373</u>	Cam, Electric Box	1
16	<u>1015405</u>	Bolt, Carriage, 5/16-18 X 2.0	1
17	<u>1015737</u>	Wire Assy, #10 Red	1
18	<u>1015741</u>	Fuse Block	1
19	<u>1015752</u>	Screw, #12-16 X 0.625, Hi-Lo	4
20	<u>1016423</u>	Fuse, 20-Amp	1
21	<u>101856102</u>	Screw, 1/4-15 X 1.50, Hi-lo, Hex	1
22	102264001	Diode Assembly	1
23	<u>102711201</u>	Voltage Regulator	1
24	<u>1242</u>	Nut, 5/16-18 Hex	2
25	<u>7893</u>	Nut, #10-32 Hex	2
26	<u>8717</u>	Locknut, Nylon Insert, 1/4-28	1
27	<u>8990</u>	Tie Wrap, 8" Nylon	2
28	<u>1241</u>	Washer, 5/16 Type A Flat	2
29	<u>7473</u>	Locknut, 5/16-18 Nylon Insert	2
30	<u>7818</u>	Bolt, Carriage, 5/16-18 X 1.5	1

7
G

7
G

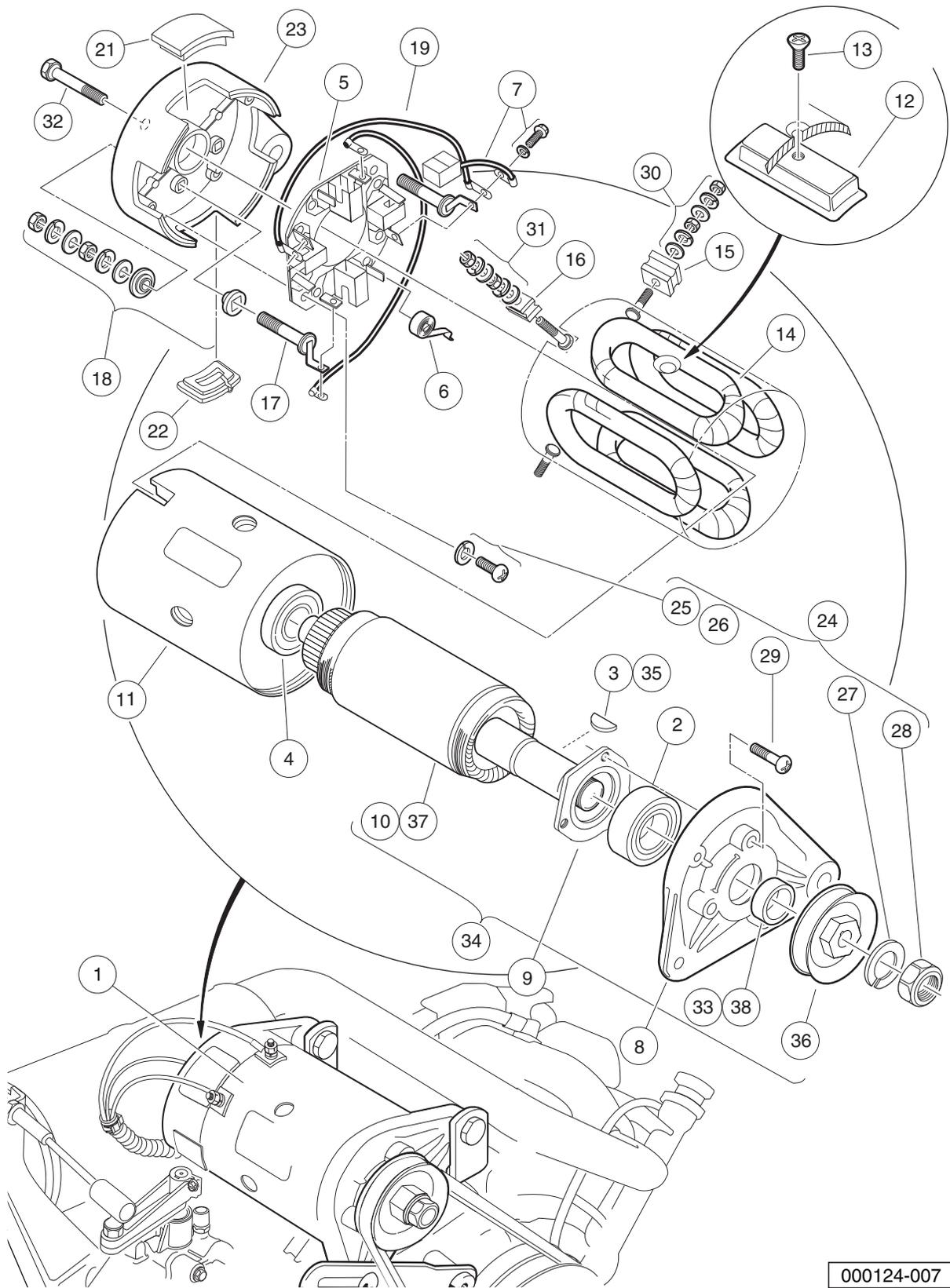

000124-007

STARTER/GENERATOR ASSEMBLY MODEL- G425419 – GASOLINE-VEHICLES

7
G

ITEM	PART NO.	DESCRIPTION	QTY
		1 2 3 4	
1	<u>101833701</u>	Starter/Generator (cw) (includes items 2 through 33)	1
2	<u>1013001</u>	Bearing, Output Shaft Ball	1
3	<u>1013003</u>	Key, Starter/Generator	1
4	<u>1013005</u>	Bearing, Ball	1
5	<u>101301102</u>	Brush Holder Assembly (cw) (includes item 6)	1
6	<u>101878101</u>	Brush Spring Set	4
7	<u>101869302</u>	Brush and Screw Set (cw)	1
8	<u>101874901</u>	Front Bracket	1
9	<u>101875001</u>	Retainer	1
10	<u>101875101</u>	Armature	1
11	<u>101875201</u>	Field Coil Housing	1
12	<u>101875301</u>	Pole Set	1
13	<u>101875401</u>	Screw Set	1
14	<u>101875501</u>	Field Stator Coil Assembly	1
15	<u>101875601</u>	F Insulator Set	2
16	<u>101875701</u>	DF Insulator	1
17	<u>101875802</u>	A Connector (cw)	1
18	<u>101876001</u>	Screw and Mold Assembly	2
19	<u>101876202</u>	Brush Connector Assembly (cw)	2
20	<u>101876301</u>	Cover Set (includes items 21 and 22)	1
21	N/A	Brush Inspection Port Cover	3
22	<u>1017653</u>	Brush Port Cover w/Drain	1
23	<u>101876402</u>	End Bell, Commutator, Rear Bracket (cw)	1
24	<u>101876501</u>	Nut and Screw Set (includes items 25 through 29)	1
25	<u>101896501</u>	Brush Holder Asm Screw	2
26	N/A	Washer, M5 Flat	1
27	N/A	Washer, M14 Lock	1
28	N/A	Nut, Hex, M14 x 2	1
29	N/A	Screw, M5 x 0.8 x 18mm	3
30	<u>101877601</u>	Nut and Washer Set	2
31	<u>101877701</u>	Nut and Washer Set	1
32	<u>101879001</u>	Through Bolt Set	2
33	<u>101939901</u>	Spacer	1
34	<u>101875102</u>	Armature Asm Conversion Kit (includes items 35 through 38)	1
35	<u>1013003</u>	Key, Starter/Generator	1
36	<u>1014289</u>	Pulley, Starter/Generator	1
37	<u>101875101</u>	Armature	1
38	<u>101939901</u>	Spacer	1
		Note: Item 36 will ONLY fit Model G425419 Starter/Generator.	

7
G

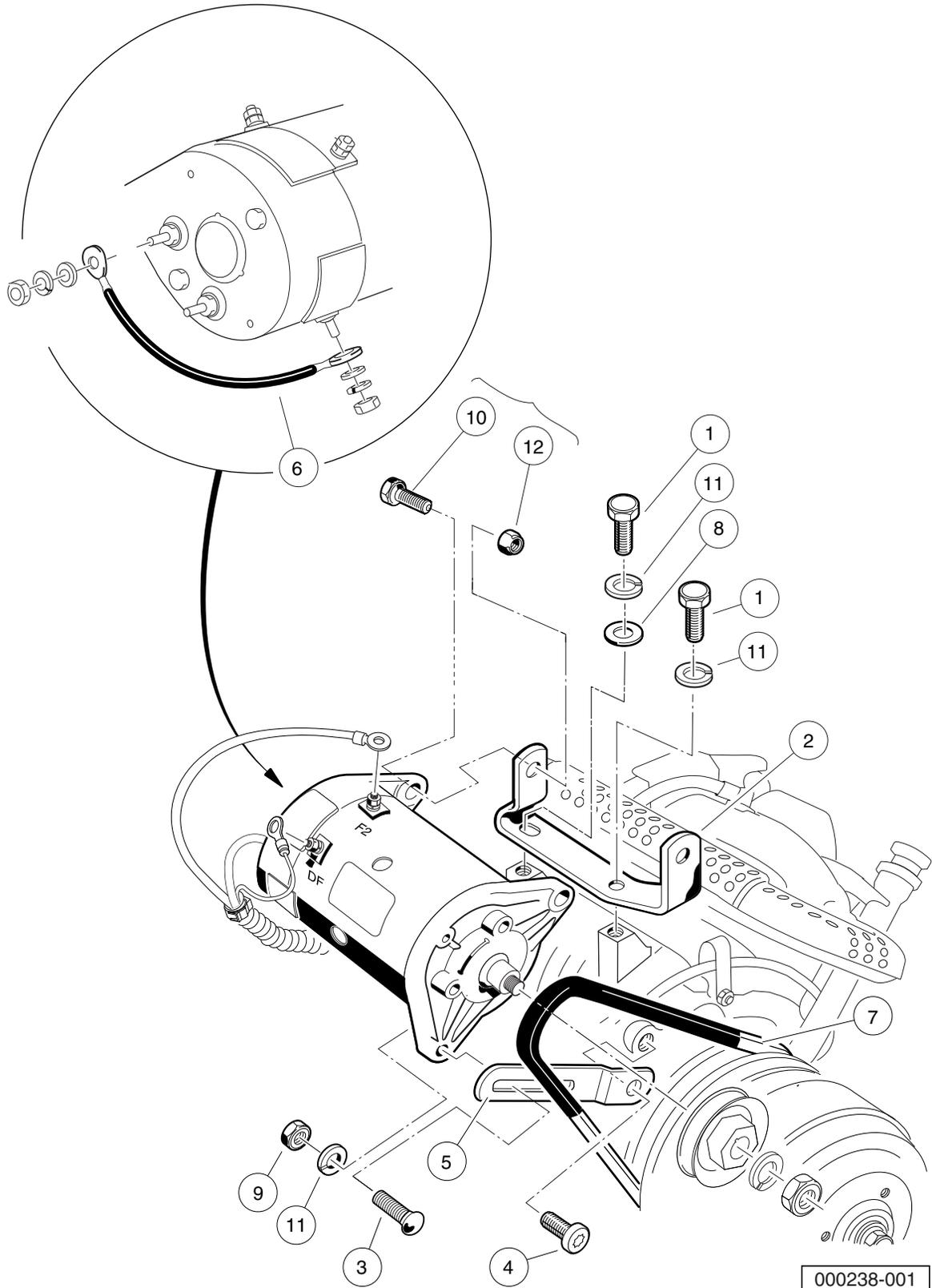

000238-001

FE290 STARTER/GENERATOR MOUNTING – GASOLINE VEHICLE

ITEM	PART NO.	DESCRIPTION	QTY
		1 2 3 4	
1	<u>1012830</u>	Screw, M8-1.25 X 22 Hex-Head	2
2	<u>101524001</u>	Bracket, Starter/Generator Mounting (FE290)	1
3	<u>1015932</u>	Bolt, Carriage, 5/16-18	1
4	<u>1016074</u>	Screw, M8-1.25 X 18mm Torx	1
5	<u>1016883</u>	Bracket, Starter/Generator Adjustment	1
6	<u>101837301</u>	Wire Assy, #6 Green	1
7	<u>101916701</u>	V-Belt	1
8	<u>1241</u>	Washer, 5/16 Type A Flat	1
9	<u>1242</u>	Nut, 5/16-18 Hex	1
10	705	Screw, Cap-hex Hd 3/8-16x1.25	2
11	<u>7174</u>	Lockwasher, 5/16 Split	3
12	<u>8754</u>	Locknut, 3/8-16 Hex	2

7
G

7
G

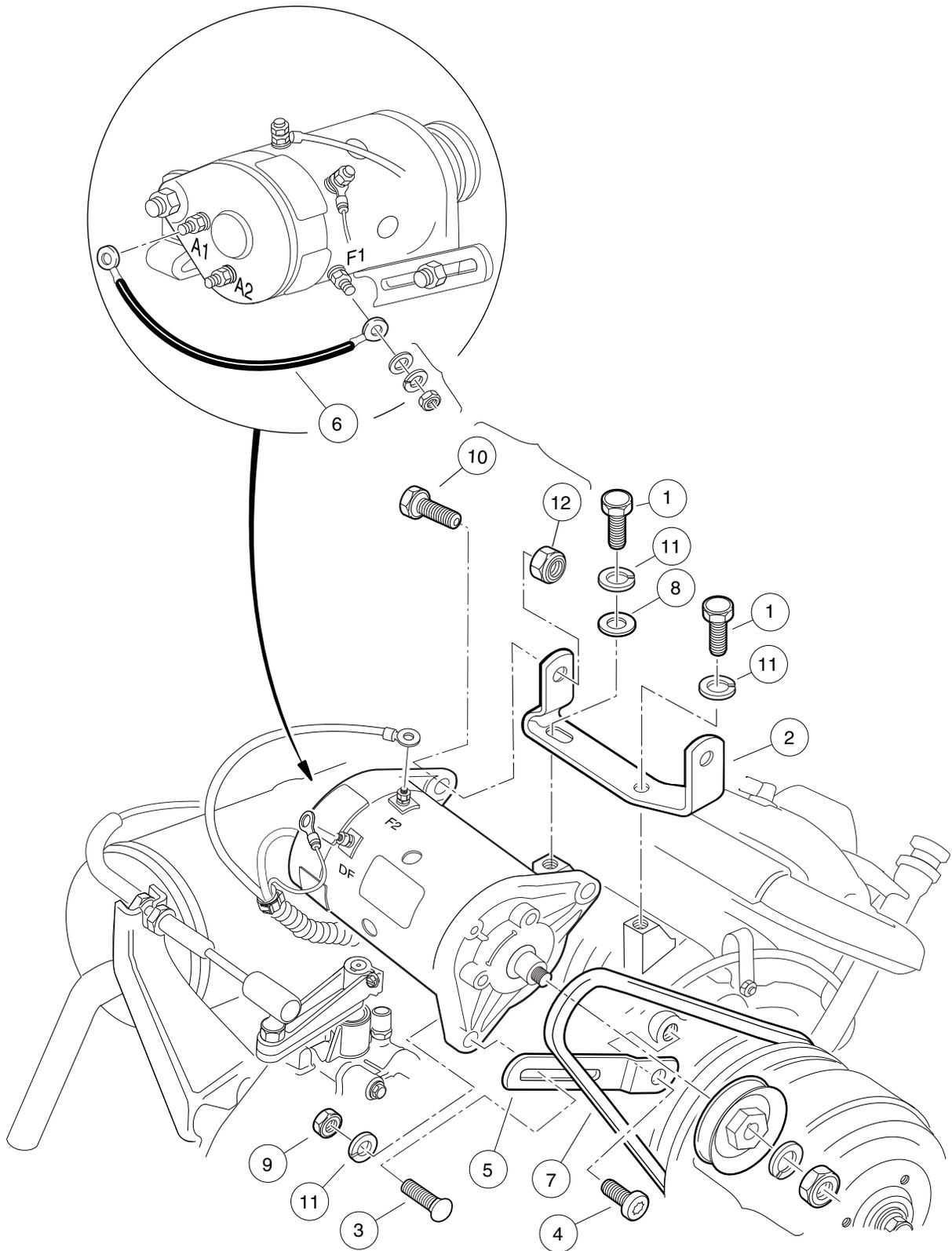

000239-001

FE350 STARTER/GENERATOR MOUNTING – GASOLINE VEHICLES

ITEM	PART NO.	DESCRIPTION	QTY
		1 2 3 4	
1	<u>1012830</u>	Screw, M8-125 X 22 Hex-Head	2
2	<u>101524002</u>	Bracket, Starter/Generator Mounting	1
3	<u>1015932</u>	Bolt, Carriage, 5/16-18	1
4	<u>1016074</u>	Screw, M8-1.25 X 18mm Torx	1
5	<u>1016883</u>	Bracket, Starter/Generator Adjustment	1
6	<u>101837301</u>	Wire Assy, #6 Green	1
7	<u>101916701</u>	V-Belt	1
8	<u>1241</u>	Washer, 5/16 Type A Flat	1
9	<u>1242</u>	Nut, 5/16-18 Hex	1
10	705	Screw, Cap-hex Hd 3/8-16x1.25	2
11	<u>7174</u>	Lockwasher, 5/16 Split	3
12	<u>8754</u>	Locknut, 3/8-16 Hex	2

7
G

7
G

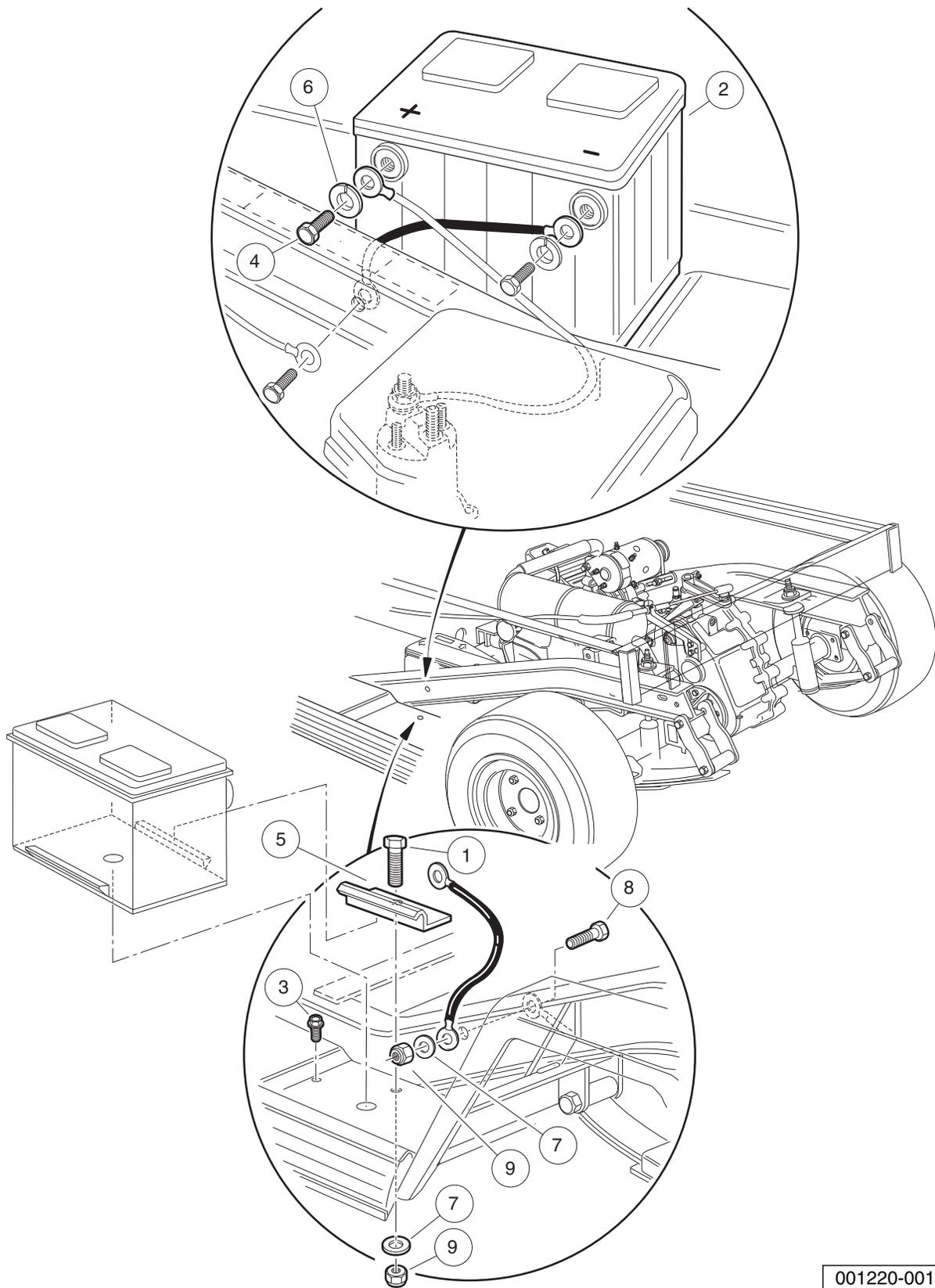

001220-001

BATTERY – GASOLINE UTILITY VEHICLES

ITEM	PART NO.	DESCRIPTION	QTY
		1 2 3 4	
1	<u>1010934</u>	Screw, 5/16-18 X 1.00 Hex Cap	1
2	<u>1012328</u>	Battery, 12-Volt	1
3	<u>1014288</u>	Screw, 5/16-18 X 0.75, Thread-Forming	1
4	<u>1014375</u>	Screw, 3/8-16 X 0.50, Stainless Steel, Hex-Head	2
5	<u>101898001</u>	Clamp, Battery	1
6	<u>102355301</u>	Lockwasher, 3/8 Split Ss	2
7	<u>1241</u>	Washer, 5/16 Type A Flat	2
8	<u>7173</u>	Screw, 5/16-18 X 0.75, Hex-Head Cap	1
9	<u>7473</u>	Locknut, 5/16-18 Nylon Insert	2

7
G

7

G

FE290 ENGINE

8

G

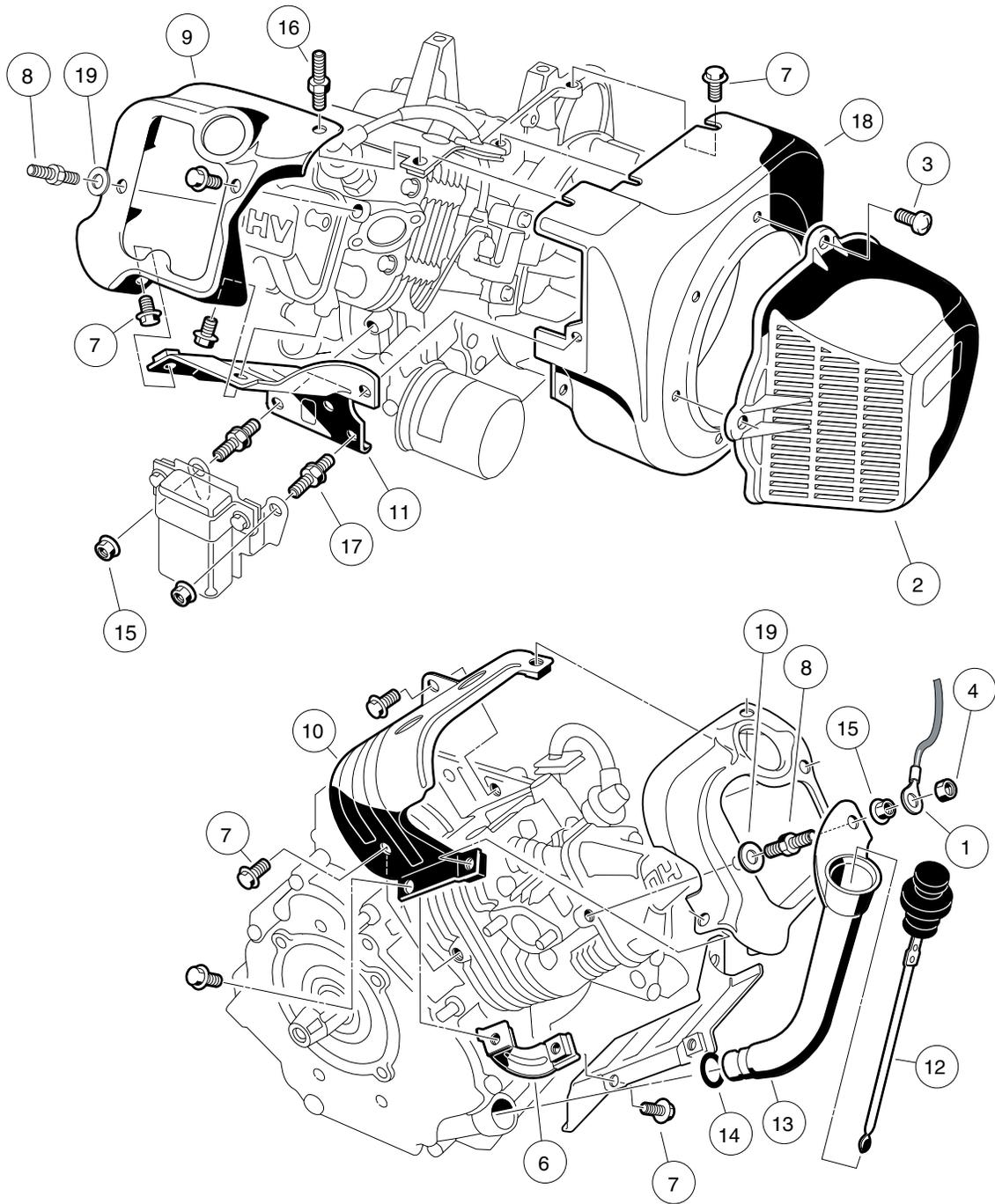

000194-001

FE290 ENGINE – SHROUDS AND BRACKETS

ITEM	PART NO.	DESCRIPTION	QTY
		1 2 3 4	
1	<u>1015332</u>	Wire, Ground, #10, Uninsulated	1
2	<u>1015649</u>	Shroud, Fan	1
3	<u>1015969</u>	Screw, M6-1.00 X 10mm, Pan Hd	4
4	<u>101887601</u>	Locknut, M6-1.00 Nylon Insert	1
5	<u>101953901</u>	Engine, FE290 (cw) * (includes items 6 through 19)	1
6	<u>1016443</u>	Bracket	1
7	<u>1016456</u>	Bolt, Flange Head, M6 x 1 x 12 mm	15
8	<u>1016507</u>	Bolt, Two-Ended	1
9	<u>1016524</u>	Shroud, Engine, FE290D	1
10	<u>1016525</u>	Shroud, Engine, FE290D	1
11	<u>1016526</u>	Shroud, Engine, FE290D	1
12	<u>1016531</u>	Dipstick	1
13	<u>1016536</u>	Tube, Oil Filler, FE290D	1
14	<u>1016539</u>	O-Ring	1
15	<u>1016547</u>	Nut, M6 Flange	3
16	<u>1017221</u>	Screw, M6-1.00 Stud	1
17	<u>101909701</u>	Stud, M6-1.00, Two-Ended	2
18	<u>101915601</u>	Housing, FE290 Fan	1
19	N/A	Washer, 6 mm Flat	1
		* Note: FE290 engine component listings span several pages.	

8
G

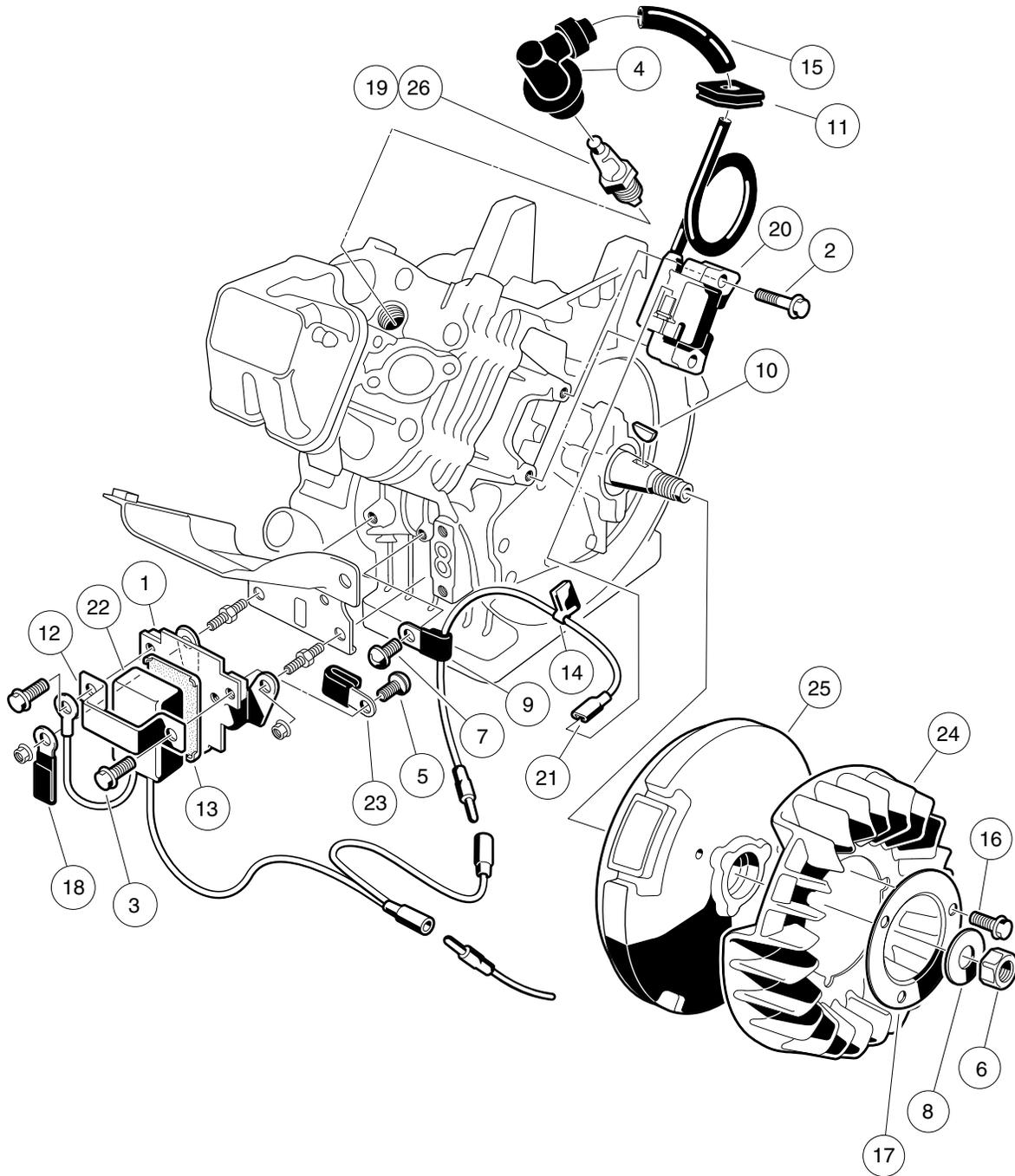

000195-001

FE290 ENGINE – IGNITION COMPONENTS AND FLYWHEEL

ITEM	PART NO.	DESCRIPTION	QTY
		1 2 3 4	
1	1016445	Bracket, RPM Limiter	1
2	<u>1016455</u>	Bolt, Flange Head	2
3	1016456	Bolt, Flange Head, M6 x 1 x 12 mm	2
4	<u>1016493</u>	Cap, Spark Plug	1
5	<u>1016497</u>	Screw, Pan WP Cross	1
6	<u>1016505</u>	Nut, Hex, Fine	1
7	<u>1016544</u>	Screw	1
8	<u>1016548</u>	Washer, M16 Flat	1
9	<u>1016561</u>	Clamp	1
10	<u>1016562</u>	Key	1
11	<u>1016578</u>	Grommet, Ignition	1
12	<u>1016579</u>	Band, RPM Limiter Mount	1
13	1016586	Damper, RPM Limiter	1
14	<u>1016587</u>	Clamp	1
15	<u>1016588</u>	Tube, 7mm X 10mm X 70mm	1
16	<u>1017448</u>	Bolt, Flanged	3
17	<u>1017455</u>	Plate, Flywheel Fan	1
18	<u>1017468</u>	Clamp	1
19	<u>101881101</u>	Spark Plug, OHV	1
20	<u>101909201</u>	Coil, Ignition	1
21	<u>101909301</u>	Lead Wire Assy	1
22	101909401	Limiter, RPM	1
23	101909501	Clamp, Steel	1
24	<u>101915801</u>	Fan, FE290 (cw)	1
25	<u>101929301</u>	Flywheel, Complete	1
26	<u>AM10724</u>	Spark Plug, OHV (NGK)	1

8
G

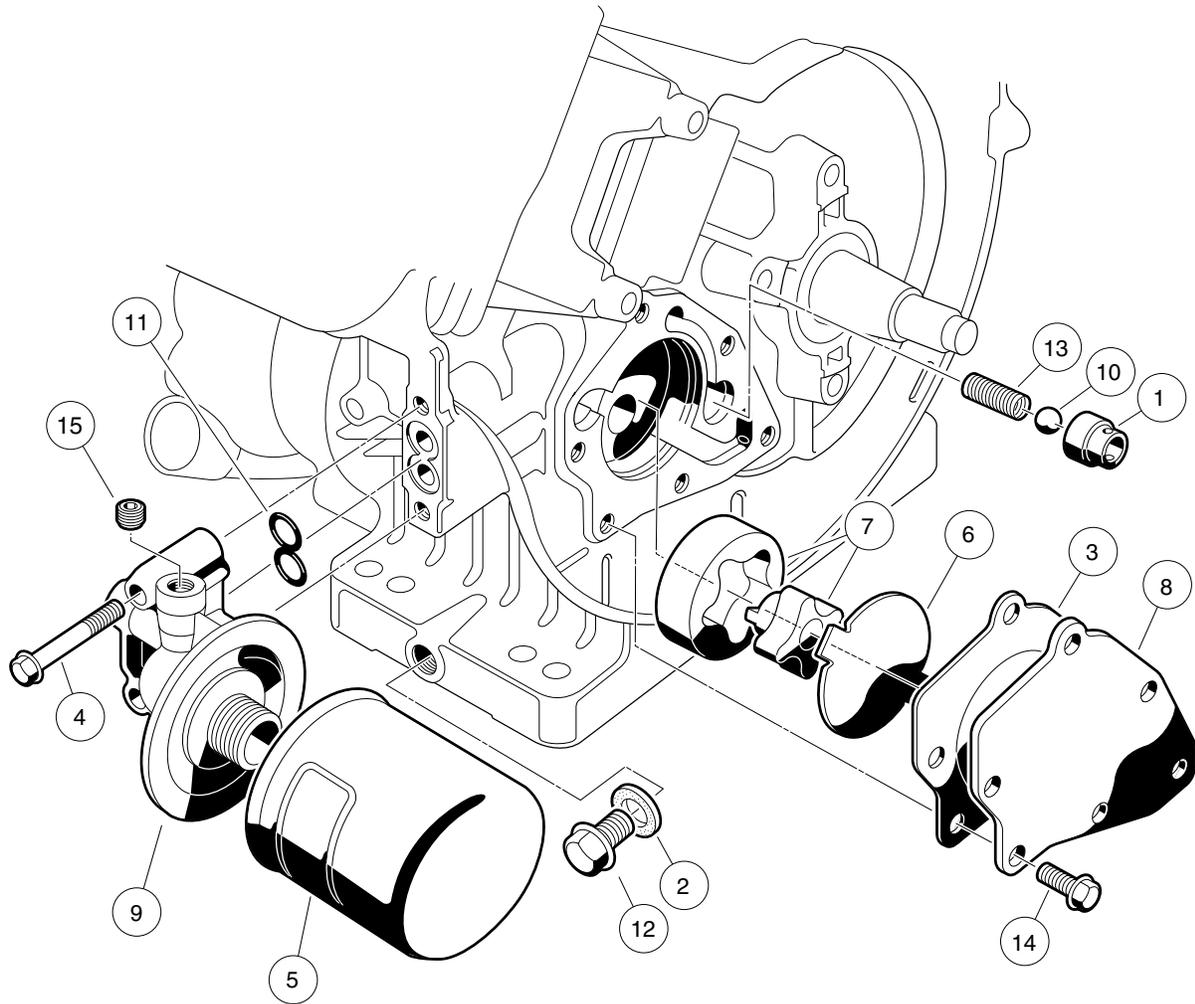

000196-001

FE290 ENGINE – OIL CIRCULATION

ITEM	PART NO.	DESCRIPTION	QTY	8
		1 2 3 4		G
1	1016429	Seat, Valve Oil Pressure Relief	1	
2	<u>1016432</u>	Gasket, Drain Plug	1	
3	<u>1016435</u>	Gasket, Oil Pump	1	
4	<u>1016457</u>	Bolt, Flange Head	2	
5	<u>1016467</u>	Filter, Oil	1	
6	<u>1016473</u>	Plate, Oil Pump	1	
7	<u>101648203</u>	Oil Pump And Rotor	1	
8	<u>1016484</u>	Cover, Pump	1	
9	<u>1016502</u>	Bracket, Oil Filter Mount	1	
10	<u>1016537</u>	Ball, Steel, Press, Relief	1	
11	<u>1016570</u>	O-Ring	1	
12	1016576	Plug, Drain	1	
13	<u>1016581</u>	Spring	1	
14	<u>1017456</u>	Bolt, Flanged	6	
15	<u>1017507</u>	Plug	2	

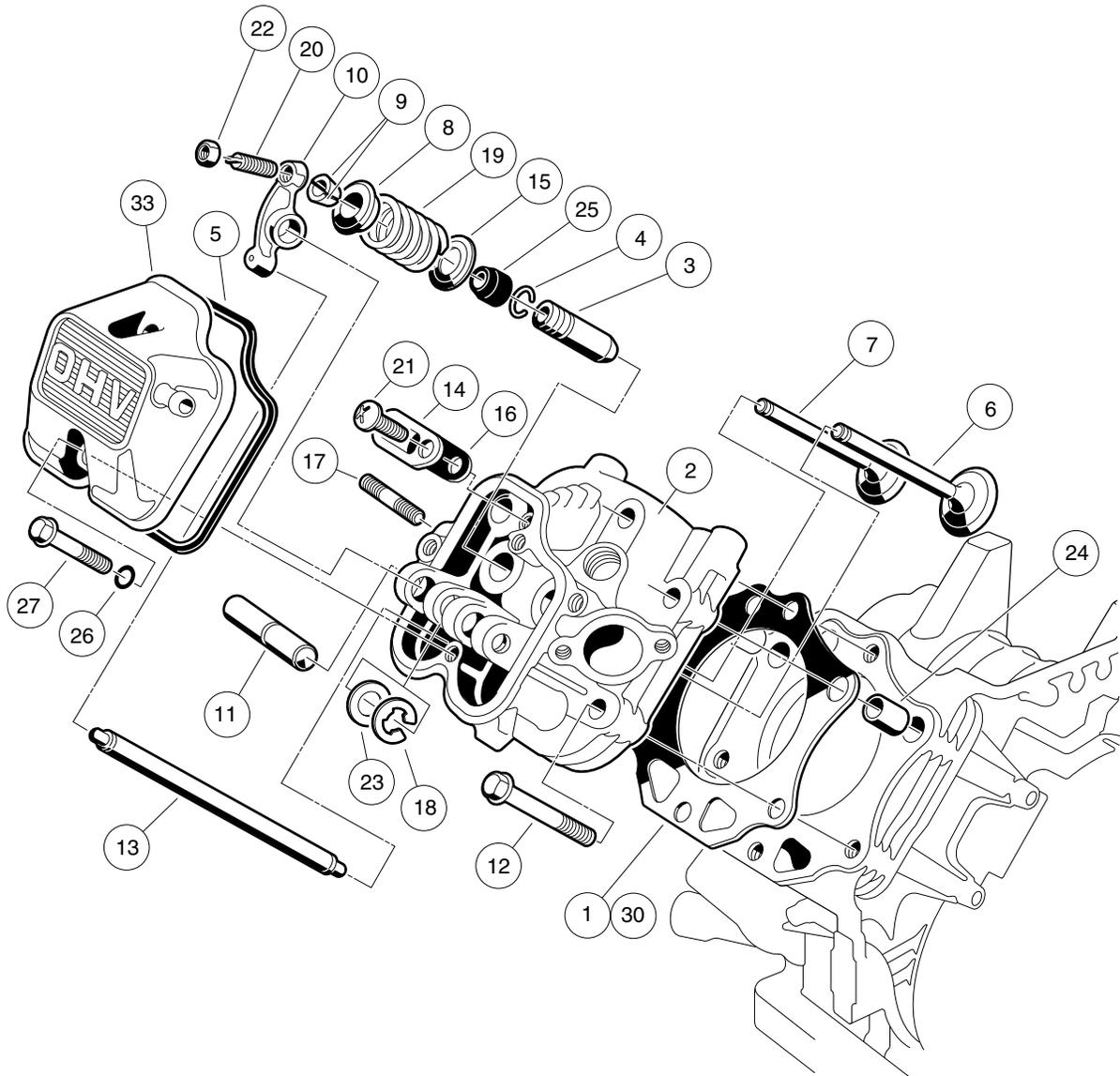

000197-001

FE290 ENGINE – CYLINDER HEAD

ITEM	PART NO.	DESCRIPTION	QTY
		1 2 3 4	
1	<u>1016430</u>	Gasket, Head, FE290	1
2	<u>1016431</u>	Head Assembly, FE290 Cylinder (includes items 3 and 4)	1
3	<u>1016519</u>	Guide, Valve, Intake, Exhaust	2
4	<u>1016560</u>	Snap Ring	2
5	<u>1016436</u>	Gasket, Rocker Case	1
6	<u>1016447</u>	Valve, Intake	1
7	<u>1016448</u>	Valve, Exhaust	1
8	<u>1016449</u>	Retainer, Valve Spring	2
9	<u>1016450</u>	Collet	4
10	<u>1016451</u>	Arm, Rocker	2
11	<u>1016452</u>	Shaft, Rocker	1
12	<u>1016458</u>	Bolt, Flange Head, M8 x 1.25 x 45 mm	6
13	<u>1016471</u>	Rod, Push	2
14	<u>1016474</u>	Plate	1
15	<u>1016479</u>	Seat, Spring	2
16	<u>1016483</u>	Valve	1
17	<u>1016489</u>	Stud, Two-Ended, M8-1.25	2
18	<u>1016517</u>	Circlip, Type-E	1
19	<u>1016523</u>	Spring, Engine Valve	2
20	<u>1016542</u>	Screw	2
21	<u>1016544</u>	Screw	1
22	<u>1016545</u>	Nut	2
23	<u>1016549</u>	Washer, 12.1x19x1.8	1
24	<u>1016563</u>	Pin	2
25	<u>1016566</u>	Seal, Oil	2
26	<u>1016569</u>	O-Ring	2
27	<u>1016583</u>	Bolt, 6x35	2
28	<u>102304701</u>	Kit, Gasket, FE290 (includes items 29 through 32)	1
29	<u>1015330</u>	Gasket, Exhaust	1
30	<u>1016430</u>	Gasket, Head, FE290	1
31	<u>1016440</u>	Gasket, Engine to Insulator	1
32	<u>1016446</u>	Gasket, Crankcase Cover	1
33	<u>102753401</u>	Case, Rocker	1

8

G

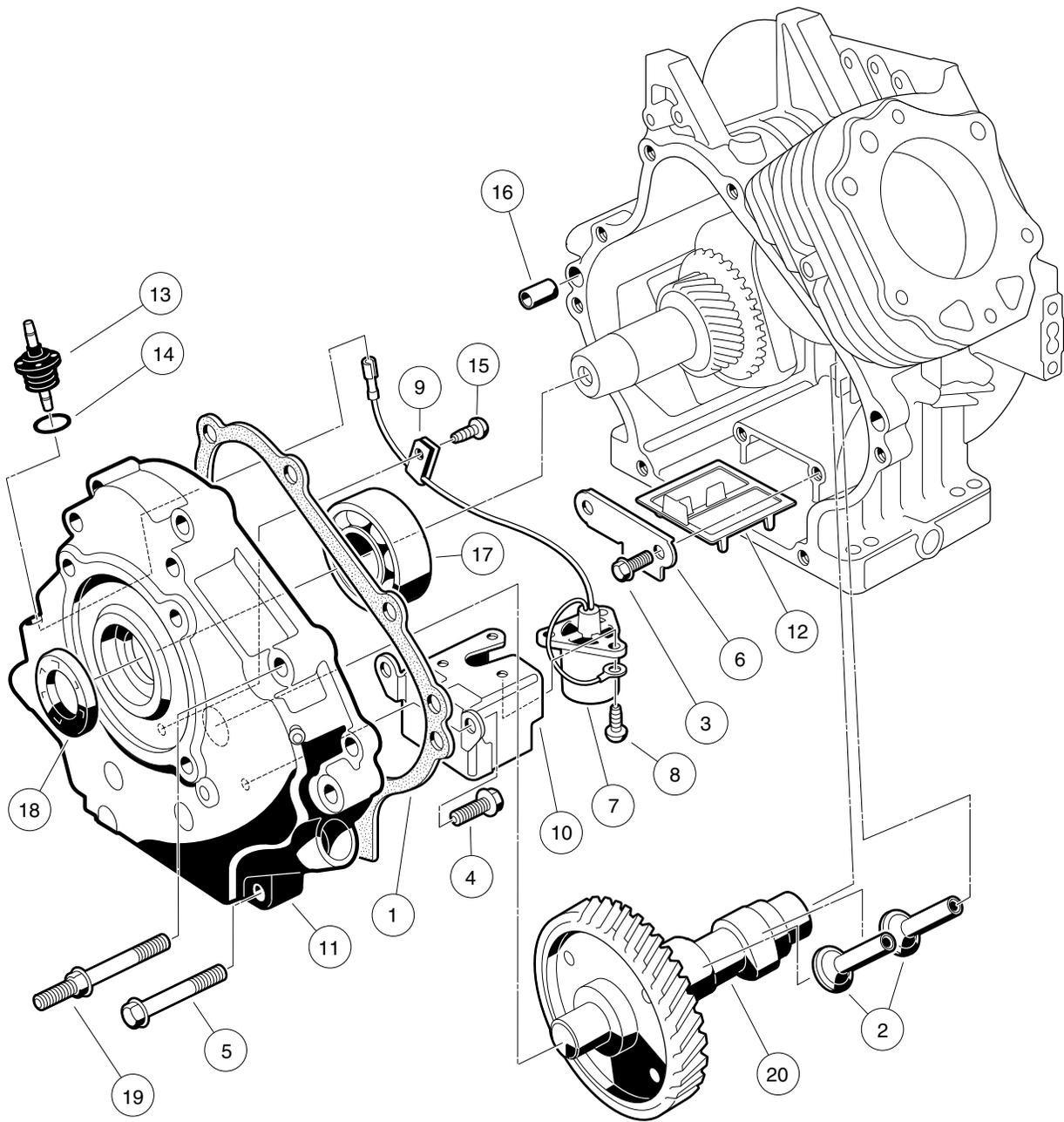

000198-001

FE290 ENGINE – CRANKCASE, CAMSHAFT, AND OIL SENSOR

ITEM	PART NO.	DESCRIPTION	QTY
		1 2 3 4	
1	<u>1016446</u>	Gasket, Crankcase Cover	1
2	<u>1016453</u>	Tappet	2
3	<u>1016454</u>	Bolt, Flange Head, M5 x 0.8 x 8 mm	2
4	<u>1016456</u>	Bolt, Flange Head, M6 x 1 x 12 mm	2
5	<u>1016458</u>	Bolt, Flange Head, M8 x 1.25 x 45 mm	6
6	<u>1016472</u>	Plate, Oil Filter Screen	1
7	<u>1016494</u>	Sensor, Oil Level	1
8	<u>1016496</u>	Screw, Cross Pan-Head, M4 x 0.7 x 8 mm	3
9	<u>1016506</u>	Clamp	1
10	<u>1016510</u>	Bracket, Switch, Oil Level	1
11	<u>1016520</u>	Cover, Crankcase	1
12	<u>1016521</u>	Screen, Oil Filter	1
13	<u>1016535</u>	Connector, Cord	1
14	<u>1016538</u>	O-Ring	1
15	<u>1016544</u>	Screw	1
16	<u>1016564</u>	Pin	2
17	<u>1016565</u>	Bearing, Ball	1
18	<u>1016567</u>	Seal, Crankshaft	1
19	<u>1016584</u>	Bolt, Two-Ended, M8 x 1.25 x 69 mm	2
20	<u>101915401</u>	Camshaft Complete, FE290	1

8

G

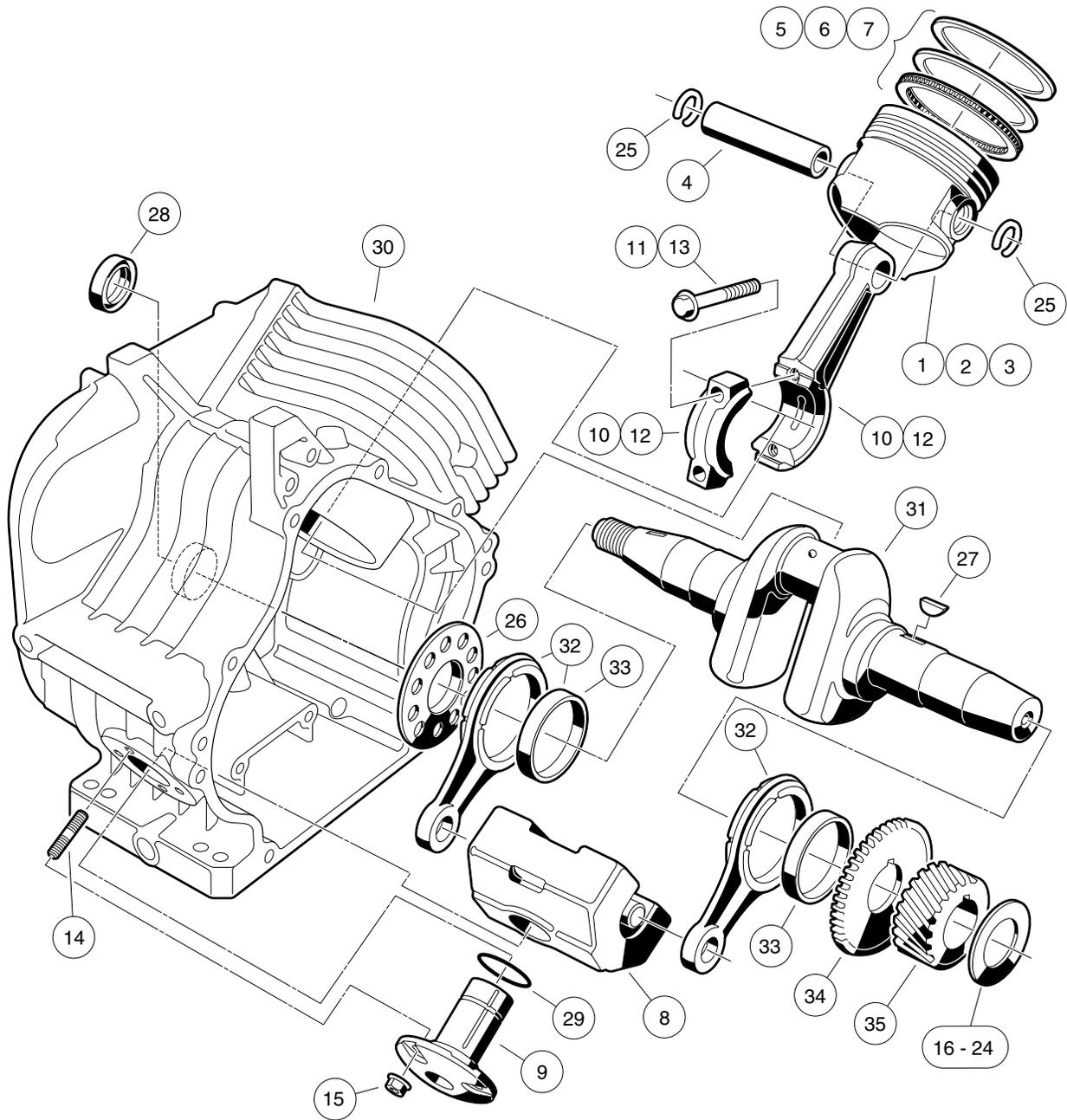

000199-001

FE290 ENGINE – CRANKCASE AND CRANKSHAFT

ITEM	PART NO.	DESCRIPTION	QTY
		1 2 3 4	
1	<u>101645901</u>	Piston	1
2	<u>101645902</u>	Piston, Engine 0.25 mm Over	1
3	<u>101645903</u>	Piston, Engine 0.50 mm Over	1
4	<u>1016460</u>	Pin, Piston	1
5	<u>101646101</u>	Ring Set, Piston	1
6	<u>101646102</u>	Ring Set, Piston 0.25 mm Over	1
7	<u>101646103</u>	Ring Set, Piston 0.50 mm Over	1
8	<u>1016469</u>	Weight, Counterbalance	1
9	<u>1016470</u>	Shaft, Guide, Counterbalance	1
10	<u>101647501</u>	Rod Assembly (includes item 11)	1
11	<u>1016509</u>	Bolt	2
12	<u>101647502</u>	Rod Assembly, Connecting 0.50 mm Under (includes item 13)	1
13	<u>1016509</u>	Bolt	2
14	<u>1016541</u>	Stud, 6x14	4
15	<u>1016547</u>	Nut, M6 Flange	4
16	<u>101655001</u>	Shim, Crankshaft T=1.13	1
17	<u>101655002</u>	Shim, Crankshaft T=1.18	1
18	<u>101655003</u>	Shim, Crankshaft T=1.23	1
19	<u>101655004</u>	Shim, Crankshaft T=1.28	1
20	<u>101655005</u>	Shim, Crankshaft T=1.33	1
21	<u>101655006</u>	Shim, Crankshaft T=1.38	1
22	<u>101655007</u>	Shim, Crankshaft T=1.43	1
23	<u>101655008</u>	Shim, Crankshaft T=1.48	1
24	<u>101655009</u>	Shim, Crankshaft T=1.53	1
25	<u>1016558</u>	Ring, Snap	2
26	<u>1016559</u>	Spacer	1
27	<u>1016562</u>	Key	1
28	<u>1016568</u>	Seal, Oil	1
29	<u>1016571</u>	O-Ring	1
30	<u>101915501</u>	Crankcase Complete, FE290 (cw)	1
31	<u>101922301</u>	Crankshaft, FE290 Left-Hand Thread (includes items 32 through 35)	1
32	<u>1016516</u>	Rod (includes item 33)	2
33	<u>1016580</u>	Bearing, Plane	1
34	<u>1016532</u>	Gear, Spur	1
35	<u>1016533</u>	Gear, Helical	1

8
G

8
G

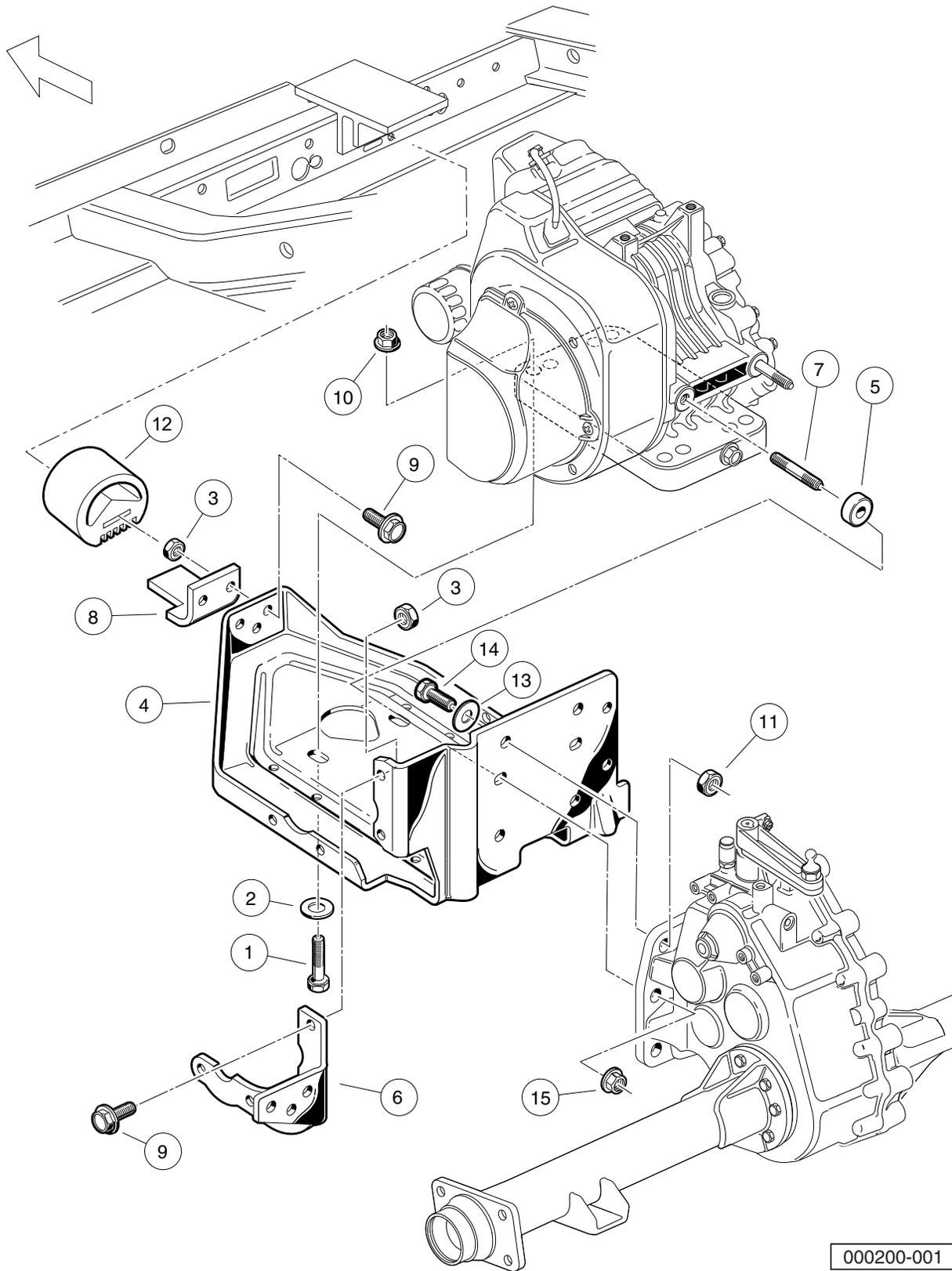

000200-001

FE290 ENGINE MOUNTING

ITEM	PART NO.	DESCRIPTION	QTY
		1 2 3 4	
1	<u>1010577</u>	Bolt, Hex-Head, 5/16-18 X 1.50	4
2	<u>1012571</u>	Washer, 5/16 Extra Thick Flat	4
3	<u>1013924</u>	Nut, 5/16-24, Hex Head Cone	6
4	<u>101827101</u>	Plate, Engine Mounting	1
5	<u>101832101</u>	Spacer, Powdered Metal	2
6	<u>101832701</u>	Stiffener (Flywheel Side)	1
7	<u>101833201</u>	Stud, M8-1.25 X 60mm Two-Ended	2
8	<u>101834601</u>	Bracket, Snubber	1
9	<u>101884801</u>	Screw, 5/16-24 X 0.875, Grade-8	6
10	<u>101963401</u>	Locknut, 5/16-18 Hex Flange	4
11	<u>102065901</u>	Locknut, 3/8-16 Flanged Dimple	4
12	<u>102540301</u>	Snubber, Inner Frame	1
13	<u>334</u>	Washer, 3/8, Type A, Flat	4
14	<u>705</u>	Screw, Cap-hex Hd 3/8-16x1.25	4
15	<u>96704416</u>	Nut, Flange, M8 X 1.25 Serrated	2

8

G

8

G

AS11 FE350 ENGINE

9

G

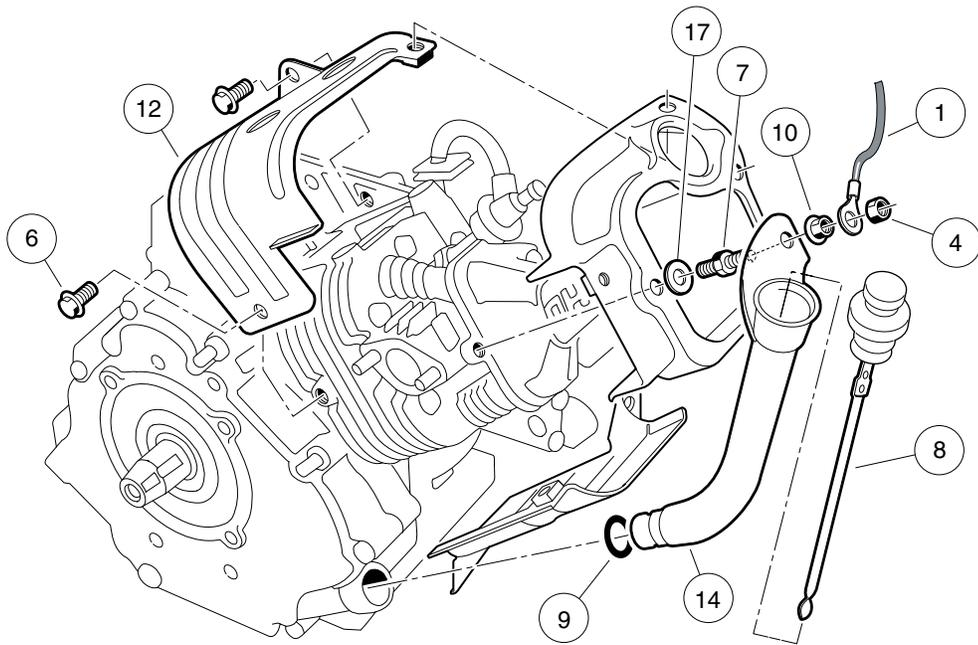
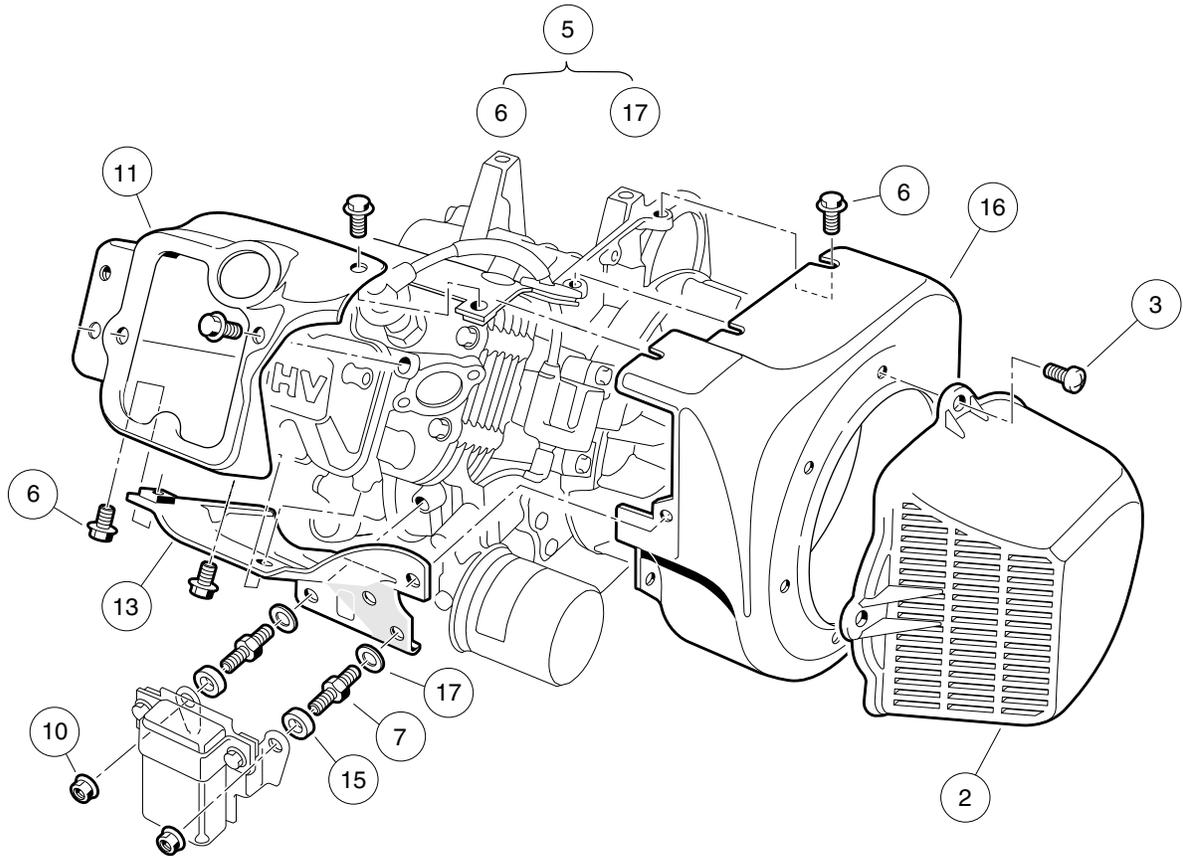

000201-001

FE350 ENGINE WITHOUT ACR (AUTOMATIC COMPRESSION RELEASE) – SHROUDS AND BRACKETS

ITEM	PART NO.	DESCRIPTION	QTY
		1 2 3 4	
1	<u>1015332</u>	Wire, Ground, #10, Uninsulated	1
2	<u>1015649</u>	Shroud, Fan	1
3	<u>1015969</u>	Screw, M6-1.00 X 10mm, Pan Hd	4
4	<u>101887601</u>	Locknut, M6-1.00 Nylon Insert	1
5	<u>101953802</u>	Engine, FE350, without ACR (includes items 6 through 17)	1
6	1016456	Bolt, Flange Head, M6 x 1 x 12 mm	14
7	<u>1016507</u>	Bolt, Two-Ended	3
8	1016531	Dipstick	1
9	<u>1016539</u>	O-Ring	1
10	1016547	Nut, M6 Flange	3
11	<u>1017474</u>	Shroud, Engine	1
12	<u>1017475</u>	Shroud, Engine	1
13	<u>1017476</u>	Shroud, Engine	1
14	<u>1017486</u>	Tube, Oil Filler	1
15	<u>1017500</u>	Spacer 6.50 X 12 X 5.5	2
16	<u>101916101</u>	Housing, FE350 Fan	1
17	N/A	Washer, 6mm Flat	3

9

G

FE350 ENGINE – IGNITION-COMPONENTS-AND-FLYWHEEL

ITEM	PART NO.	DESCRIPTION	QTY
		1 2 3 4	
1	1016445	Bracket, RPM Limiter	1
2	<u>1016455</u>	Bolt, Flange Head	2
3	1016456	Bolt, Flange Head, M6 x 1 x 12 mm	2
4	<u>1016497</u>	Screw, Pan WP Cross	1
5	<u>1016544</u>	Screw	1
6	<u>1016561</u>	Clamp	1
7	<u>1016562</u>	Key	1
8	<u>1016578</u>	Grommet, Ignition	1
9	<u>1016579</u>	Band, RPM Limiter Mount	1
10	1016586	Damper, RPM Limiter	1
11	<u>1016587</u>	Clamp	1
12	<u>1016588</u>	Tube, 7mm X 10mm X 70mm	1
13	<u>1017448</u>	Bolt, Flanged	3
14	<u>1017455</u>	Plate, Flywheel Fan	1
15	<u>1017463</u>	Cap Asm, Plug	1
16	<u>1017468</u>	Clamp	1
17	<u>1017490</u>	Washer, Flat	1
18	<u>101881101</u>	Spark Plug, OHV	1
19	<u>101909201</u>	Coil, Ignition	1
20	<u>101909301</u>	Lead Wire Assy	1
21	101909401	Limiter, RPM	1
22	101909501	Clamp, Steel	1
23	<u>101916201</u>	Flywheel	1
24	<u>101916301</u>	Fan (cw)	1
25	<u>102838401</u>	Nut, Hex, 18 mm Fine	1
26	<u>AM10724</u>	Spark Plug, OHV (NGK)	1

9

G

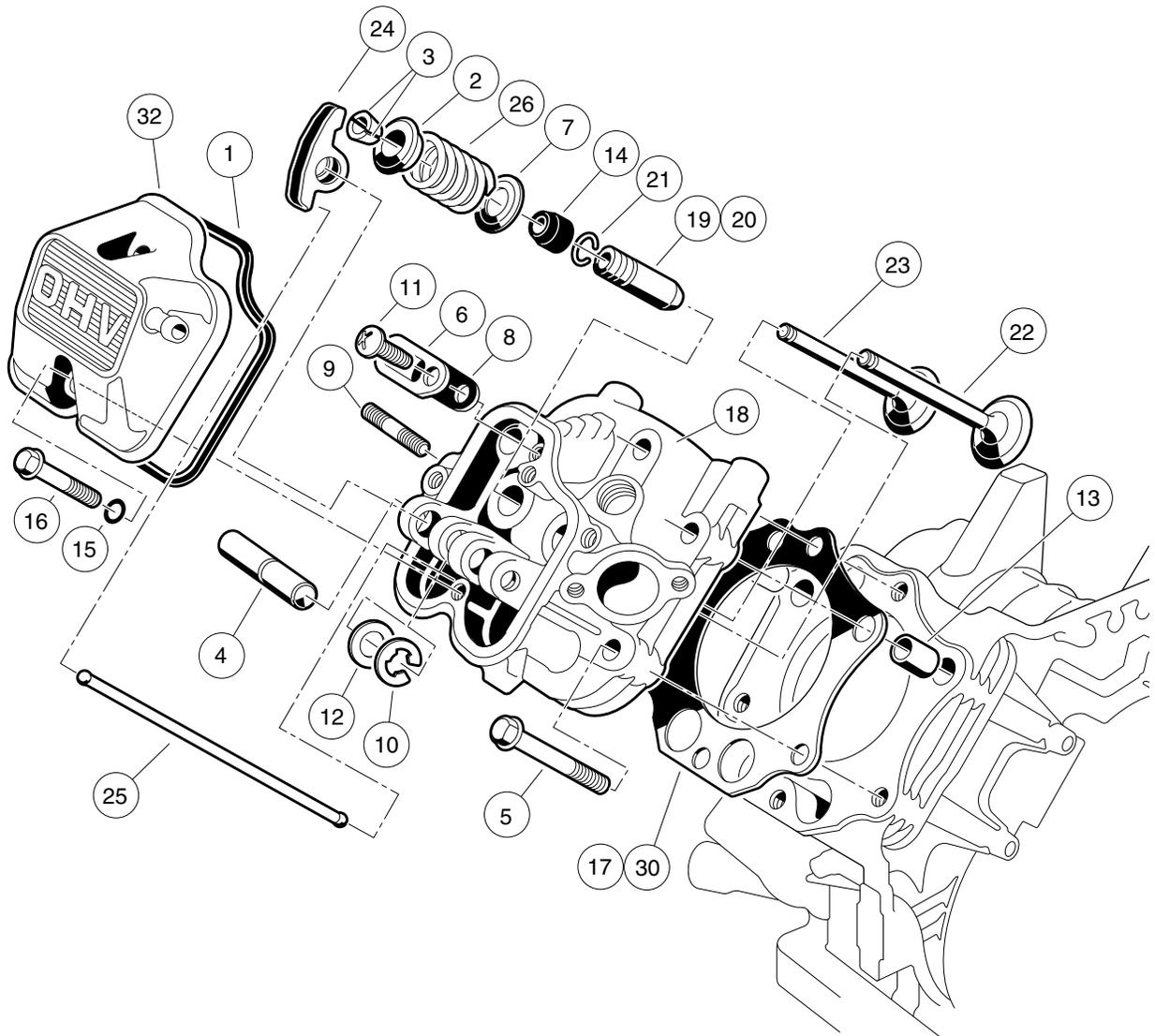

000204-001

FE350 ENGINE – CYLINDER HEAD

ITEM	PART NO.	DESCRIPTION	QTY
		1 2 3 4	
1	<u>1016436</u>	Gasket, Rocker Case	1
2	<u>1016449</u>	Retainer, Valve Spring	2
3	<u>1016450</u>	Collet	4
4	<u>1016452</u>	Shaft, Rocker	1
5	<u>1016458</u>	Bolt, Flange Head, M8 x 1.25 x 45 mm	6
6	<u>1016474</u>	Plate	1
7	<u>1016479</u>	Seat, Spring	2
8	<u>1016483</u>	Valve	1
9	<u>1016489</u>	Stud, Two-Ended, M8-1.25	2
10	<u>1016517</u>	Circlip, Type-E	1
11	<u>1016544</u>	Screw	1
12	<u>1016549</u>	Washer, 12.1x19x1.8	1
13	<u>1016563</u>	Pin	2
14	<u>1016566</u>	Seal, Oil	2
15	<u>1016569</u>	O-Ring	2
16	<u>1016583</u>	Bolt, 6x35	2
17	<u>1017434</u>	Gasket, Head	1
18	<u>1017435</u>	Assembly, Cylinder Head, FE350 (includes items 19 through 21)	1
19	<u>1016518</u>	Guide, Valve, Exhaust	1
20	<u>1016519</u>	Guide, Valve, Intake, Exhaust	1
21	<u>1016560</u>	Snap Ring	2
22	<u>1017444</u>	Valve, Intake	1
23	<u>1017445</u>	Valve, Exhaust	1
24	<u>1017446</u>	Arm, Rocker	2
25	<u>1017454</u>	Rod, Push	2
26	<u>1017473</u>	Spring, Engine Valve	2
27	<u>102304801</u>	Kit, Gasket, FE350 (includes items 28 through 31)	1
28	<u>1016440</u>	Gasket, Engine to Insulator	1
29	<u>1016904</u>	Gasket, Exhaust	1
30	<u>1017434</u>	Gasket, Head	1
31	<u>1017443</u>	Gasket, Crankcase Cover	1
32	<u>102753401</u>	Case, Rocker	1
		Note: Item 28 is not a component of the FE350 engine.	

9

G

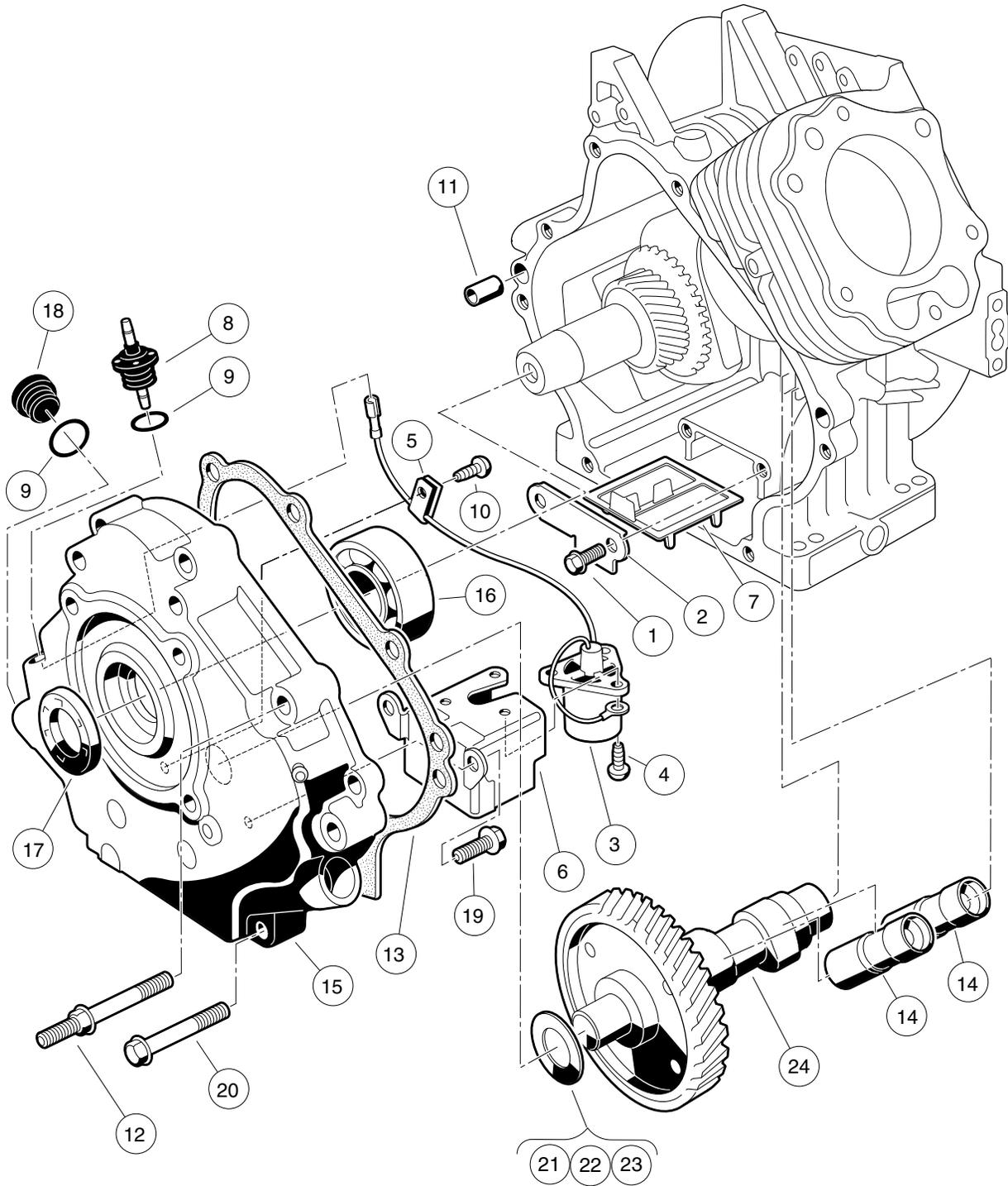

000205-002

FE350 ENGINE WITHOUT ACR – CRANKCASE,-CAMSHAFT,-AND- OIL-SENSOR

ITEM	PART NO.	DESCRIPTION	QTY
		1 2 3 4	
1	<u>1016454</u>	Bolt, Flange Head, M5 x 0.8 x 8 mm	2
2	<u>1016472</u>	Plate, Oil Filter Screen	1
3	<u>1016494</u>	Sensor, Oil Level	1
4	<u>1016496</u>	Screw, Cross Pan-Head, M4 x 0.7 x 8 mm	3
5	<u>1016506</u>	Clamp	1
6	<u>1016510</u>	Bracket, Switch, Oil Level	1
7	<u>1016521</u>	Screen, Oil Filter	1
8	<u>1016535</u>	Connector, Cord	1
9	<u>1016538</u>	O-Ring	2
10	<u>1016544</u>	Screw	1
11	<u>1016564</u>	Pin	2
12	<u>1016584</u>	Bolt, Two-Ended, M8 x 1.25 x 69 mm	2
13	<u>1017443</u>	Gasket, Crankcase Cover	1
14	<u>1017447</u>	Adjuster, Lash	2
15	<u>1017472</u>	Cover Crankcase	1
16	<u>1017487</u>	Bearing, Ball	1
17	<u>1017504</u>	Seal, Oil	1
18	<u>1017508</u>	Plug	1
19	<u>1017513</u>	Bolt Switch Bracket	2
20	<u>1017514</u>	Screw, M8-1.25 X 45mm Hex	6
21	<u>101751801</u>	Shim, 0.3	1
22	<u>101751802</u>	Shim, 0.4	1
23	<u>101751803</u>	Shim, 0.5	1
24	<u>102431001</u>	Camshaft, FE350 without ACR, 44-Tooth	1

9
G

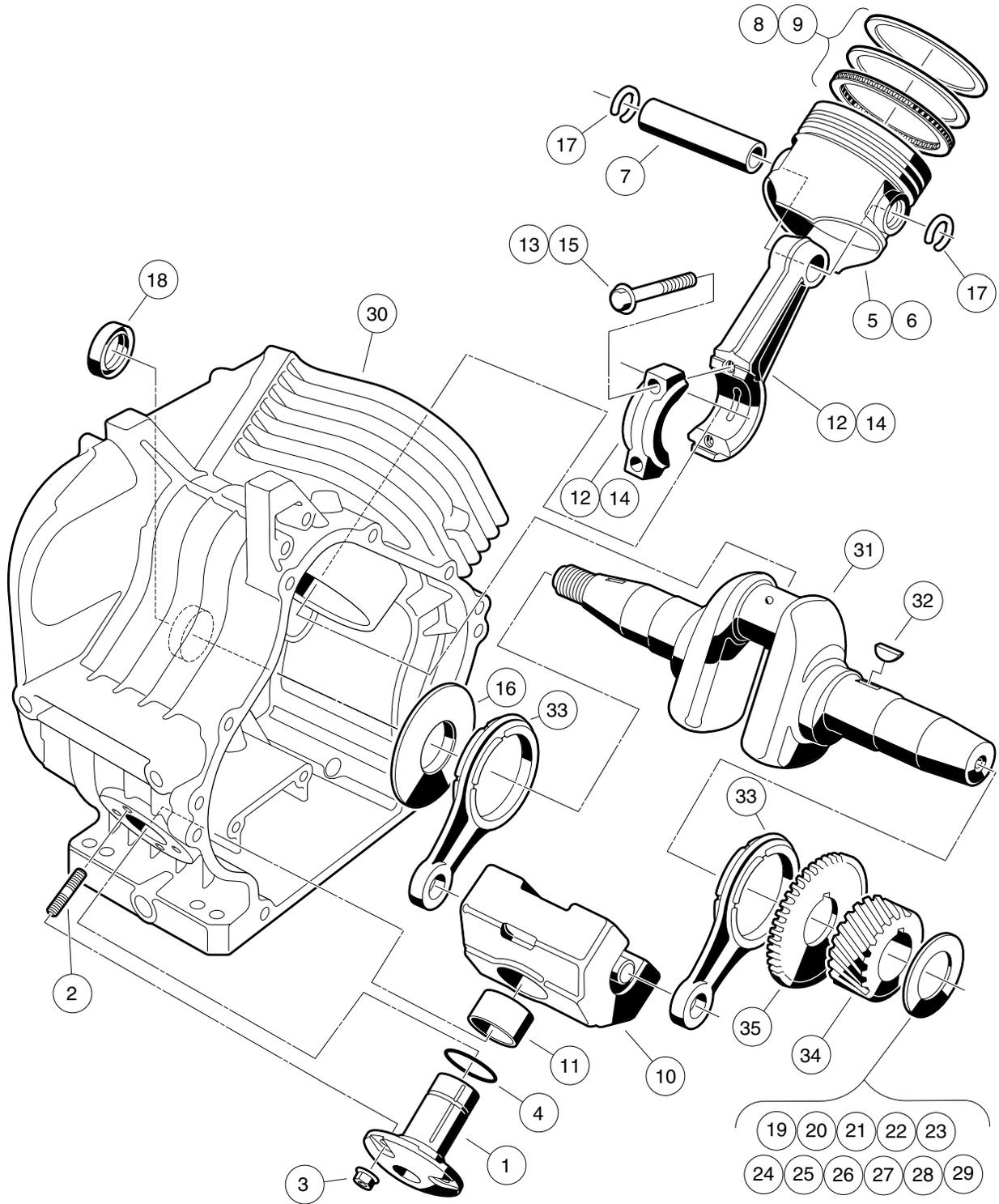

000206-001

FE350 ENGINE – CRANKCASE-AND-CRANKSHAFT

ITEM	PART NO.	DESCRIPTION	QTY
		1 2 3 4	
1	1016470	Shaft, Guide, Counterbalance	1
2	<u>1016541</u>	Stud, 6x14	4
3	1016547	Nut, M6 Flange	4
4	<u>1016571</u>	O-Ring	1
5	<u>101744901</u>	Piston, Standard	1
6	<u>101744902</u>	Piston, 0.50 mm Oversize	1
7	1017450	Pin, Piston	1
8	<u>101745101</u>	Ring Set, Standard Piston	1
9	<u>101745102</u>	Ring Set, Piston, 0.50 mm Oversize	1
10	<u>1017453</u>	Counterbalance Weight (includes item 11)	1
11	1017510	Bearing, Plain	1
12	101745701	Asm, Con. Rod Std (includes item 13)	1
13	<u>1017512</u>	Bolt	2
14	<u>101745702</u>	Asm,Con.Rod 0.5mm U/s (includes item 15)	1
15	<u>1017512</u>	Bolt	2
16	1017501	Spacer	1
17	<u>1017502</u>	Snap Ring	2
18	<u>1017503</u>	Seal, Oil	1
19	<u>101773301</u>	Shim, Crankshaft, 1.18mm	1
20	<u>101773302</u>	Shim, Crankshaft, 1.25mm	1
21	<u>101773303</u>	Shim, Crankshaft, 1.32mm	1
22	<u>101773304</u>	Shim, Crankshaft, 1.39mm	1
23	<u>101773305</u>	Shim, Crankshaft, 1.46mm	1
24	<u>101773306</u>	Shim, Crankshaft, 1.53mm	1
25	<u>101773307</u>	Shim, Crankshaft, 1.60mm	1
26	<u>101773308</u>	Shim, Crankshaft, 1.67mm	1
27	<u>101773309</u>	Shim, Crankshaft, 1.74mm	1
28	<u>101773310</u>	Shim, Crankshaft, 1.11 mm	1
29	<u>101773311</u>	Shim, Crankshaft, 1.81mm	1
30	<u>101916001</u>	Crankcase Complete, FE350 (cw)	1
31	<u>102430901</u>	Crankshaft, FE350 Left-Hand, 22-Tooth (includes items 32 through 35)	1
32	<u>1016562</u>	Key	1
33	<u>1017471</u>	Rod	2
34	N/A	Gear, Helical	1
35	N/A	Gear, Spur	1

9

G

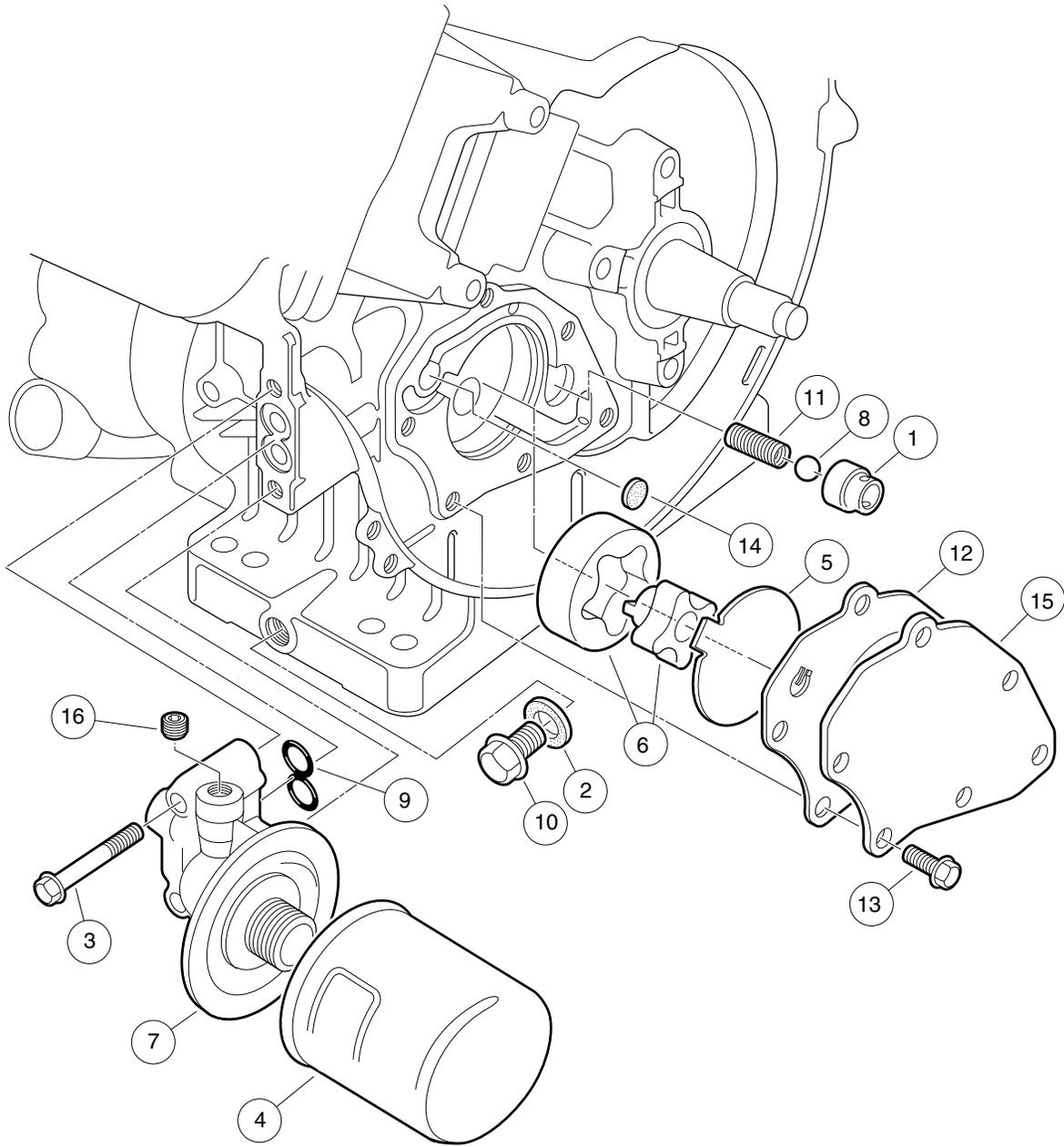

000203-001

FE350 ENGINE (AS26)- OIL CIRCULATION

ITEM	PART NO.	DESCRIPTION	QTY
		1 2 3 4	
1	1016429	Seat, Valve Oil Pressure Relief	1
2	<u>1016432</u>	Gasket, Drain Plug	1
3	<u>1016457</u>	Bolt, Flange Head	2
4	<u>1016467</u>	Filter, Oil	1
5	<u>1016473</u>	Plate, Oil Pump	1
6	<u>101648203</u>	Oil Pump And Rotor	1
7	<u>1016502</u>	Bracket, Oil Filter Mount	1
8	<u>1016537</u>	Ball, Steel, Press, Relief	1
9	<u>1016570</u>	O-Ring	1
10	1016576	Plug, Drain	1
11	<u>1016581</u>	Spring	1
12	<u>1017442</u>	Gasket	1
13	<u>1017456</u>	Bolt, Flanged	6
14	<u>1017458</u>	Filter	1
15	<u>1017460</u>	Cover, Pump	1
16	<u>1017507</u>	Plug	2

9

G

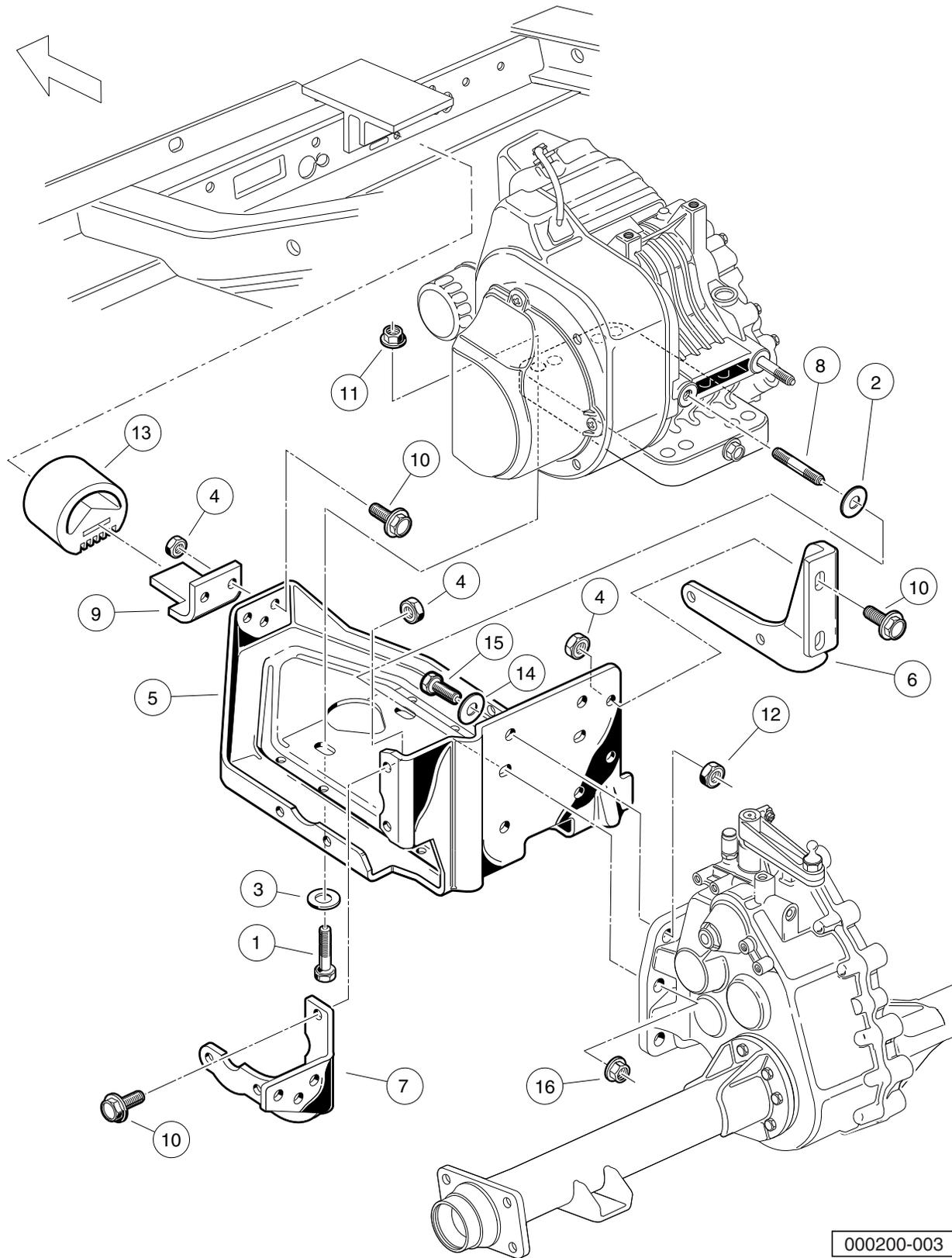

000200-003

FE350 ENGINE (AS26)- MOUNTING

ITEM	PART NO.	DESCRIPTION	QTY
		1 2 3 4	
1	<u>1010577</u>	Bolt, Hex-Head, 5/16-18 X 1.50	4
2	<u>1011697</u>	Washer, 5/16 Flat	2
3	1012571	Washer, 5/16 Extra Thick Flat	4
4	<u>1013924</u>	Nut, 5/16-24, Hex Head Cone	10
5	<u>101827101</u>	Plate, Engine Mounting	1
6	<u>101832601</u>	Stiffener (PTO Side)	1
7	<u>101832701</u>	Stiffener (Flywheel Side)	1
8	<u>101833101</u>	Stud, M8-1.25 X 50 mm Two-Ended	2
9	<u>101834601</u>	Bracket, Snubber	1
10	<u>101884801</u>	Screw, 5/16-24 X 0.875, Grade-8	10
11	<u>101963401</u>	Locknut, 5/16-18 Hex Flange	4
12	<u>102065901</u>	Locknut, 3/8-16 Flanged Dimple	4
13	<u>102540301</u>	Snubber, Inner Frame	1
14	<u>334</u>	Washer, 3/8, Type A, Flat	4
15	705	Screw, Cap-hex Hd 3/8-16x1.25	4
16	<u>96704416</u>	Nut, Flange, M8 X 1.25 Serrated	2

9

G

9

G

FUEL, INTAKE, AND GOVERNOR SYSTEMS

10

G

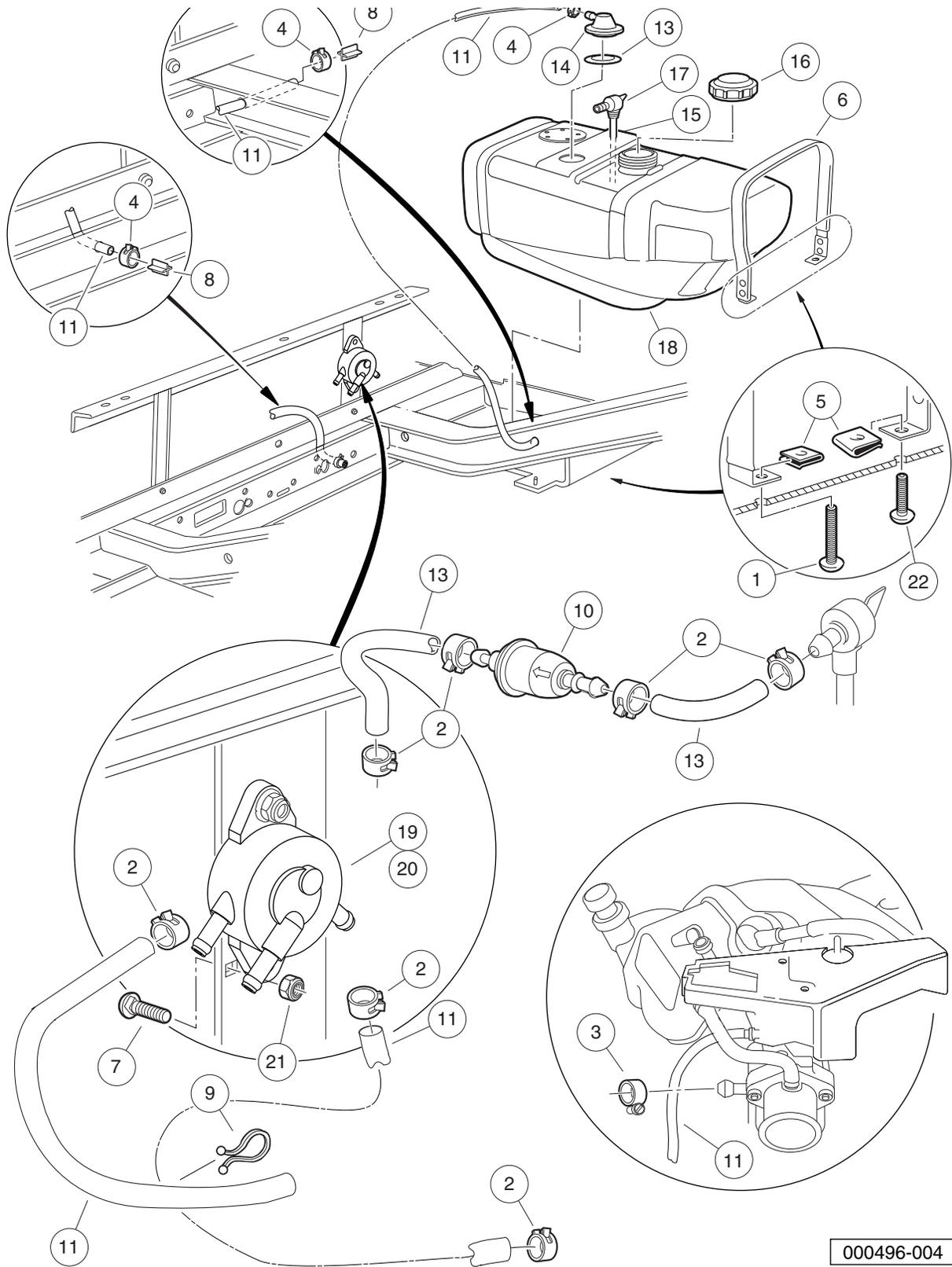

000496-004

FUEL SYSTEM

10
G

ITEM	PART NO.	DESCRIPTION	QTY
		1 2 3 4	
1	<u>1011988</u>	Screw, 1/4-20 X 2.00 Phillips Truss-Head	1
2	<u>1012649</u>	Clamp, 0.460 Red Hose	7
3	<u>1013687</u>	Clamp, 3/8" Hose (screw type)	1
4	<u>1013746</u>	Clamp, 0.301 ID Hose	3
5	<u>1014116</u>	Nut, 1/4-20 Speed	2
6	<u>1014928</u>	Fuel Strap Assembly Rear	1
7	<u>1017203</u>	Carriage Bolt	2
8	<u>101824401</u>	Vent Barb	2
9	<u>101987701</u>	Clamp, Plastic Tie	1
10	<u>102003201</u>	Filter, Fuel, 30 Micron	1
11	<u>102865101</u>	Fuel Line, 1/4 (available by the foot)	1
12	<u>103651902</u>	Asm, Tank, Ds Utl Wo/su† Nano (includes items 13 through 18)	1
13	<u>1015139</u>	Insulation Grommet	1
14	<u>1015143</u>	Vent, Fuel Tank	1
15	<u>102406701</u>	Bushing, Line, Return	1
16	<u>103372101</u>	Cap, Fuel Tank, Gas, Ratchet	1
17	<u>103372302</u>	Fuel Pickup w/Shut-Off Valve, 288mm	1
18	<u>103776902</u>	Tank, Fuel, Top, Wo/su Nano	1
19	<u>103781101</u>	Kit, Fuel Pump Retrofit (includes item 20)	1
20	<u>103010101</u>	Pump, Fuel, Impulse, Fh	1
21	<u>8233</u>	Locknut, 1/4-20, Nylon Insert	2
22	<u>8248</u>	Screw, 1/4-20 X 0.75, Truss-Head Machine	1
		 Note: Total fuel line length: 47 inches (119.4 cm)	

10
G

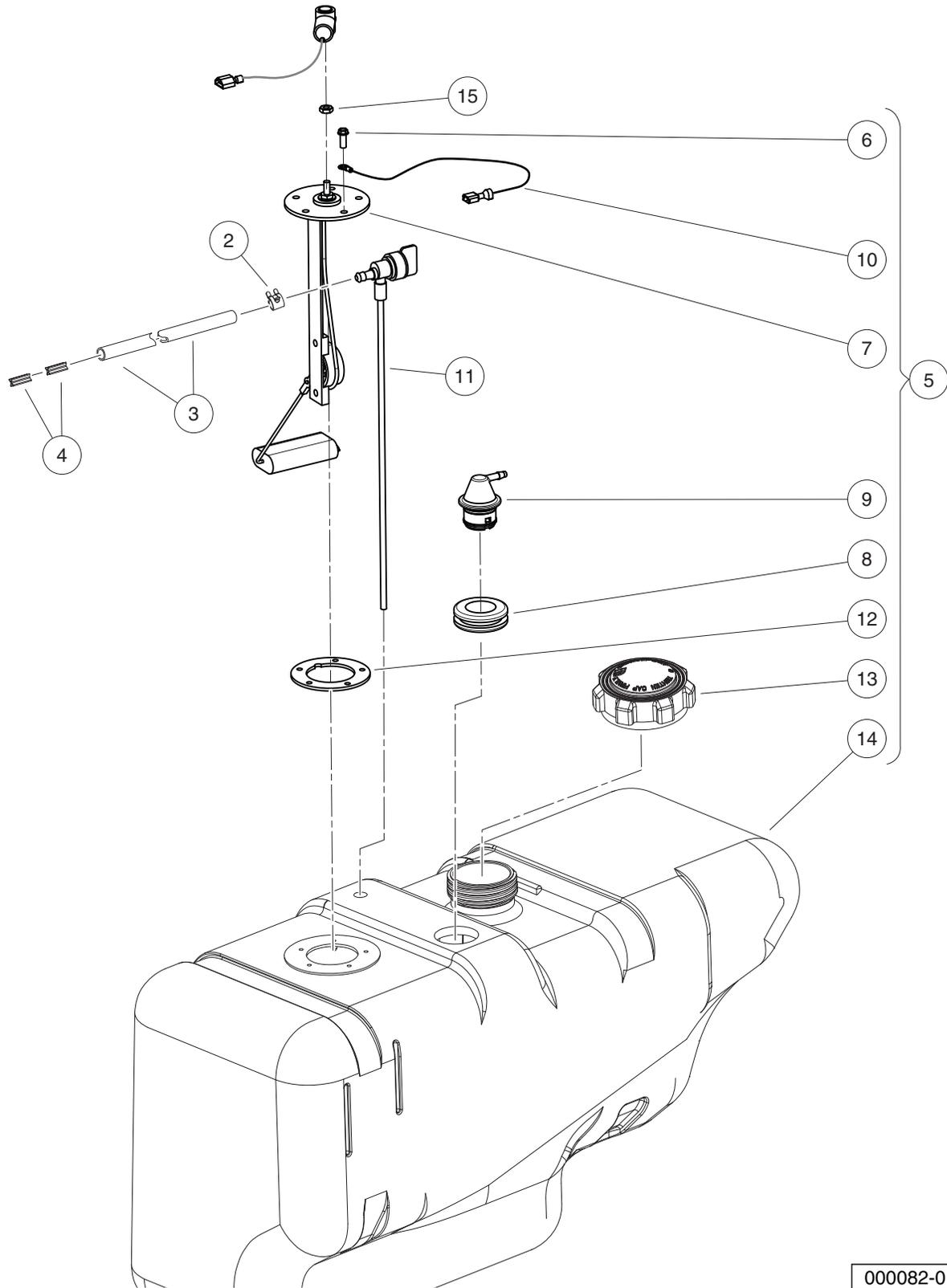

000082-013

FUEL TANK WITH FUEL LEVEL SENDING UNIT

ITEM	PART NO.	DESCRIPTION	QTY
		1 2 3 4	
1	1016004	Tank Kit w/Sending Unit (includes items 2 through 5)	1
2	<u>1013746</u>	Clamp, 0.301 ID Hose	2
3	<u>1015137</u>	Fuel Line, 3/16 (available by the foot)	1
4	<u>101824401</u>	Vent Barb	2
5	102952301	Fuel Tank with Sending Unit (includes items 6 through 14)	1
6	<u>1013461</u>	Screw, #10-16 Hex-Head Hi-Lo	5
7	<u>1013462</u>	Sending Unit, Fuel Level *	1
8	<u>1015139</u>	Insulation Grommet	1
9	<u>1015143</u>	Vent, Fuel Tank	1
10	1015921	Wire Assembly #16 Black	1
11	101896901	Fuel Pickup w/Shut-Off Valve	1
12	<u>102522001</u>	Gasket, Rubber	1
13	<u>102751601</u>	Cap, Fuel Tank, Gasoline	1
14	N/A	Tank, Fuel, W/su Ds Utl	1
15	<u>8797</u>	Nut, #10-32 Brass Hex	1
		* Note: Must replace fuel sending unit gasket when servicing this component.	

10
G

CARBURETOR ASSEMBLY – FE290

ITEM	PART NO.	DESCRIPTION	QTY
		1 2 3 4	
1	<u>101642572</u>	Jet, Altitude, # 72	1
2	<u>101642575</u>	Jet, Altitude, # 75	1
3	<u>101642578</u>	Jet, Altitude, # 78	1
4	<u>101642580</u>	Jet, Altitude, # 80	1
5	<u>101905601</u>	Carburetor Assembly, FE290D (includes items 6 through 15)	1
6	<u>101642582</u>	Jet, Altitude, # 82	1
7	<u>1016437</u>	Gasket, Carburetor Bowl OHV	1
8	<u>1016486</u>	Float Assembly	1
9	<u>1016501</u>	Screw Assembly	1
10	<u>1016585</u>	Bolt	1
11	<u>1017461</u>	Chamber Assembly, Float (includes item 12)	1
12	<u>1016499</u>	Screw Assembly	1
13	<u>101973101</u>	Jet, #40 Pilot	1
14	<u>101973201</u>	Nozzle, Main	1
15	N/A	Assembly, Pilot Air Screw	1
<p>Note: <u>101642582</u> for 0 - 3,000 feet; <u>101642580</u> for 3,000 - 5,000 feet; <u>101642578</u> for 5,000 - 8,000 feet; <u>101642575</u> for 8,000 - 10,000 feet; <u>101642572</u> for 10,000 feet and higher.</p>			

10

G

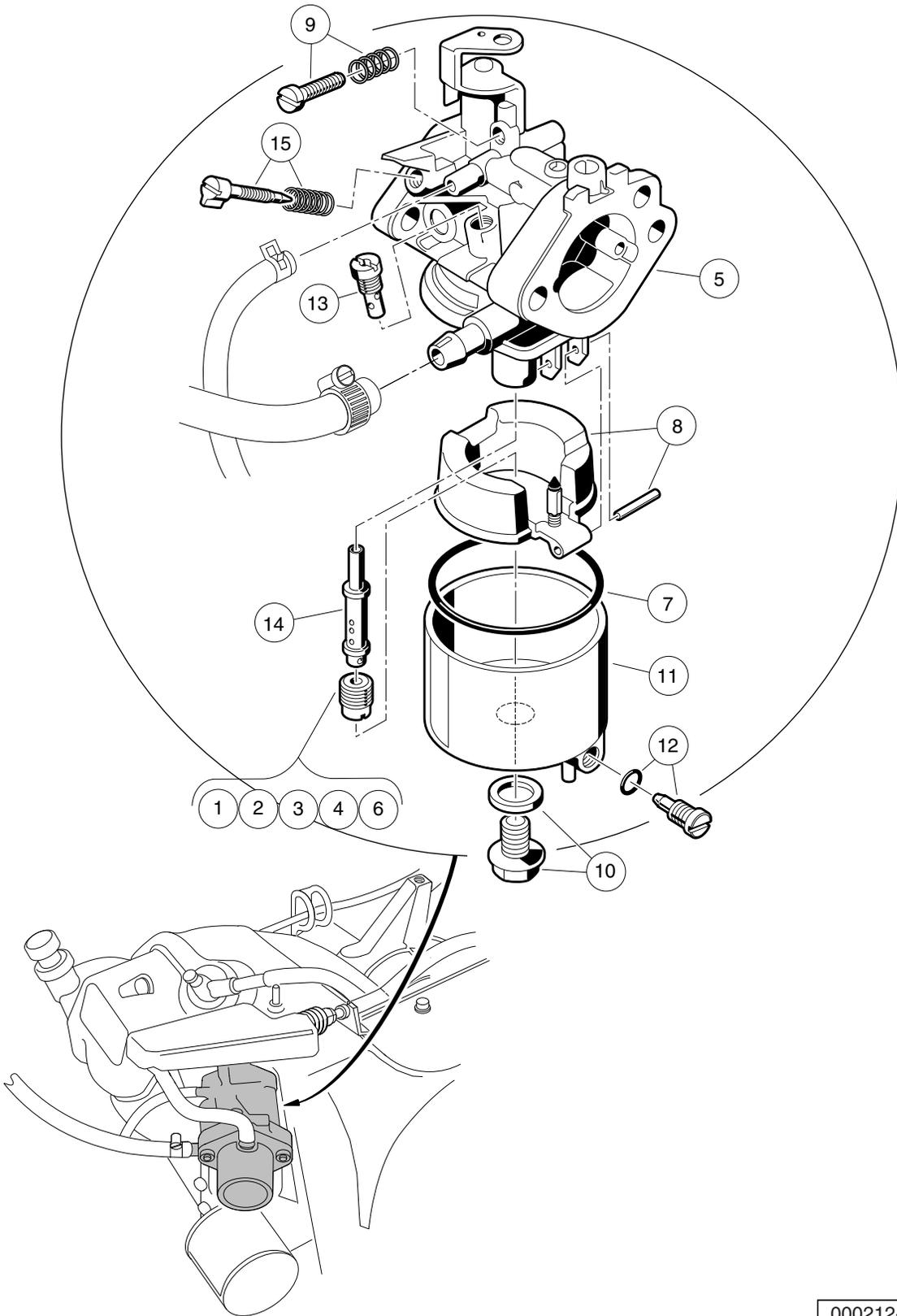

000212-001

CARBURETOR ASSEMBLY – FE350

ITEM	PART NO.	DESCRIPTION	QTY
		1 2 3 4	
1	<u>101642575</u>	Jet, Altitude, # 75	1
2	<u>101642578</u>	Jet, Altitude, # 78	1
3	<u>101642580</u>	Jet, Altitude, # 80	1
4	<u>101642582</u>	Jet, Altitude, # 82	1
5	<u>101905901</u>	Carburetor, FE350D (includes items 6 through 15)	1
6	<u>101642585</u>	Jet, Altitude, # 85	1
7	<u>1016437</u>	Gasket, Carburetor Bowl OHV	1
8	<u>1016486</u>	Float Assembly	1
9	<u>1016501</u>	Screw Assembly	1
10	<u>1016585</u>	Bolt	1
11	<u>1017461</u>	Chamber Assembly, Float (includes item 12)	1
12	<u>1016499</u>	Screw Assembly	1
13	<u>101973101</u>	Jet, #40 Pilot	1
14	<u>101973301</u>	Nozzle, Main	1
15	N/A	Assembly, Pilot Air Screw	1
<p>Note: <u>101642585</u> for 0 - 3,000 feet; <u>101642582</u> for 3,000 - 5,000 feet; <u>101642580</u> for 5,000 - 8,000 feet; <u>101642578</u> for 8,000 - 10,000 feet; <u>101642575</u> for 10,000 feet and higher.</p>			

10

G

CARBURETOR INSTALLATION – FE290

ITEM	PART NO.	DESCRIPTION	QTY
		1 2 3 4	
1	<u>1011697</u>	Washer, 5/16 Flat	1
2	<u>1013746</u>	Clamp, 0.301 ID Hose	1
3	<u>1015137</u>	Fuel Line, 3/16 (available by the foot)	1
4	<u>1016103</u>	Screw, Pan Hd Tx, Taptite 6-32	2
5	<u>1016438</u>	Gasket, Carb To Intake Manifold	1
6	<u>1016439</u>	Gasket, Insulator	1
7	<u>1016440</u>	Gasket, Engine to Insulator	1
8	<u>1016441</u>	Gasket, Sprg Brkt To Carb OHV	1
9	<u>1016444</u>	Bracket, Throttle Spring Return	1
10	1016480	Pipe, Intake Manifold	1
11	101648102	Insulator, Carburetor	1
12	<u>101649002</u>	Stud, M6-1.00 Two-Ended	2
13	1016547	Nut, M6 Flange	2
14	<u>1016572</u>	Tube, Crankcase Vent	1
15	<u>1016582</u>	Spring, Throttle Return	1
16	<u>1017466</u>	Clamp	2
17	101820201	Shield, Governor	1
18	<u>101887601</u>	Locknut, M6-1.00 Nylon Insert	1

10
G

CARBURETOR INSTALLATION – FE350

ITEM	PART NO.	DESCRIPTION	QTY
		1 2 3 4	
1	<u>1013746</u>	Clamp, 0.301 ID Hose	1
2	<u>1015137</u>	Fuel Line, 3/16 (available by the foot)	1
3	<u>1016438</u>	Gasket, Carb To Intake Manifold	1
4	<u>1016440</u>	Gasket, Engine to Insulator	1
5	<u>1016441</u>	Gasket, Sprg Brkt To Carb OHV	1
6	<u>1016444</u>	Bracket, Throttle Spring Return	1
7	1016480	Pipe, Intake Manifold	1
8	101648102	Insulator, Carburetor	1
9	<u>101649002</u>	Stud, M6-1.00 Two-Ended	2
10	1016547	Nut, M6 Flange	2
11	<u>1016572</u>	Tube, Crankcase Vent	1
12	<u>1016582</u>	Spring, Throttle Return	1
13	<u>1017466</u>	Clamp	2
14	<u>101973401</u>	Gasket, Insulator To Bracket	1

10
G

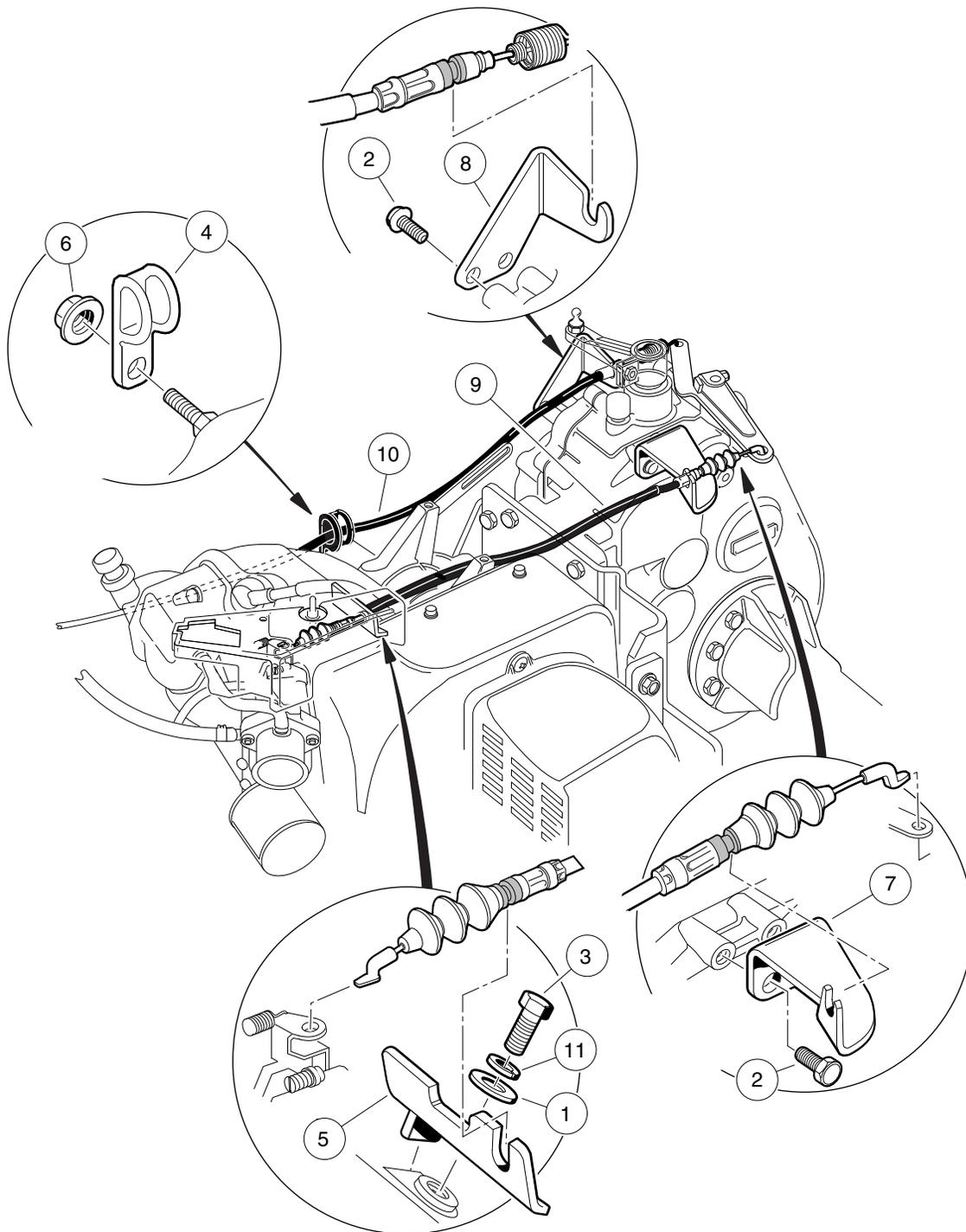

000215-001

GOVERNOR AND ACCELERATOR CABLES

ITEM	PART NO.	DESCRIPTION	QTY
		1 2 3 4	
1	<u>1011697</u>	Washer, 5/16 Flat	1
2	<u>1012285</u>	Screw, 1/4 X 0.625 Hex-Head	4
3	<u>1012830</u>	Screw, M8-125 X 22 Hex-Head	1
4	<u>1013700</u>	Clamp	2
5	<u>101584502</u>	Bracket, Governor Cable Snap-In	1
6	<u>1016546</u>	Nut	2
7	<u>101832202</u>	Bracket, Rear Governor Cable Snap-In	1
8	<u>101832302</u>	Bracket, Rear Accelerator Cable Snap-In	1
9	<u>102336001</u>	Cable, Governor, Snap-In	1
10	<u>102336101</u>	Cable, Accelerator, Snap-In	1
11	<u>7174</u>	Lockwasher, 5/16 Split	1

10
G

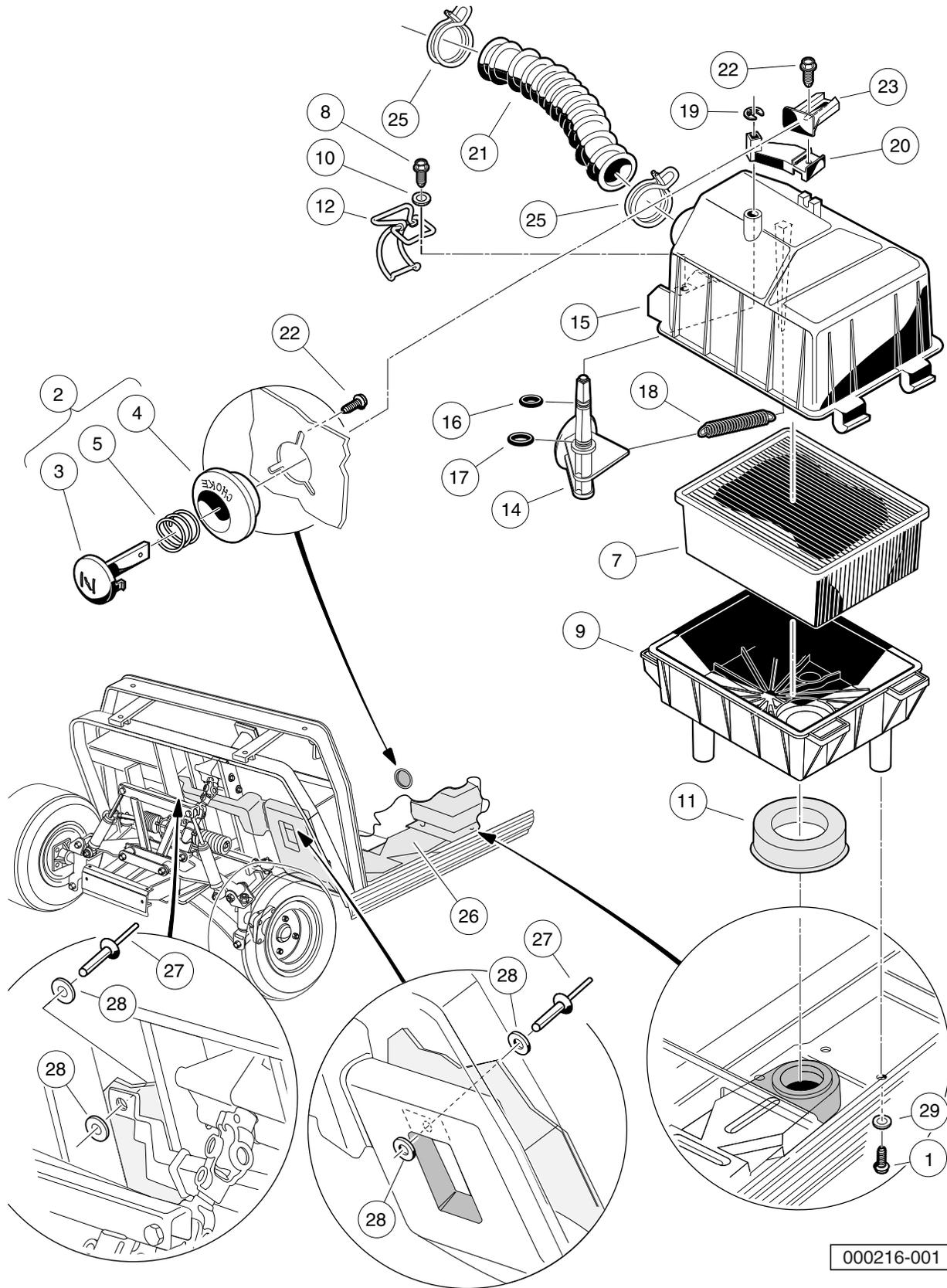

000216-001

INTAKE DUCT, CHOKE, AND AIR BOX ASSEMBLY

ITEM	PART NO.	DESCRIPTION	QTY
		1 2 3 4	
1	<u>1015752</u>	Screw, #12-16 X 0.625, Hi-Lo	3
2	<u>101805701</u>	Button Assembly, Choke (includes items 3 through 5)	1
3	<u>101811401</u>	Lever, Choke	1
4	<u>101811501</u>	Guide, Choke Lever	1
5	<u>101856201</u>	Compression Spring	1
6	<u>101821501</u>	Assembly, Air Box (includes items 7 through 13)	1
7	<u>1015426</u>	Filter, Air	1
8	<u>101804301</u>	Screw, #8 X 0.500, Hex-Head Hi-Lo	2
9	<u>101811901</u>	Bottom, Air Box	1
10	<u>101881701</u>	Washer, #8 Stainless-Steel Flat	2
11	<u>101921501</u>	Seal, Intake	1
12	<u>101925701</u>	Latch, Wireform	2
13	<u>101972801</u>	Top Assy, Air Box (includes items 14 through 20)	1
14	N/A	Valve, Choke	1
15	N/A	Top, Air Box	1
16	N/A	O-Ring, 5/16	1
17	N/A	O-Ring, 3/8	1
18	<u>101812301</u>	Spring, Extension Return	1
19	<u>101813001</u>	Retaining Ring 0.25, Shaft	1
20	<u>101917601</u>	Lever, Choke	1
21	<u>101837101</u>	Hose, Air Intake	1
22	<u>101850301</u>	Screw, #12-16 X 0.50 Washer-Head Hi-Lo	4
23	<u>101917701</u>	Choke Positioner	1
24	N/A	Tape Kit, Air Duct Repair	1
25	<u>101971301</u>	Clamp, 1.58" ID Hose	2
26	<u>103520301</u>	Duct, Air Intake, Ds	1
27	<u>1606</u>	Rivet, 3/16 X .500 Alum Pop	2
28	<u>183</u>	Washer, #10, Type A, Flat	4
29	<u>332</u>	Washer, 1/4 Type A Narrow Flat	3
		Note: Item 25 is not illustrated.	

10

G

10

G

EXHAUST SYSTEMS

11

G

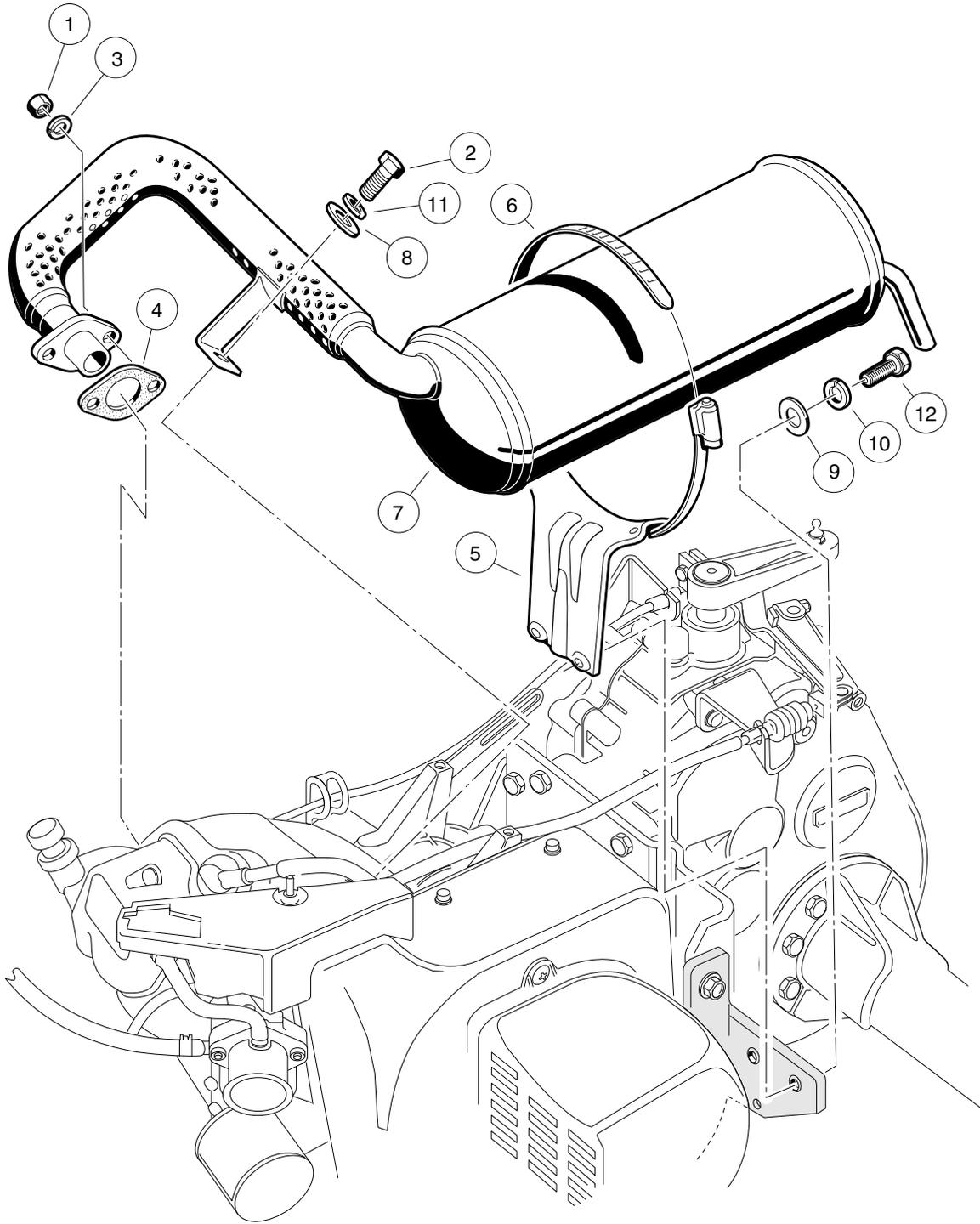

000208-001

EXHAUST SYSTEM – FE290 ENGINE

ITEM	PART NO.	DESCRIPTION	QTY
		1 2 3 4	
1	<u>1012528</u>	Nut, M8-1.25 Hex	2
2	<u>1012830</u>	Screw, M8-125 X 22 Hex-Head	1
3	<u>1013734</u>	Lockwasher, 8mm Split	2
4	<u>1015330</u>	Gasket, Exhaust	1
5	<u>1015814</u>	Bracket, Muffler Mounting	1
6	1017689	Clamp, 5" Muffler Hose	1
7	<u>101859301</u>	Exhaust System, FE290	1
8	<u>1241</u>	Washer, 5/16 Type A Flat	1
9	<u>332</u>	Washer, 1/4 Type A Narrow Flat	2
10	<u>451</u>	Lockwasher, 1/4 Split	2
11	<u>7174</u>	Lockwasher, 5/16 Split	1
12	<u>7847</u>	Screw, 1/4-20 X 0.75 Hex-Head Cap	2

11
G

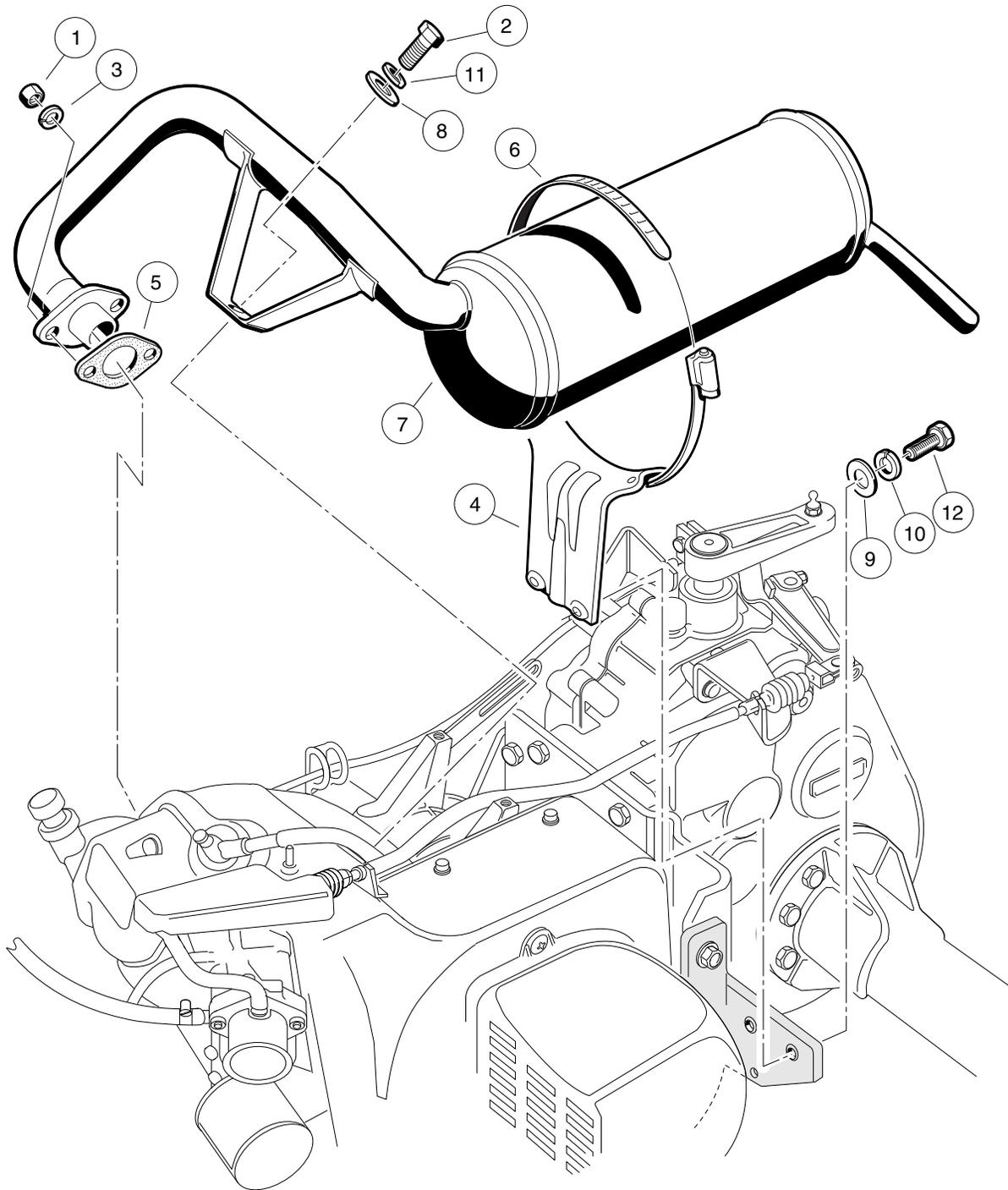

000209-001

EXHAUST SYSTEM – FE350 ENGINE

ITEM	PART NO.	DESCRIPTION	QTY
		1 2 3 4	
1	<u>1012528</u>	Nut, M8-1.25 Hex	2
2	<u>1012830</u>	Screw, M8-125 X 22 Hex-Head	1
3	<u>1013734</u>	Lockwasher, 8mm Split	2
4	<u>1015814</u>	Bracket, Muffler Mounting	1
5	<u>1016904</u>	Gasket, Exhaust	1
6	1017689	Clamp, 5" Muffler Hose	1
7	<u>101859401</u>	Exhaust System, FE350	1
8	<u>1241</u>	Washer, 5/16 Type A Flat	1
9	<u>332</u>	Washer, 1/4 Type A Narrow Flat	2
10	<u>451</u>	Lockwasher, 1/4 Split	2
11	<u>7174</u>	Lockwasher, 5/16 Split	1
12	<u>7847</u>	Screw, 1/4-20 X 0.75 Hex-Head Cap	2

11
G

11

G

TORQUE CONVERTER

12

G

12
G

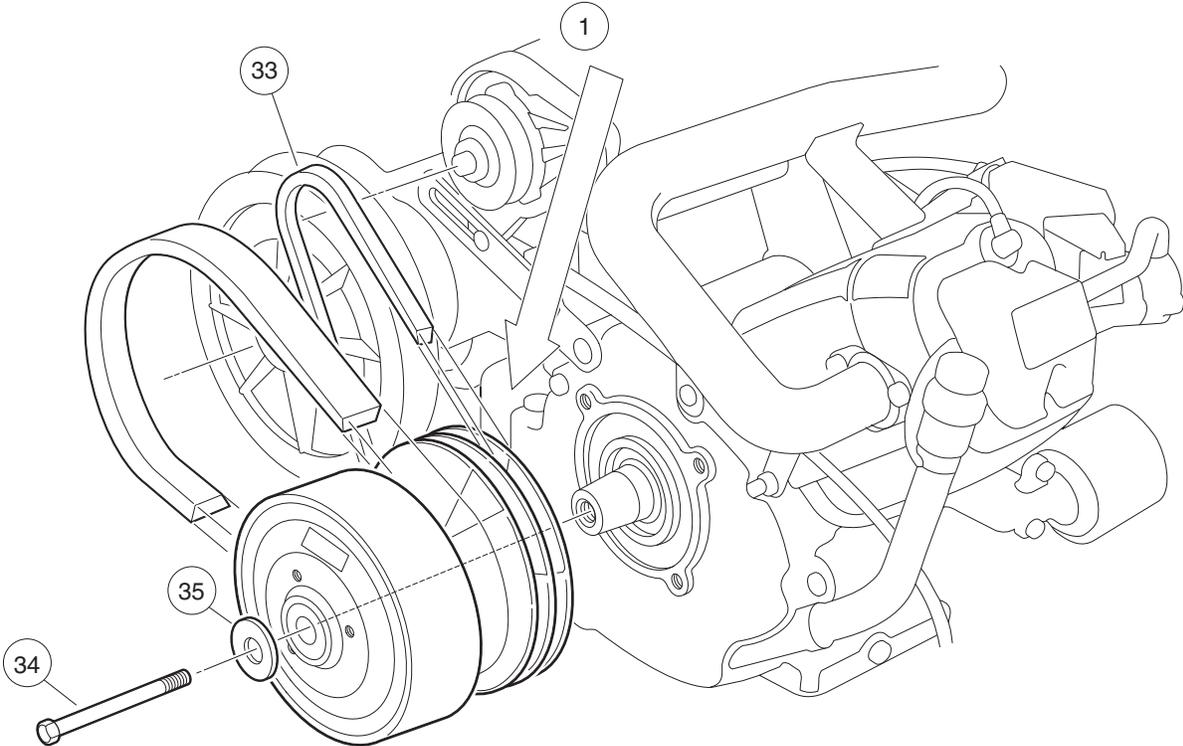
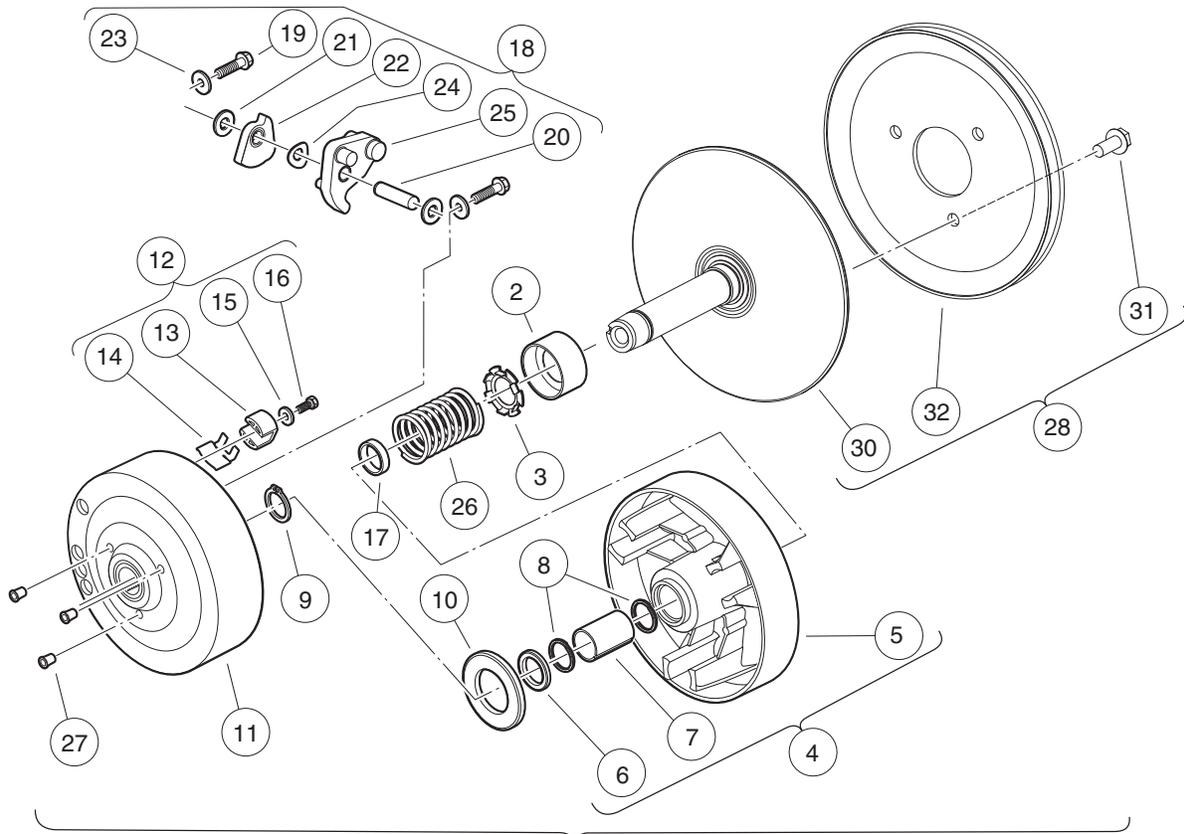

000217-009

DRIVE CLUTCH

12

G

ITEM	PART NO.	DESCRIPTION	QTY
		1 2 3 4	
1	<u>101833906</u>	Drive Clutch Assy. FE 350/272 (includes items 2 through 28)	1
2	1014049	Bearing, Idler	1
3	<u>1014050</u>	Retainer, Spring	1
4	1014052	Movable-Face Assembly (includes items 5 through 7)	1
5	N/A	Drive Clutch Movable Face	1
6	<u>1014055</u>	Retainer	1
7	N/A	Bushing, Split, Drive Clutch	1
8	<u>1014056</u>	Ring, Spiral Backup	2
9	<u>1014057</u>	Ring, 0.810" Internal Retaining	1
10	1014058	Thrust Washer	1
11	1014059	Drive Hub Assy, Drive Clutch	1
12	<u>1014453</u>	Kit, Drive Clutch Button (includes items 13 through 16)	1
13	<u>1014062</u>	Driver, Drive Clutch	3
14	<u>1014287</u>	Spring, Drive Button	3
15	<u>183</u>	Washer, #10, Type A, Flat	3
16	<u>8450</u>	Screw, #10-24 X 0.50, Hex-Head	3
17	<u>1016289</u>	Spacer, Fixed Face Shaft	1
18	<u>1016801</u>	Kit, Drive Clutch Weight (includes items 19 through 25)	1
19	<u>1014063</u>	Screw, 1/4-20 X 1.00, Hex Head	6
20	N/A	Pin, Dowel, 0.3752 x 1.50	3
21	<u>1014065</u>	Washer, Flat, 0.38" ID, Delrin	6
22	N/A	Clutch Weight, Secondary	3
23	N/A	Washer	6
24	<u>1016201</u>	Washer, Wave	3
25	N/A	Weight, Primary	3
26	<u>1016901</u>	Spring, Drive Clutch	1
27	N/A	Cap Plug	3
28	<u>101929802</u>	Kit, Fxd Face Dr Asm Fe290/350 (includes item 29)	1
29	N/A	Assembly, Fixed-Face Drive (includes items 30 through 32)	1
30	N/A	Fixed Face Assembly, Drive Clutch	1
31	<u>1014288</u>	Screw, 5/16-18 X 0.75, Thread-Forming	3
32	N/A	Pulley, Clutch	1
33	<u>101916701</u>	V-Belt	1
34	<u>103345701</u>	Screw 3/8-24x5.5 Hex Loc Ptch	1
35	<u>808</u>	Washer, 3/8 Type B Flat	1
		Note: Item 29 not shown.	

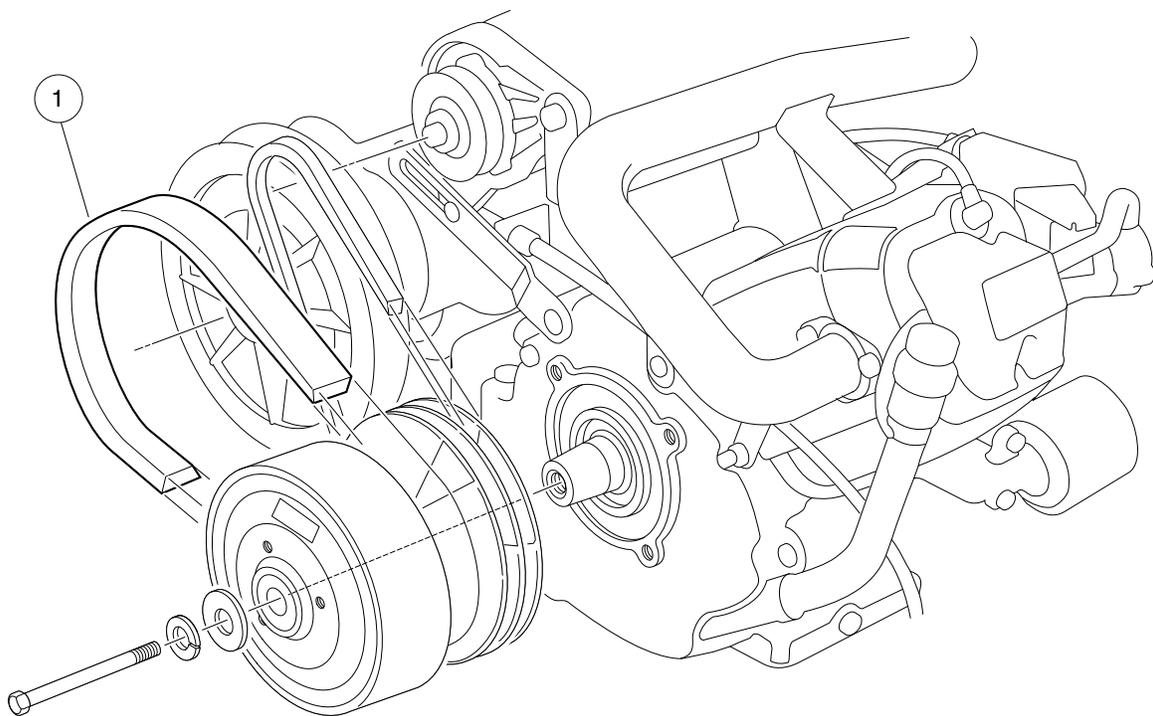

000218-001

DRIVE BELT – FE290

ITEM	PART NO.	DESCRIPTION	QTY
1	<u>1016203</u>	<div style="display: flex; justify-content: space-between; margin-bottom: 5px;"> 1 2 3 4 </div> Belt, Drive	1

12

G

12

G

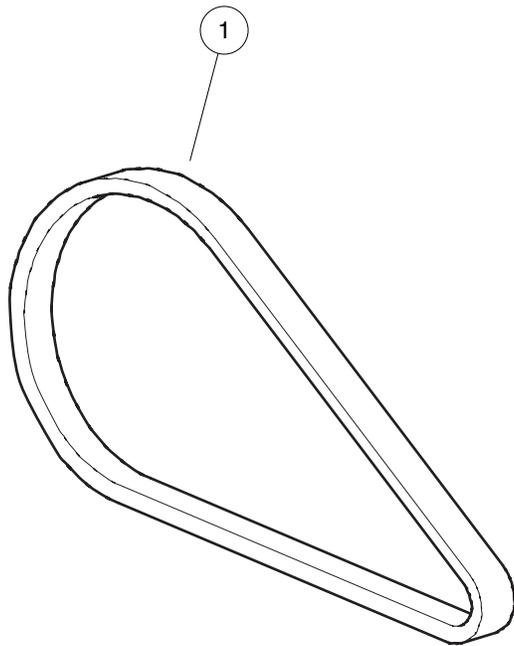

000918-001

DRIVE BELT

ITEM	PART NO.	DESCRIPTION	QTY
1	<u>1017188</u>	1 2 3 4 Belt, Drive (FE350)	1

12
G

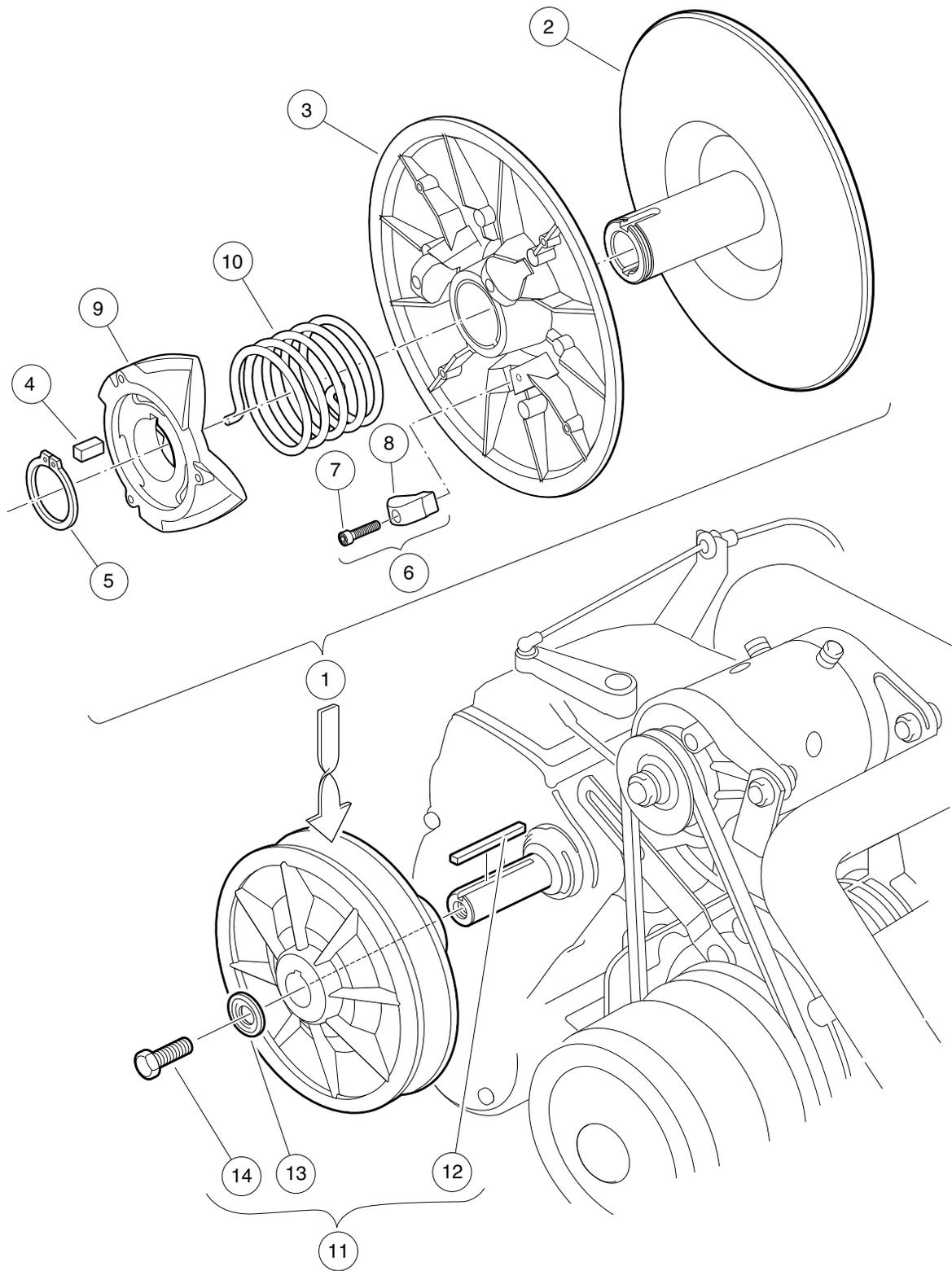

000219-001

DRIVEN CLUTCH

ITEM	PART NO.	DESCRIPTION	QTY
		1 2 3 4	
1	<u>101834001</u>	Assembly, Driven Clutch (includes items 2 through 10)	1
2	<u>1014070</u>	Fixed Face Assy, Driven Clutch	1
3	<u>1014072</u>	Movable-Face Assembly with Bushing	1
4	<u>1014078</u>	Key, Driven Clutch	1
5	<u>1014080</u>	Ring, Retaining	1
6	<u>1014454</u>	Kit, Driven Clutch Button (includes items 7 and 8)	1
7	<u>1012836</u>	Screw, #8-32 X 3/4, Socket-Head Cap	3
8	N/A	Button, Drive	3
9	<u>1017686</u>	Cam, Driven Clutch	1
10	<u>101836201</u>	Spring, Driven Clutch, Reversed	1
11	<u>AM10419</u>	Kit, Clutch Repair (includes items 12 through 14)	1
12	<u>101833401</u>	Key, 3/16 Sq X 1.50"	1
13	<u>102155801</u>	Washer, Driven Clutch	1
14	<u>102242101</u>	Screw, 5/16-18 X 3/4 Hex-Head with Patch	1

12
G

12

G

TRANSAXLE AND FNR SHIFTER- GASOLINE VEHICLE

13

G

FORWARD/REVERSE SHIFTER ASSEMBLY – GASOLINE-VEHICLES

ITEM	PART NO.	DESCRIPTION	QTY
		1 2 3 4	
1	<u>1012987</u>	Handle, FNR	1
2	<u>1015064</u>	Screw, #8-32 X 0.63 Machine	1
3	<u>1016201</u>	Washer, Wave	1
4	<u>1016947</u>	Assembly, FNR Shifter (includes items 5 through 22)	1
5	<u>1010954</u>	Stud, Ball, 1/4-28 X 0.560	1
6	<u>1012431</u>	Washer, #4 Flat	4
7	<u>1012594</u>	Screw, #4-40 Machine	2
8	<u>1013587</u>	FNR Bell Crank Weldment	1
9	<u>1013589</u>	Ring, Retaining, 0.338" Internal	1
10	<u>1013590</u>	Spring, FNR Cam	1
11	<u>1013591</u>	Pin, Roll, 1/8 X 1/2	1
12	<u>1014089</u>	Neutral Lockout Cam Kit (includes items 13 and 14)	1
13	N/A	Cam, Neutral Lockout	1
14	<u>1014065</u>	Washer, Flat, 0.38" ID, Delrin	1
15	<u>1014145</u>	Bushing, Secondary Weight, Split	2
16	<u>1014727</u>	Washer, Flat, #4, Nylon	2
17	<u>1014807</u>	Switch, Limit	1
18	<u>1016342</u>	FNR Shifter Base	1
19	<u>101979101</u>	Switch, Limit, Assembly, Sealed	1
20	<u>8057</u>	Nut, #4-40 Hex Machine	4
21	<u>8058</u>	Lockwasher, #4 Split	2
22	<u>8717</u>	Locknut, Nylon Insert, 1/4-28	1
23	<u>8233</u>	Locknut, 1/4-20, Nylon Insert	4
24	<u>8248</u>	Screw, 1/4-20 X 0.75, Truss-Head Machine	4

13

G

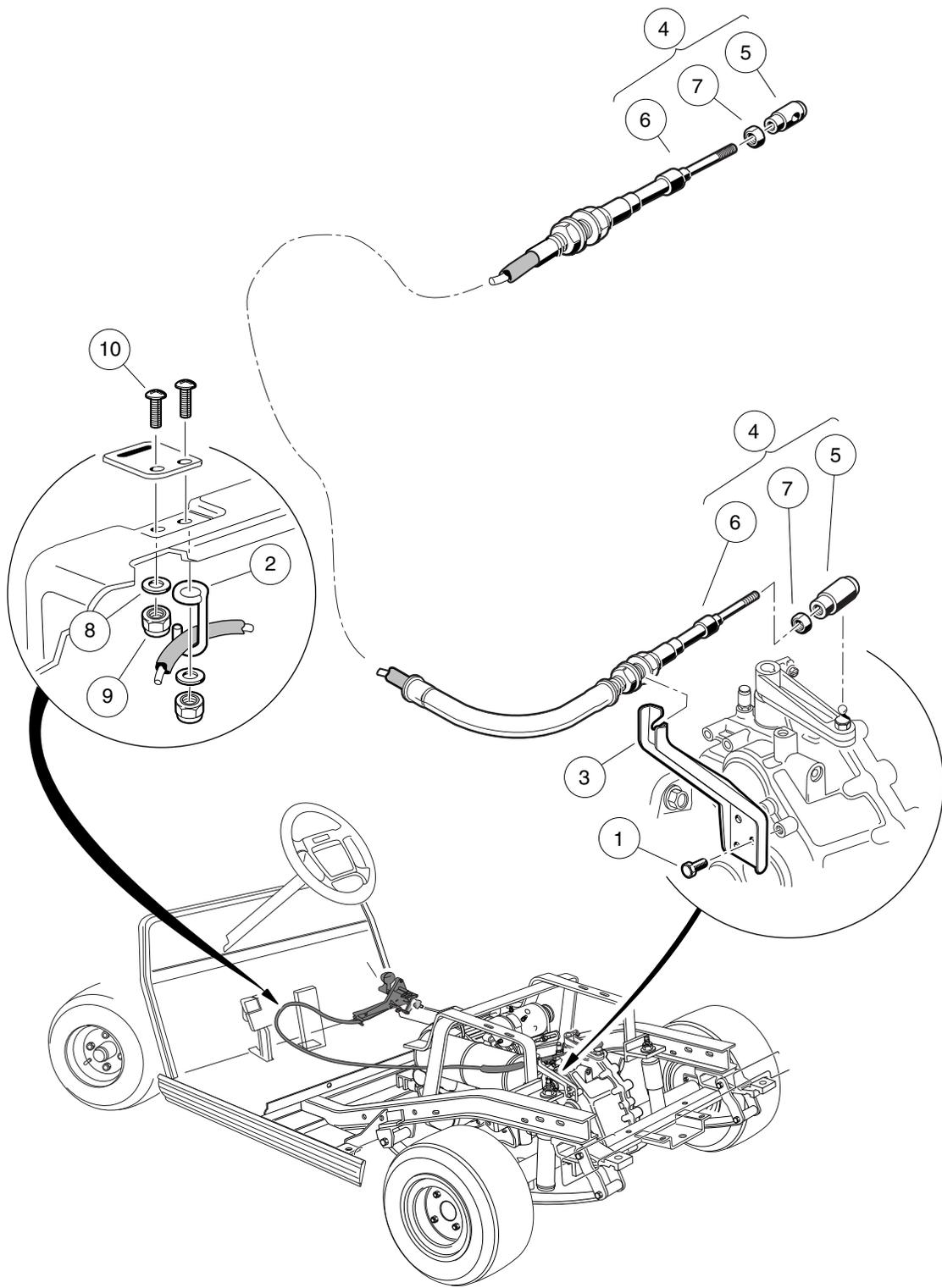

000248-001

FORWARD/REVERSE SHIFTER CABLE – GASOLINE VEHICLES

ITEM	PART NO.	DESCRIPTION	QTY
		1 2 3 4	
1	<u>1012285</u>	Screw, 1/4 X 0.625 Hex-Head	3
2	<u>101855801</u>	Cable Retainer	1
3	<u>101922601</u>	Bracket, Shifter	1
4	<u>101951501</u>	FNR Shifter Cable (includes items 5 through 7)	1
5	<u>1012333</u>	Joint, #10-32 Ball	2
6	<u>103379501</u>	Cable, Transmission Shifter Ds	1
7	<u>7893</u>	Nut, #10-32 Hex	2
8	<u>332</u>	Washer, 1/4 Type A Narrow Flat	4
9	<u>8233</u>	Locknut, 1/4-20, Nylon Insert	4
10	<u>8251</u>	Screw, 1/4-20 X 1.0 Truss-Head Machine	4

13

G

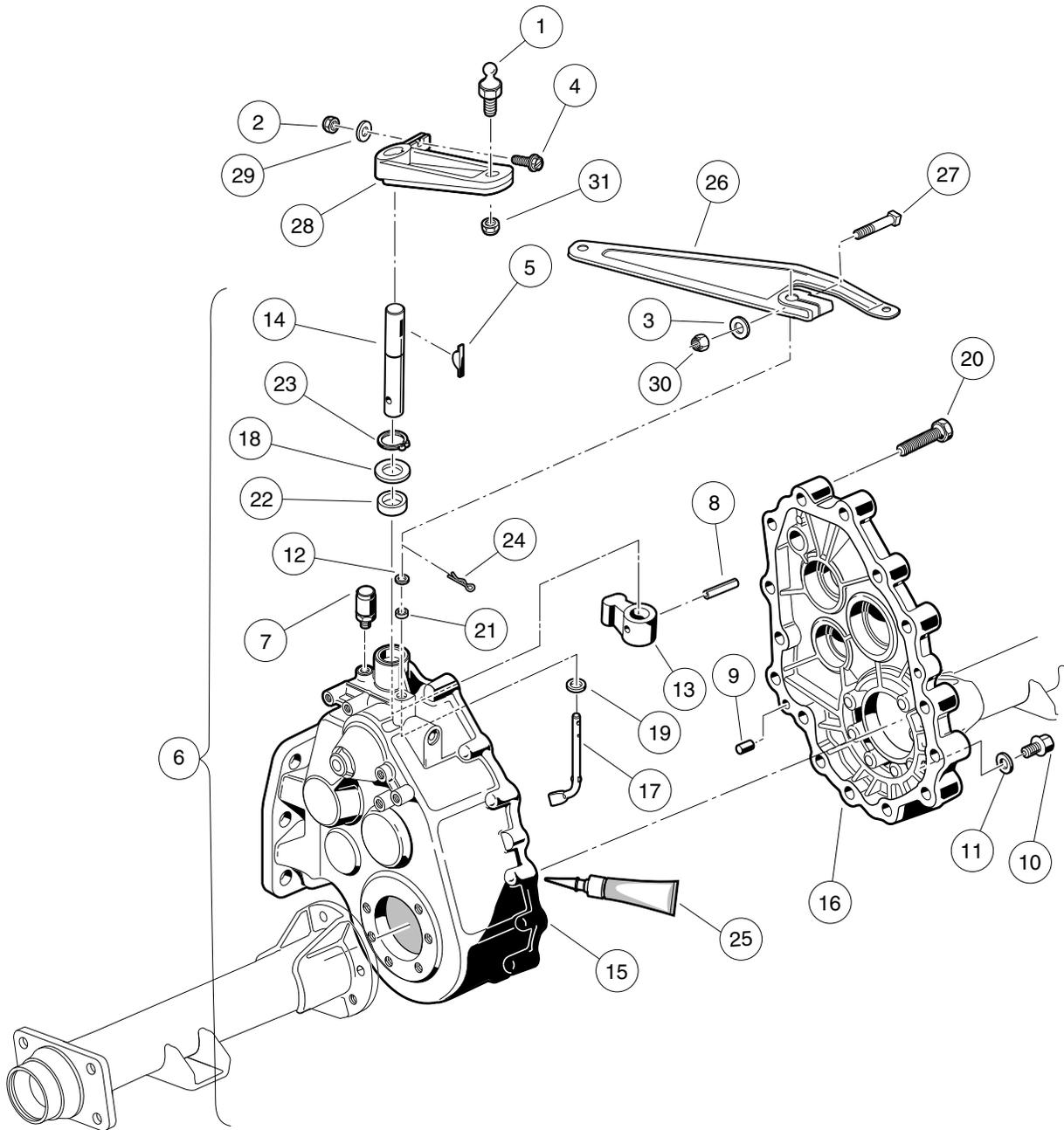

000220-005

KAWASAKI TRANSAXLE – GEAR CASES AND BRACKETS

13

G

ITEM	PART NO.	DESCRIPTION	QTY
		1 2 3 4	
1	<u>1010954</u>	Stud, Ball, 1/4-28 X 0.560	1
2	<u>1013061</u>	Locknut, #10-32 Nylon Insert	1
3	<u>1014007</u>	Washer, 1/4, Flat	1
4	<u>1017082</u>	Screw, #10-32 X 0.75, Hex-Head Machine	1
5	<u>1017231</u>	Key, Woodruff	1
6	<u>101833601</u>	Transaxle, 11.77 Ratio (includes items 7 through 25)	1
7	<u>1012711</u>	Breather	1
8	<u>1012752</u>	Roll Pin	1
9	<u>1012896</u>	Pin, Dowel	2
10	<u>1013760</u>	Fill Plug	2
11	<u>1016432</u>	Gasket, Drain Plug	1
12	<u>1016513</u>	Washer, M6 Flat	1
13	<u>101890101</u>	Lever, Drive Selector	1
14	<u>101890201</u>	Shaft, Drive Selector	1
15	<u>101890501</u>	Gear Case (driver side)	1
16	<u>101890601</u>	Gear Case (passenger side)	1
17	<u>101891301</u>	Arm Pivot	1
18	<u>101892901</u>	Washer	1
19	<u>101893801</u>	Washer	1
20	<u>101926901</u>	Screw, M8-1.25 X 40mm Hex-Head	15
21	<u>101927101</u>	Seal, Oil	1
22	<u>101927201</u>	Seal, Oil	1
23	<u>101927301</u>	Snap Ring	1
24	<u>101928601</u>	Pin, Cotter	1
25	<u>101928701</u>	Liquid Gasket (Transaxle case)	1
26	<u>101834801</u>	Arm, Governor	1
27	<u>101886101</u>	Screw, 1/4-20 X 1.00, Square-Head	1
28	<u>102515401</u>	Lever, Transmission Shift	1
29	<u>183</u>	Washer, #10, Type A, Flat	1
30	<u>8233</u>	Locknut, 1/4-20, Nylon Insert	1
31	<u>8717</u>	Locknut, Nylon Insert, 1/4-28	1
<p>Note: Kawasaki transaxle component listings span three pages. To identify your transaxle, locate the serial number decal on the axle tube.</p>			

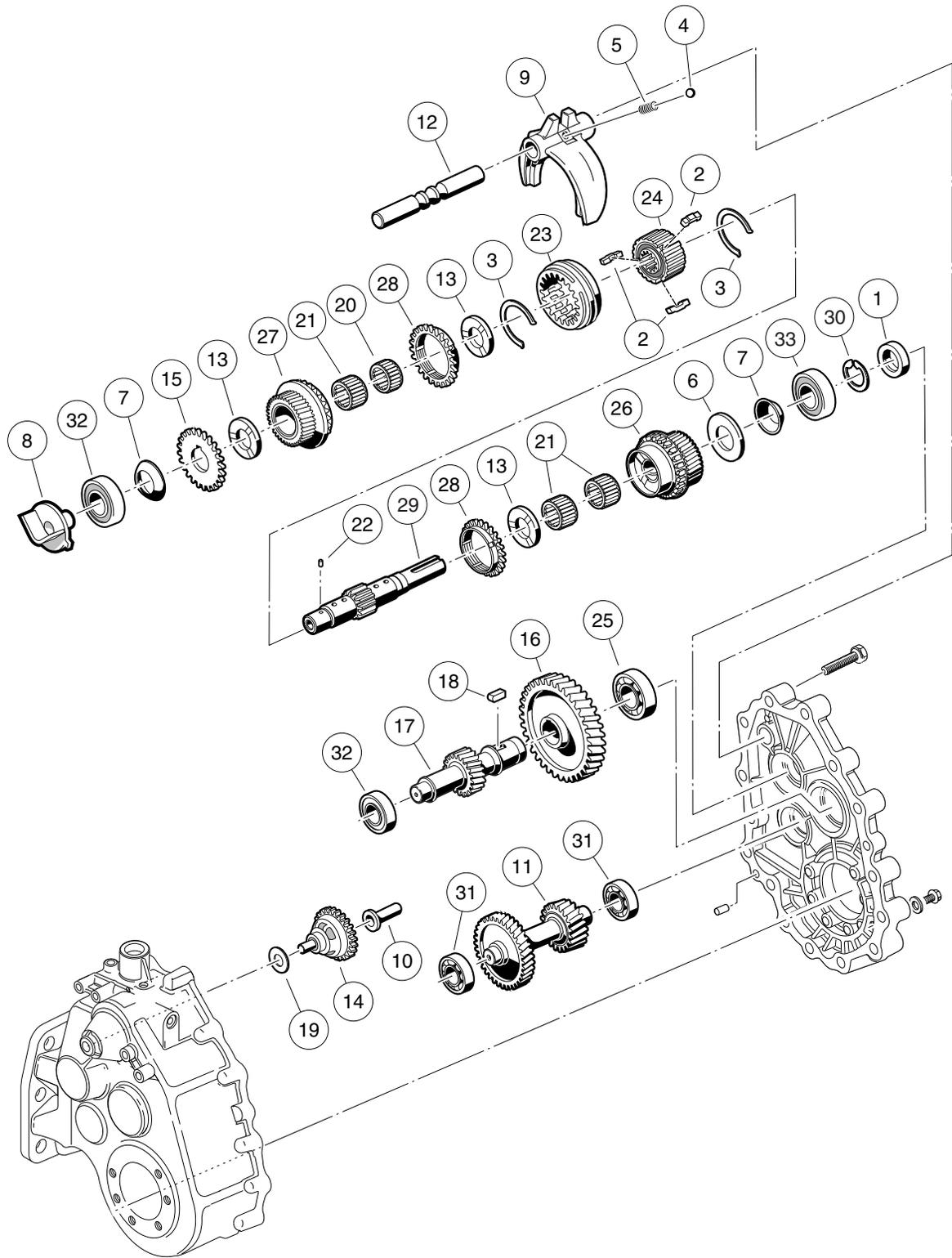

000221-001

KAWASAKI TRANSAXLE – F&R TRANSMISSION AND GEAR REDUCTION

13

G

ITEM	PART NO.	DESCRIPTION	QTY
		1 2 3 4	
1	<u>1012714</u>	Oil Seal	1
2	<u>1012740</u>	Synchro Insert	3
3	<u>1012741</u>	Synchro Spring	2
4	<u>1012747</u>	Shifter Ball	1
5	<u>1012748</u>	Shifter Spring	1
6	<u>1016337</u>	Washer, Thrust	1
7	<u>1016338</u>	Washer, Spring	2
8	<u>101889401</u>	Guide	1
9	<u>101890001</u>	Fork - Shift	1
10	<u>101891601</u>	Sleeve, Governor	1
11	<u>101891901</u>	Gear, Cluster	1
12	<u>101892001</u>	Rod, Shift	1
13	<u>101892201</u>	Plate, Thrust	3
14	<u>101892301</u>	Governor Assembly	1
15	<u>101892401</u>	Gear, Spur	1
16	<u>101892501</u>	Gear, Helical (61 Tooth)	1
17	<u>101892601</u>	Gear, Helical (17 Tooth)	1
18	<u>101893201</u>	Key Sunk	1
19	<u>101893901</u>	Washer	1
20	<u>101927501</u>	Needle Bearing	1
21	<u>101927601</u>	Needle Bearing	3
22	<u>101927701</u>	Pin, .116" Dia X 0.264 Dowel	1
23	<u>101927901</u>	Sleeve, Synchro	1
24	<u>101928001</u>	Hub, Synchro Clutch	1
25	<u>101928101</u>	Bearing, Ball	1
26	<u>101980801</u>	Gear Assembly, 16-Degree Synchro (25 Tooth)	1
27	<u>101980901</u>	Gear Assembly, 16-Degree Rear Synchro (28 Tooth)	1
28	<u>101981001</u>	Ring, 16-Degree Synchronizer	2
29	<u>102453001</u>	Shaft, Trans, with Circlip	1
30	<u>102453101</u>	Circlip	1
31	<u>7335</u>	Bearing	2
32	<u>AM10080</u>	Bearing, Ball, Sealed	2
33	<u>AM10081</u>	Bearing, Ball, Sealed	1
<p>Note: To identify your transaxle, locate the serial number decal on the axle</p>			

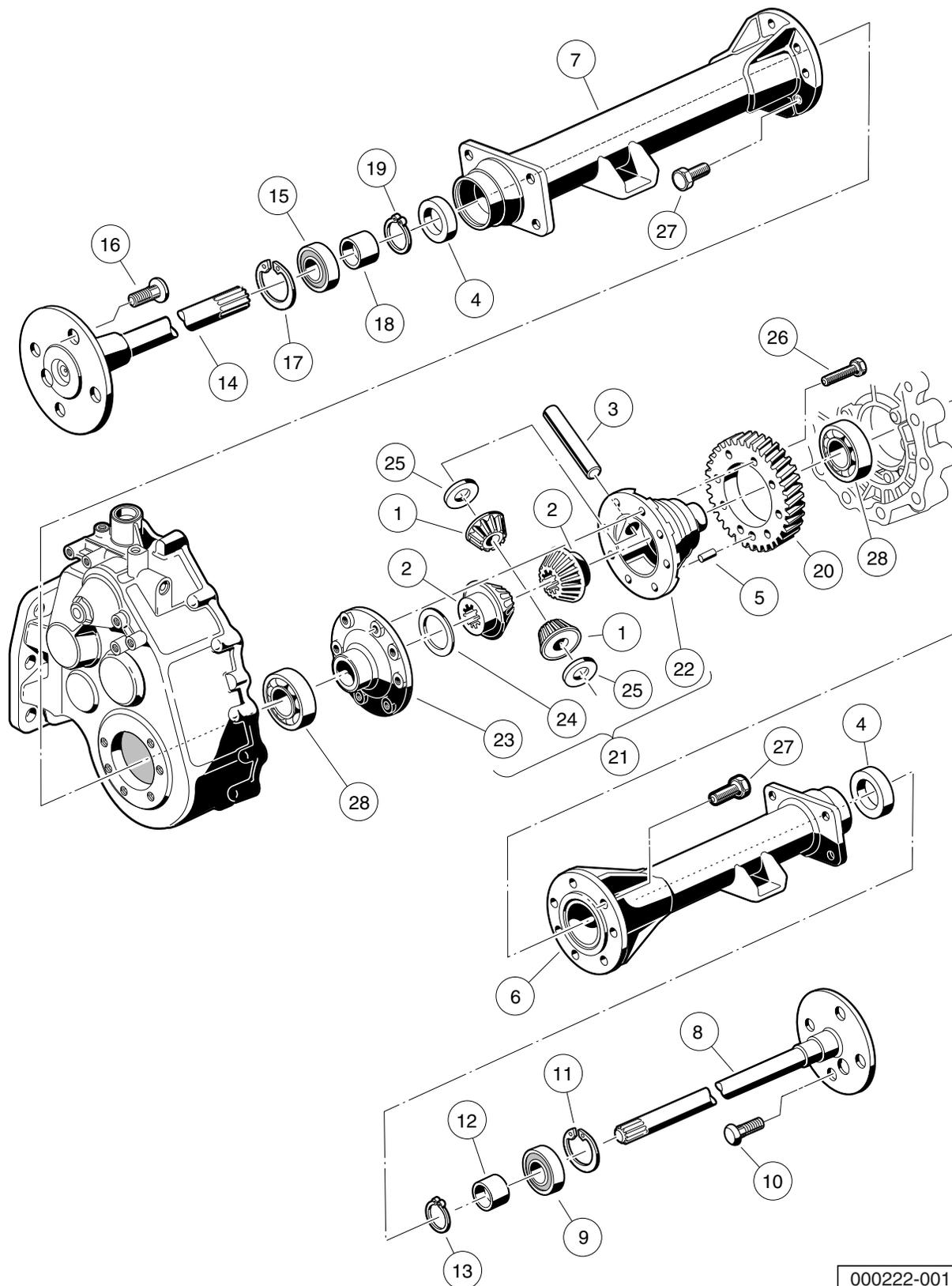

000222-001

KAWASAKI TRANSAXLE – DIFFERENTIAL AND AXLES

ITEM	PART NO.	DESCRIPTION	QTY
		1 2 3 4	
1	<u>1013770</u>	Differential Idler Gear	2
2	<u>1013771</u>	Gear, Differential	2
3	<u>1013772</u>	Pin, Differential	1
4	<u>1013794</u>	Axle Shaft Oil Seal	2
5	N/A	Dowel Pin	1
6	<u>101890901</u>	Axle Tube (Passenger Side)	1
7	<u>101891001</u>	Axle Tube (Driver Side)	1
8	<u>101891401</u>	Axle Assembly, Passenger Side (includes items 9 through 13)	1
9	<u>1011291</u>	Outer Axle, Tube Bearing	1
10	<u>1013787</u>	Lug Stud	4
11	<u>1013792</u>	Circlip Type C	1
12	<u>1014207</u>	Bushing	1
13	<u>1016672</u>	Retaining Ring	1
14	<u>101891501</u>	Axle Assembly, Driver-Side (includes items 15 through 19)	1
15	<u>1011291</u>	Outer Axle, Tube Bearing	1
16	<u>1013787</u>	Lug Stud	4
17	<u>1013792</u>	Circlip Type C	1
18	<u>1014207</u>	Bushing	1
19	<u>1016672</u>	Retaining Ring	1
20	<u>101892701</u>	Gear, Helical	1
21	<u>101910501</u>	Kit, Differential Gear Case (includes items 22 through 25)	1
22	<u>1013768</u>	Differential Gear Case, Left-Hand	1
23	<u>1013769</u>	Differential Gear Case, Right-Hand	1
24	<u>1013773</u>	Plate, Thrust (Differential Gear)	1
25	<u>1013774</u>	Plate, Thrust (Idler Gear)	2
26	<u>101928301</u>	Screw, M8-1.25 X 35mm Hex Head	8
27	<u>102031901</u>	Bolt, M10 X 1.5 X 30mm	14
28	<u>7330</u>	Inner Axle Tube Bearing	2
Note: To identify your transaxle, locate the serial number decal on the axle			

13

G

13
G

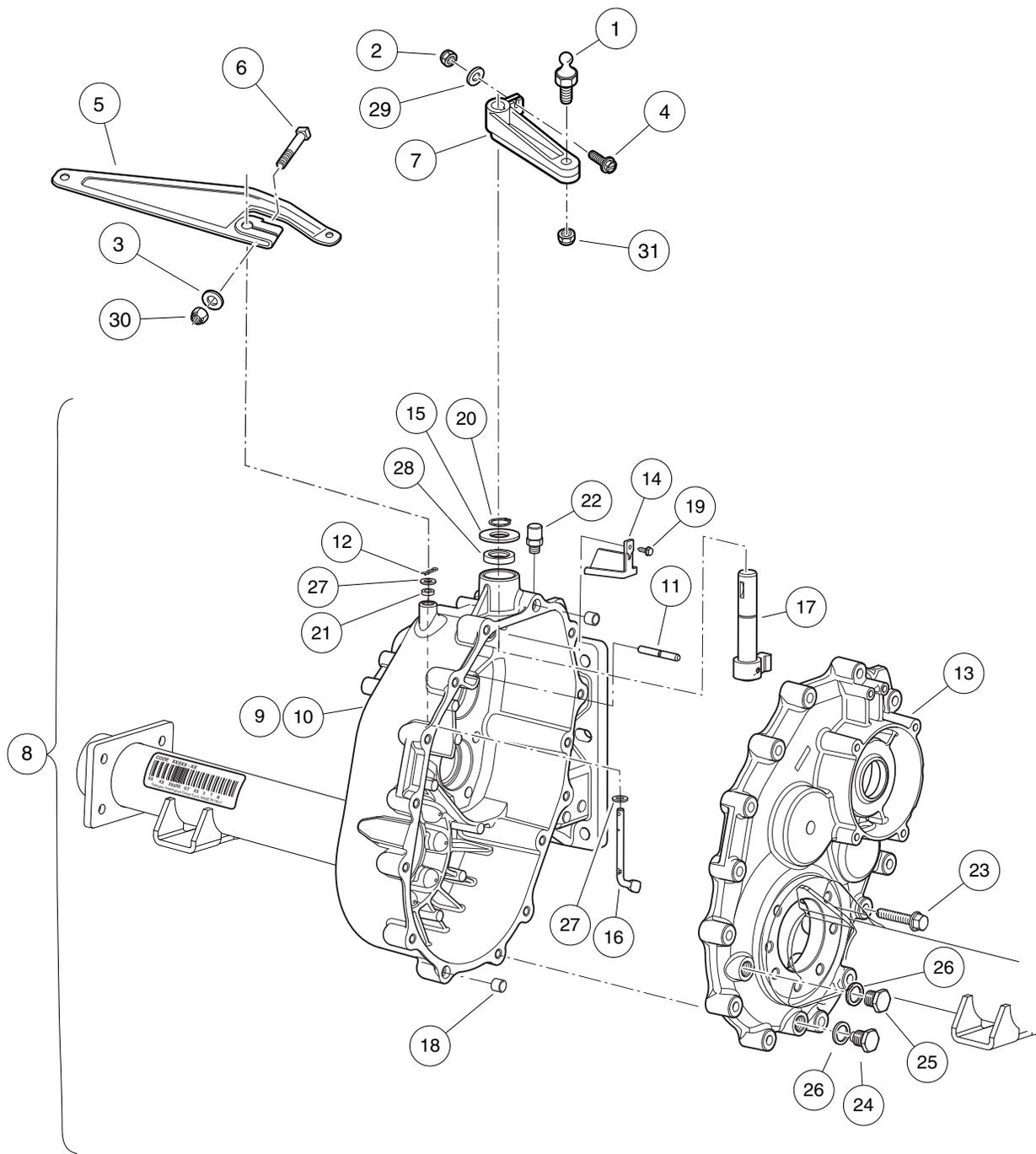

000680-009

GRAZIANO TRANSAXLE – GEAR CASES AND LEVERS

ITEM	PART NO.	DESCRIPTION	QTY
		1 2 3 4	
1	<u>1010954</u>	Stud, Ball, 1/4-28 X 0.560	1
2	<u>1013061</u>	Locknut, #10-32 Nylon Insert	1
3	<u>1014007</u>	Washer, 1/4, Flat	1
4	<u>1017082</u>	Screw, #10-32 X 0.75, Hex-Head Machine	1
5	<u>101834801</u>	Arm, Governor	1
6	<u>101886101</u>	Screw, 1/4-20 X 1.00, Square-Head	1
7	<u>102515401</u>	Lever, Transmission Shift	1
8	<u>102896801</u>	Transaxle, Unitized, Graziano (includes items 9 through 28)	1
9	<u>102896901</u>	Gear Box (Driver-Side) (includes items 10 and 11)	1
10	N/A	Gear Box	1
11	N/A	Pin, Speed Governor	1
12	<u>102897401</u>	Pin, Split	1
13	<u>102897501</u>	Cover, Gear Box (Passenger-Side)	1
14	<u>102897601</u>	Conveyor, Oil	1
15	<u>102897801</u>	Washer, Thrust	1
16	<u>102897901</u>	Lever, Speed Governor	1
17	<u>102898201</u>	Unit, Drive Selector	1
18	<u>102899101</u>	Dowel	2
19	<u>102899201</u>	Screw	1
20	<u>102899401</u>	Ring, Snap	1
21	<u>102899701</u>	Grommet	1
22	<u>102899801</u>	Breather	1
23	<u>102900001</u>	Screw	15
24	<u>102900101</u>	Drain Plug, Magnetic	1
25	<u>102900201</u>	Fill Plug	1
26	<u>102900301</u>	Seal	2
27	<u>102900601</u>	Washer	2
28	<u>102900901</u>	Grommet	1
29	<u>183</u>	Washer, #10, Type A, Flat	1
30	<u>8233</u>	Locknut, 1/4-20, Nylon Insert	1
31	<u>8717</u>	Locknut, Nylon Insert, 1/4-28	1
		<p>Note: Graziano transaxle component listings span three pages. To identify your transaxle, locate the serial number decal on the axle tube.</p>	

13

G

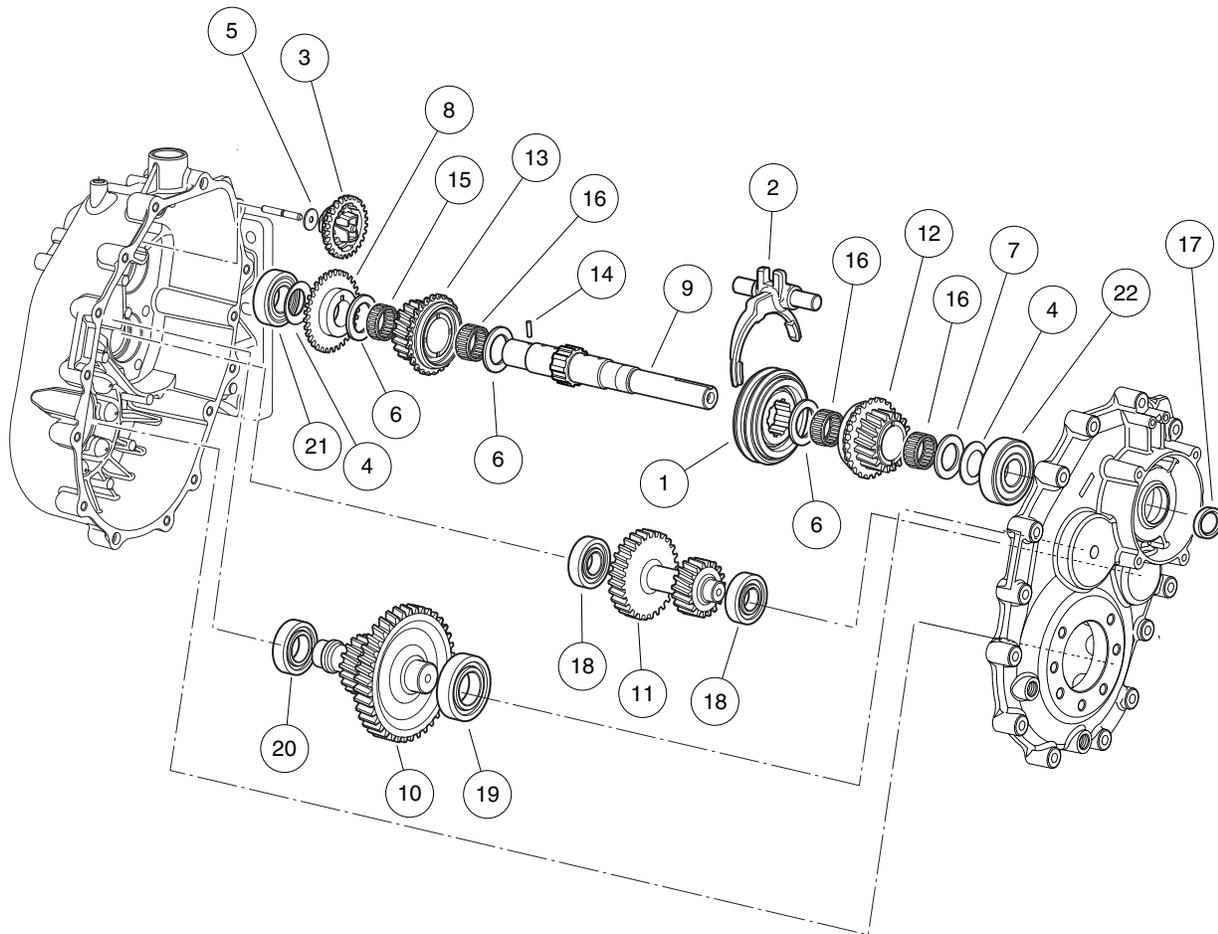

000680-006

GRAZIANO TRANSAXLE – F&R TRANSMISSION AND GEAR REDUCTION

13

G

ITEM	PART NO.	DESCRIPTION	QTY
		1 2 3 4	
1	<u>102897201</u>	Synchronizer, Complete	1
2	<u>102897301</u>	Fork, Complete	1
3	<u>102897701</u>	Assembly, Speed Governor	1
4	<u>102898001</u>	Washer, Belleville	2
5	<u>102898101</u>	Bearing, Thrust	1
6	<u>102898301</u>	Bearing, Thrust	3
7	<u>102898401</u>	Washer, Thrust	1
8	<u>102898501</u>	Gear, Speed Governor	1
9	<u>102898601</u>	Shaft, Main	1
10	<u>102898701</u>	Shaft, Secondary	1
11	<u>102898801</u>	Shaft, Reverse Gear	1
12	<u>102898901</u>	Gear, Complete, 25t	1
13	<u>102899001</u>	Gear, Complete, 28t	1
14	<u>102899301</u>	Pin	1
15	<u>102899501</u>	Cage, Roller	1
16	<u>102899601</u>	Cage, Roller	3
17	<u>102899901</u>	Grommet	1
18	<u>102900401</u>	Bearing	2
19	<u>102900501</u>	Bearing, 62 Od X 30 Id X 16	1
20	<u>102900701</u>	Bearing	1
21	<u>102901001</u>	Bearing	1
22	<u>102901101</u>	Bearing	1
<p>Note: To identify your transaxle, locate the serial number decal on the axle tube.</p>			

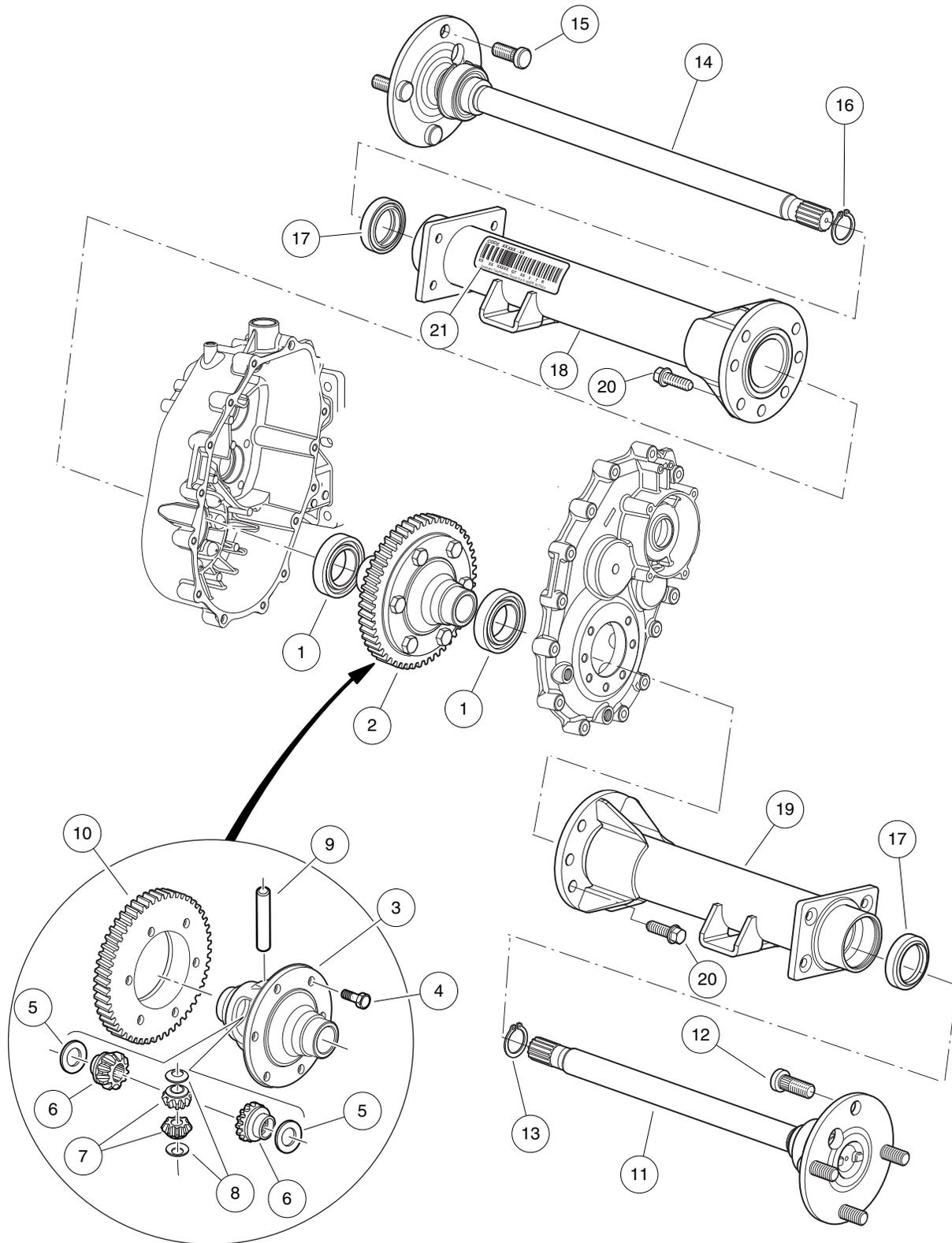

000681-002

GRAZIANO TRANSAXLE -DIFFERENTIAL AND AXLES

ITEM	PART NO.	DESCRIPTION	QTY
		1 2 3 4	
1	<u>102900801</u>	Bearing, 68 Od X 40 Id X 15	2
2	<u>102902001</u>	Assembly, Differential (includes items 3 through 10)	1
3	<u>102901201</u>	Box, Differential	1
4	<u>102901301</u>	Screw, M10 X 25	6
5	<u>102901401</u>	Ring, Sleeve	2
6	<u>102901501</u>	Gear, Sun	2
7	<u>102901601</u>	Gear, Planetary	2
8	<u>102901701</u>	Ring, Sleeve	2
9	<u>102901801</u>	Pin	1
10	<u>102901901</u>	Gear	1
11	<u>102902101</u>	Shaft, Axle, Short, Complete (Passenger-Side) (includes items 12 and 13)	1
12	<u>102902301</u>	Bolt, Stud	4
13	<u>102902401</u>	Snap Ring	1
14	<u>102902201</u>	Shaft, Axle, Long, Complete (Driver-Side) (includes items 15 and 16)	1
15	<u>102902301</u>	Bolt, Stud	4
16	<u>102902401</u>	Snap Ring	1
17	<u>102902501</u>	Seal, Lip	2
18	<u>102902601</u>	Axle Tube, (Driver-Side)	1
19	<u>102902701</u>	Axle Tube, (Passenger-Side)	1
20	<u>102902801</u>	Screw, M10 X 30	14
21	N/A	Tag, Serial	1
<p>Note: To identify your transaxle, locate the serial number decal on the axle tube.</p>			

13

G

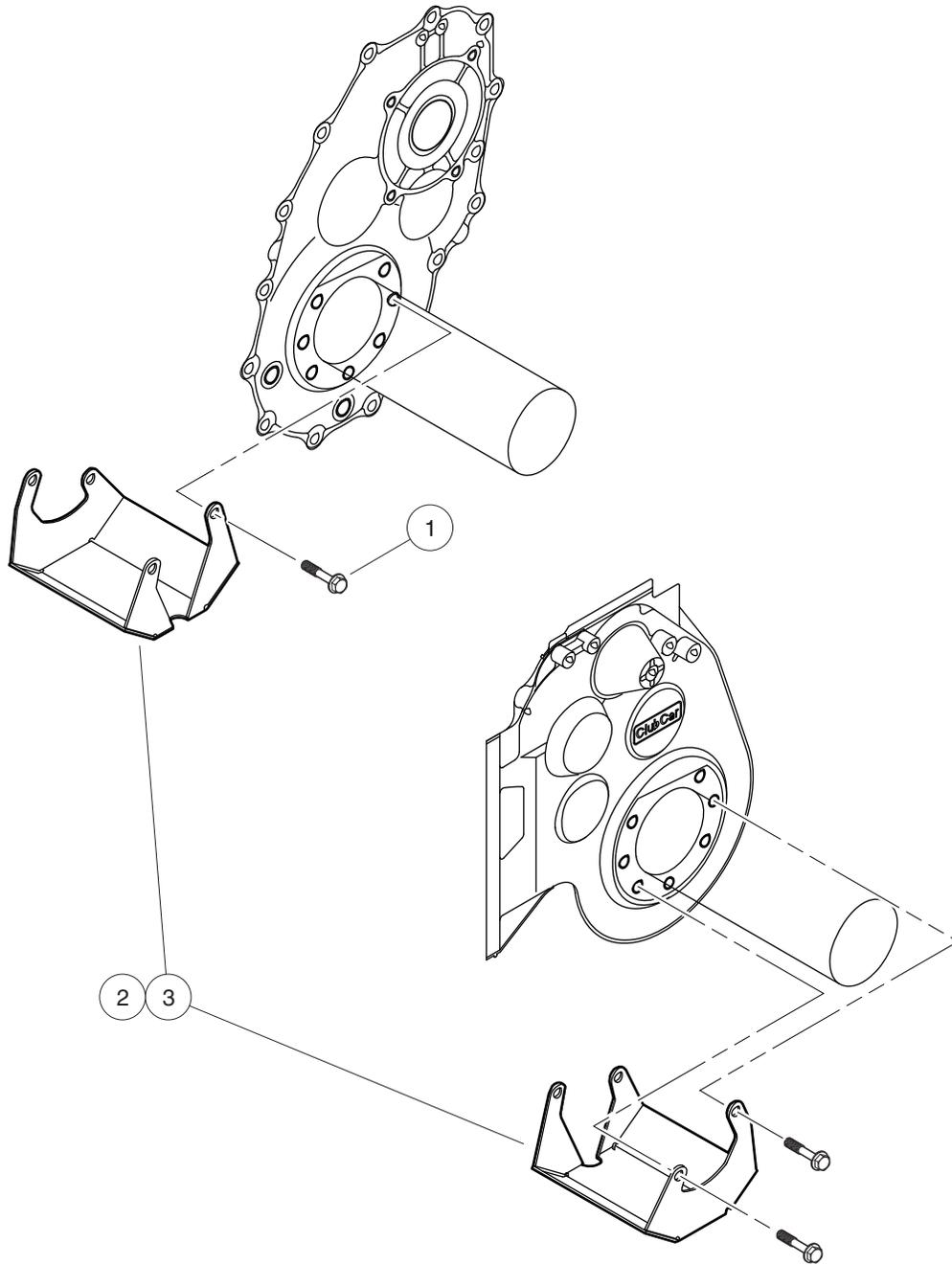

000366-001

DIFFERENTIAL GUARD – GASOLINE VEHICLE

ITEM	PART NO.	DESCRIPTION	QTY
		1 2 3 4	
1	<u>101926901</u>	Screw, M8-1.25 X 40mm Hex-Head	4
2	<u>101932902</u>	Diff Guard Unitized Kit (Includes Instructions) (includes item 3)	1
3	N/A	Guard, Unitized Differential	1

13

G

13

G

ELECTRICAL SYSTEM – ELECTRIC VEHICLES

14

E

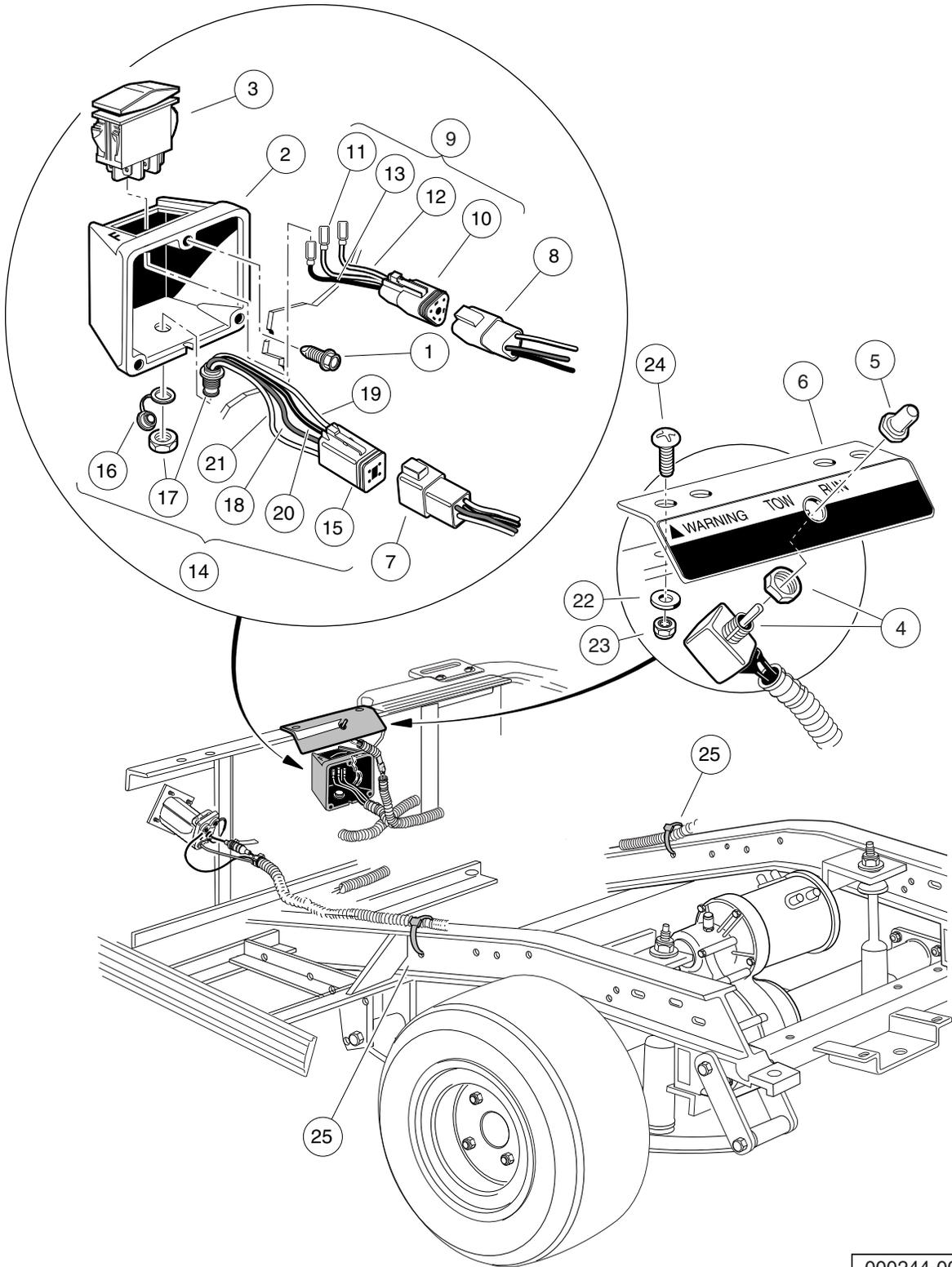

000244-001

FORWARD/REVERSE SWITCH, TOW/RUN SWITCH

ITEM	PART NO.	DESCRIPTION	QTY
		1 2 3 4	
1	<u>1012285</u>	Screw, 1/4 X 0.625 Hex-Head	3
2	101855002	Case, FNR Switch	1
3	<u>101856002</u>	Switch, Rocker, Single-Pole	1
4	<u>101908101</u>	Switch Assembly, Tow/Run	1
5	<u>101908401</u>	Boot, Switch	1
6	<u>101922501</u>	Bracket, Tow/Run Switch Mounting	1
7	<u>101932401</u>	Kit, 4-Pin Receptacle and Wedge Lock	1
8	<u>101942301</u>	Kit, 3-Pin Wedge Lock	1
9	<u>102266601</u>	Wire Assembly, FNR Switch (includes items 10 through 13)	1
10	<u>101920101</u>	Kit, 3-Pin Wedge Lock	1
11	N/A	Wire Assembly, #18 Blue	1
12	N/A	Wire Assembly, #18 Orange	1
13	N/A	Wire Assembly, #18 Brown	1
14	102266701	Wire Assembly, IQDM Port (includes items 15 through 21)	1
15	<u>101932501</u>	Kit, 4-Pin Wedge Lock	1
16	<u>102196901</u>	Dust Cap	1
17	N/A	Connector Mount, Four-Pin	1
18	N/A	Wire Assembly, #18 Red/Yellow	1
19	N/A	Wire Assembly, #18 Black/Yellow	1
20	N/A	Wire Assembly, #18 Blue/Yellow	1
21	N/A	Wire Assembly, #18 Green/Yellow	1
22	<u>332</u>	Washer, 1/4 Type A Narrow Flat	2
23	<u>8233</u>	Locknut, 1/4-20, Nylon Insert	2
24	<u>8248</u>	Screw, 1/4-20 X 0.75, Truss-Head Machine	2
25	<u>8990</u>	Tie Wrap, 8" Nylon	1

14

E

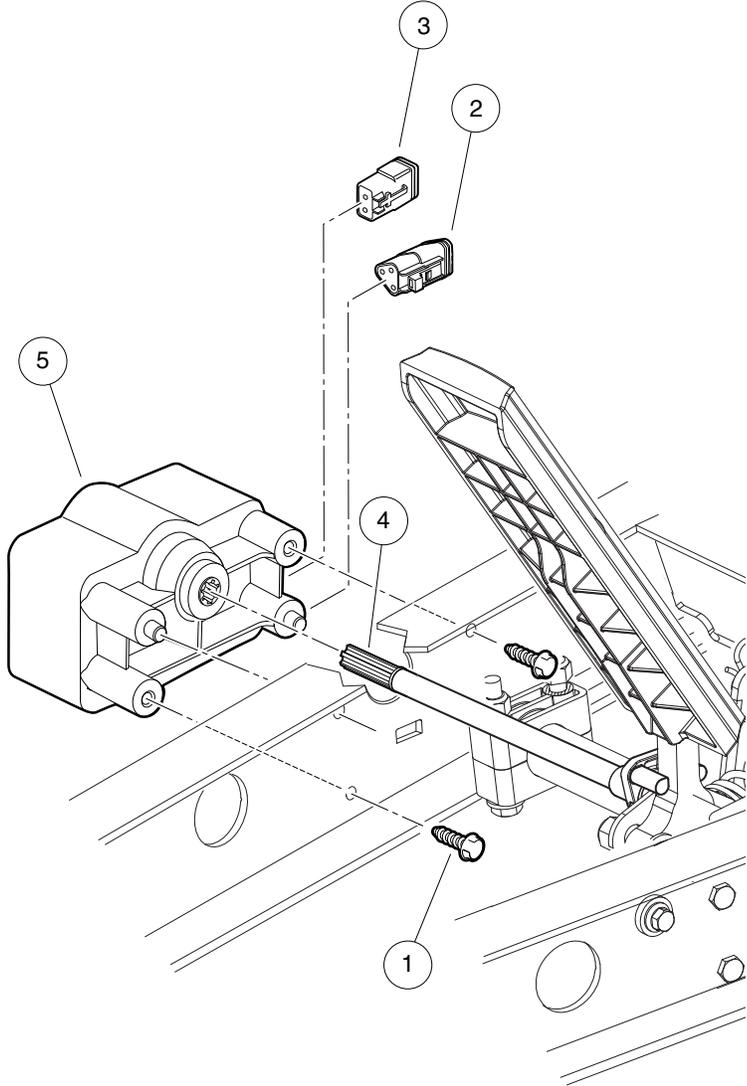

001070-001

MOTOR CONTROLLER OUTPUT REGULATOR (MCOR)

ITEM	PART NO.	DESCRIPTION	QTY
		1 2 3 4	
1	<u>1015752</u>	Screw, #12-16 X 0.625, Hi-Lo	2
2	<u>101920101</u>	Kit, 3-Pin Wedge Lock	1
3	<u>101936801</u>	Kit, 2-Pin Wedge Lock	1
4	102101001	Bar, Drive, Cast	1
5	<u>102101101</u>	MCOR	1

14

E

14

E

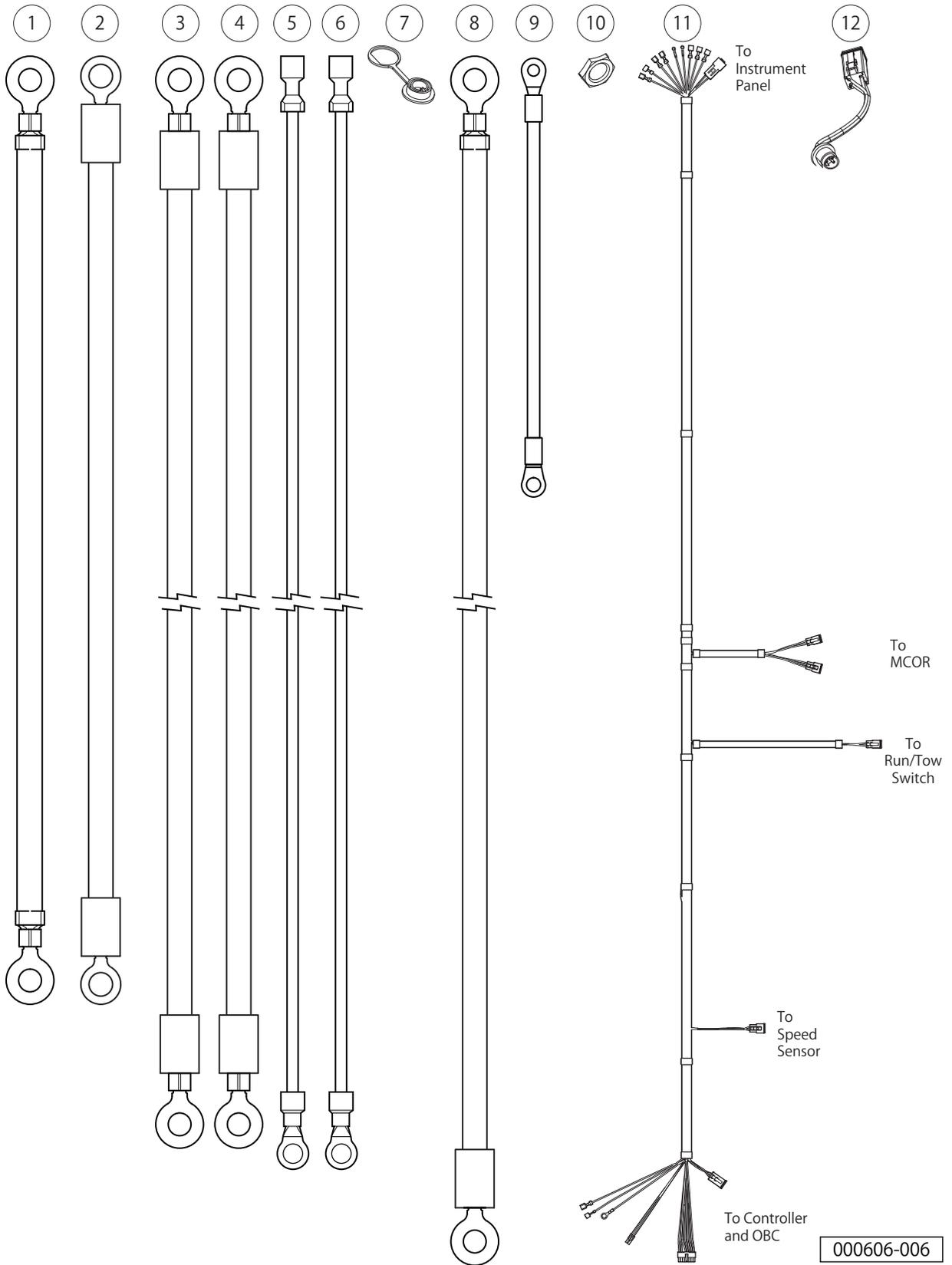

WIRING – XRT800/810 ELECTRIC

ITEM	PART NO.	DESCRIPTION	QTY
		1 2 3 4	
1	<u>101795701</u>	Asm, Wire, #6blk, 15 In	3
2	<u>101903001</u>	Wire Assembly #6 Yellow	1
3	<u>101968701</u>	Wire Assy, #6 White	1
4	<u>101978001</u>	Wire Assy, #6 Green	1
5	<u>101978101</u>	Asm, Wire, #10 Orange 5/16	1
6	<u>101978201</u>	Asm, Wire, #10 Blue 5/16	1
7	<u>102196901</u>	Dust Cap	1
8	<u>102199601</u>	Wire Asm, #6 Red, 37.7	1
9	<u>102263601</u>	Wire Assy, #10 Black	1
10	<u>102572401</u>	Nut, Diagnostic Port	1
11	<u>102810501</u>	Wire Harness, Electric Vehicle	1
12	<u>103218601</u>	Harness, Diagnostic Port	1

14

E

14

E

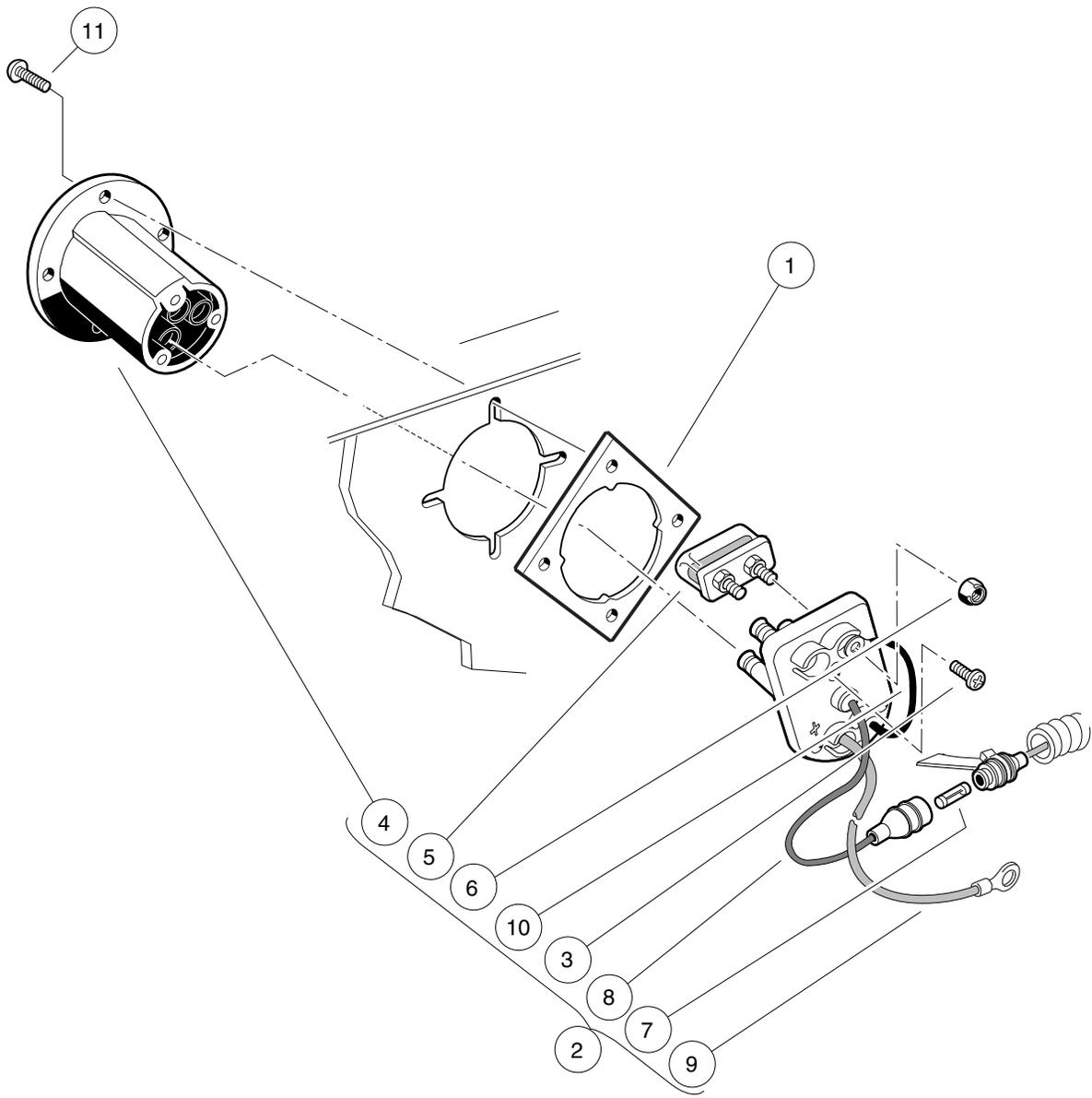

000369-001

BATTERY CHARGER RECEPTACLE

ITEM	PART NO.	DESCRIPTION	QTY
		1 2 3 4	
1	<u>101801001</u>	Plate, Receptacle Backing	1
2	<u>101802101</u>	Fuse and Receptacle Assembly (includes items 3 through 10)	1
3	<u>1017705</u>	Screw, #8 X 5/8 Phillips Pan-Head Type AB	3
4	<u>101796501</u>	Receptacle	1
5	<u>101796801</u>	Fuse Assembly (includes item 6)	1
6	<u>1013061</u>	Locknut, #10-32 Nylon Insert	2
7	<u>101894901</u>	Fuse, 3/8-Amp	1
8	N/A	Wire Assembly, Sense Lead, Gray	1
9	N/A	Wire Assembly, #10 Red	1
10	N/A	Wire Assembly, #10 Black	1
11	<u>101832001</u>	Screw, #7-19 X 0.625 Phillips Pan-Head Tap	4

14

E

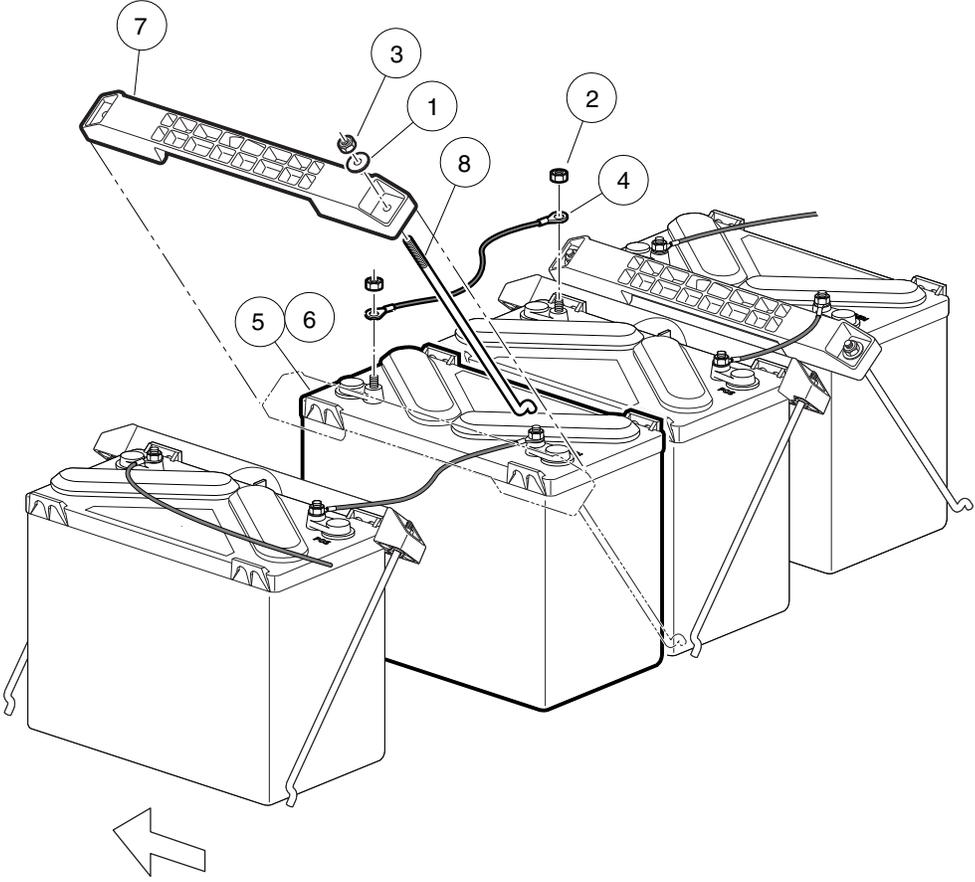

000241-002

BATTERIES, ELECTRIC VEHICLE

ITEM	PART NO.	DESCRIPTION	QTY
		1 2 3 4	
1	<u>1011697</u>	Washer, 5/16 Flat	8
2	<u>1014304</u>	Nut, 5/16-18 Stainless-Steel Hex	8
3	1015072	Locknut, 5/16-18 Nylon Insert	8
4	<u>101795701</u>	Asm, Wire, #6blk 13in	3
5	<u>102511301</u>	Battery, Ventmaster 12-Volt (Wet)	4
6	<u>102511302</u>	Battery, Ventmaster 12-Volt (Dry, also known as moist)	4
7	<u>102777401</u>	Battery Hold-Down	4
8	<u>102832601</u>	Bolt, Battery, J-	8

14

E

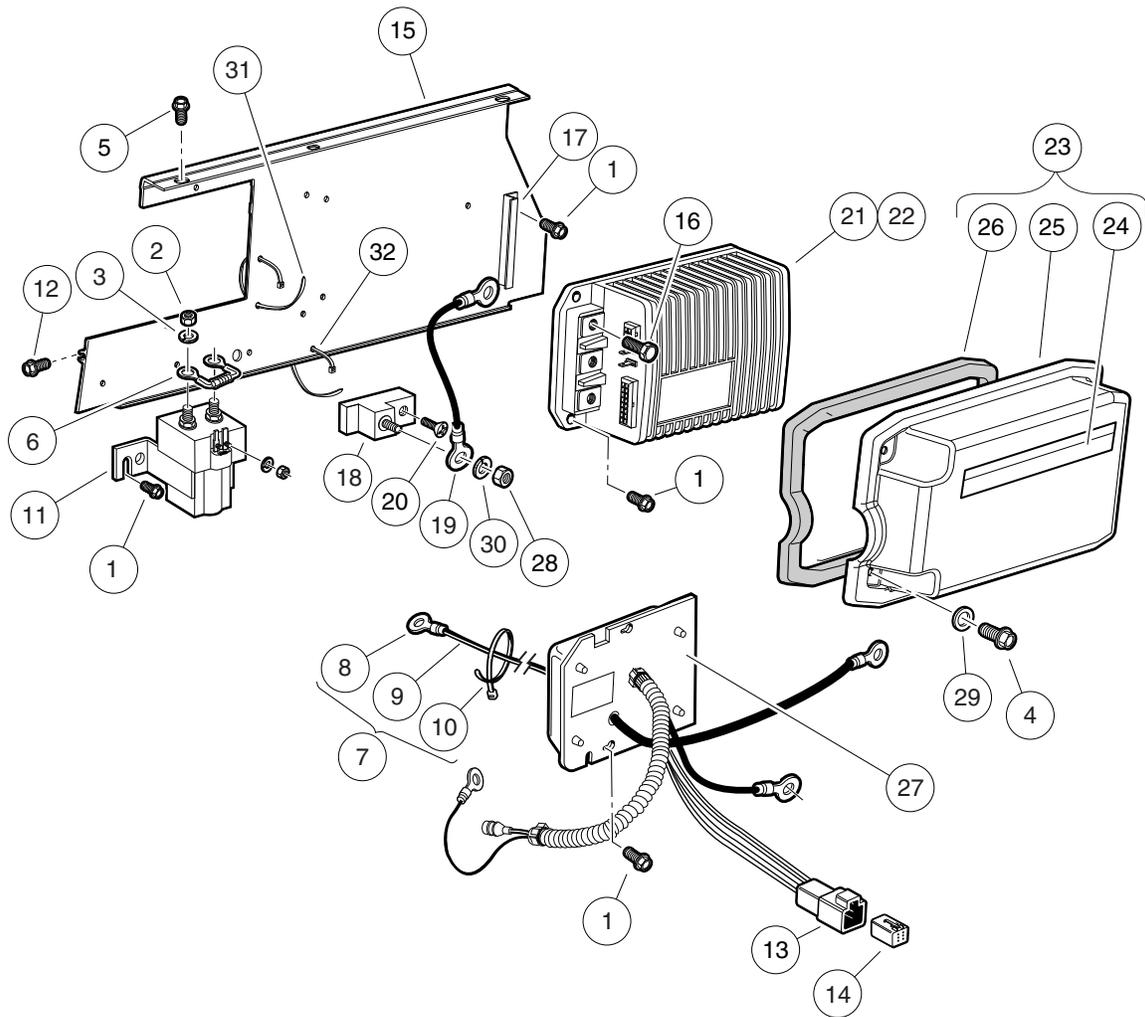

000607-003

COMPUTER, CONTROLLER, AND SOLENOID

ITEM	PART NO.	DESCRIPTION	QTY
		1 2 3 4	
1	<u>1012285</u>	Screw, 1/4 X 0.625 Hex-Head	14
2	<u>1012528</u>	Nut, M8-1.25 Hex	2
3	<u>1013734</u>	Lockwasher, 8mm Split	2
4	<u>1014063</u>	Screw, 1/4-20 X 1.00, Hex Head	2
5	<u>1014288</u>	Screw, 5/16-18 X 0.75, Thread-Forming	2
6	<u>1014947</u>	Resistor Assembly	1
7	101827801	Ground Wire Kit, 48-Volt (includes items 8 through 10)	1
8	101826801	Compression Lug	1
9	N/A	Wire Assembly, Black	1
10	<u>8990</u>	Tie Wrap, 8" Nylon	3
11	<u>101908703</u>	Solenoid, 48v W/ Diode	1
12	<u>101910401</u>	Screw, 5/16-18 X 1.25 Thrd Frm	2
13	<u>101932601</u>	Kit, 6-Pin Wedge Lock	1
14	<u>101932701</u>	Kit, 6-Pin Receptacle and Wedge Lock	1
15	<u>101965205</u>	Plate, Component Mounting	1
16	<u>102240501</u>	Bolt, Controller, Terminal	3
17	<u>102243101</u>	Extrusion, Cover Support	1
18	<u>102259801</u>	Terminal Block	1
19	<u>102263601</u>	Wire Assy, #10 Black	1
20	<u>102263701</u>	Screw, #10-24 X 0.75 Phillips, Thread-Forming	1
21	<u>102806201</u>	Controller, IQ, 48-volt	1
22	<u>102806203</u>	Controller, IQ, 48-volt, CE	1
23	<u>103316901</u>	Cover Asm - Controller (includes items 24 through 26)	1
24	<u>101931501</u>	Decal, Component Cover	1
25	<u>103316701</u>	Cover - Controller, Deep	1
26	<u>103316801</u>	Gasket - Controller Cover	1
27	103403101	Asm, Obc, Iq, V3.0	1
28	<u>1242</u>	Nut, 5/16-18 Hex	1
29	<u>332</u>	Washer, 1/4 Type A Narrow Flat	2
30	<u>7174</u>	Lockwasher, 5/16 Split	1
31	<u>8639</u>	Tie Wrap, 11" Nylon	1
32	<u>8990</u>	Tie Wrap, 8" Nylon	1

14

E

14

E

ELECTRIC MOTOR

15

E

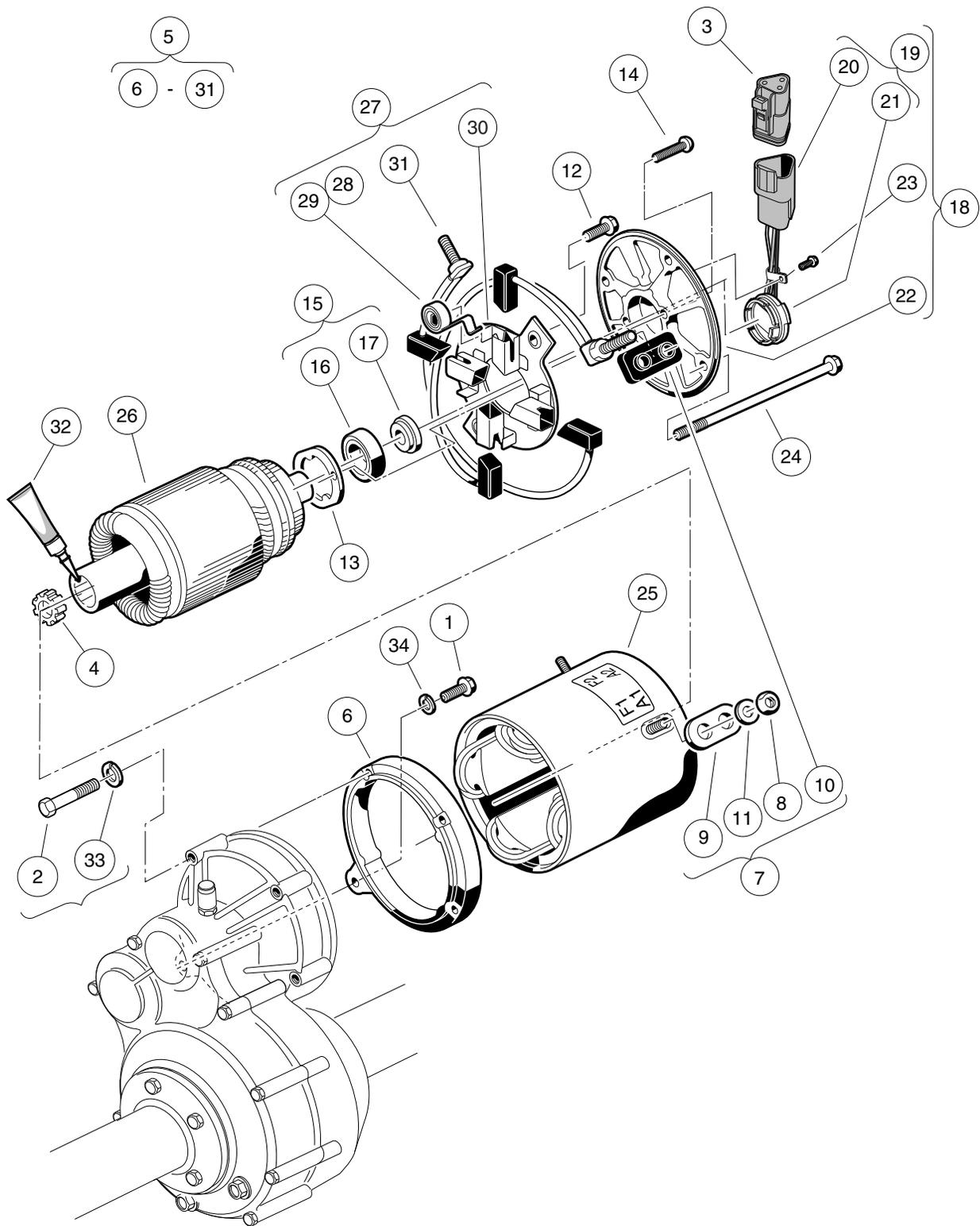

000349-002

MOTOR (MODEL 5BC59JBS6390) – ELECTRIC VEHICLE

ITEM	PART NO.	DESCRIPTION	QTY
		1 2 3 4	
1	<u>1010934</u>	Screw, 5/16-18 X 1.00 Hex Cap	1
2	<u>1014201</u>	Screw, 1/4-20 X 2.25 Hex Cap	3
3	<u>101920101</u>	Kit, 3-Pin Wedge Lock	1
4	<u>102235201</u>	Bumper, Drive Unit	1
5	<u>102240104</u>	Motor, 48-Volt Non-Skew IQ (includes items 6 through 27)	1
6	<u>1017944</u>	End Shield	1
7	<u>1017947</u>	Hardware Package (includes items 8 through 11)	1
8	<u>1011280</u>	Locknut, 5/16-18	4
9	N/A	Insulator Bushing	2
10	N/A	Insulated Bushing	2
11	<u>1241</u>	Washer, 5/16 Type A Flat	4
12	<u>1017949</u>	Screw, #6-32 X 0.480 Hex-Head	2
13	<u>1017950</u>	Bearing Retainer	1
14	<u>1017953</u>	Screw, Bearing Retainer	2
15	<u>102265701</u>	Kit, Bearing and Magnet (includes items 16 and 17)	1
16	<u>1011290</u>	Ball Bearing	1
17	<u>102265801</u>	Magnet	1
18	<u>102265901</u>	Motor End Shield Asm (includes items 19 through 23)	1
19	<u>102265601</u>	Speed Sensor Assembly (includes items 20 and 21)	1
20	<u>101942301</u>	Kit, 3-Pin Wedge Lock	1
21	N/A	Sensor, Speed, without Connector	1
22	<u>102266001</u>	End Shield, Motor	1
23	<u>102267001</u>	Screw, #8-32 X 0.375 Hex-Head	1
24	<u>102266101</u>	Screw, #10 - 32 X 8.250	4
25	<u>103325701</u>	Stator Shell and Winding	1
26	<u>103325801</u>	Non Skew Armature	1
27	<u>103337601</u>	Brush Assembly, IQ Motor, Non-Skew (includes items 28 through 31)	1
28	<u>1011411</u>	Kit, Brush Spring (ge Motor) (includes item 29)	1
29	<u>1011285</u>	Brush Spring	4
30	<u>103325501</u>	Brush Rigging, Non-Skew Motor	1
31	<u>103325601</u>	Brush Set, Non-Skew	1
32	<u>102243403</u>	Lubricant, Moly-Teflon (Single-Use Tube)	1
33	<u>451</u>	Lockwasher, 1/4 Split	3
34	<u>7174</u>	Lockwasher, 5/16 Split	1

15

E

15

E

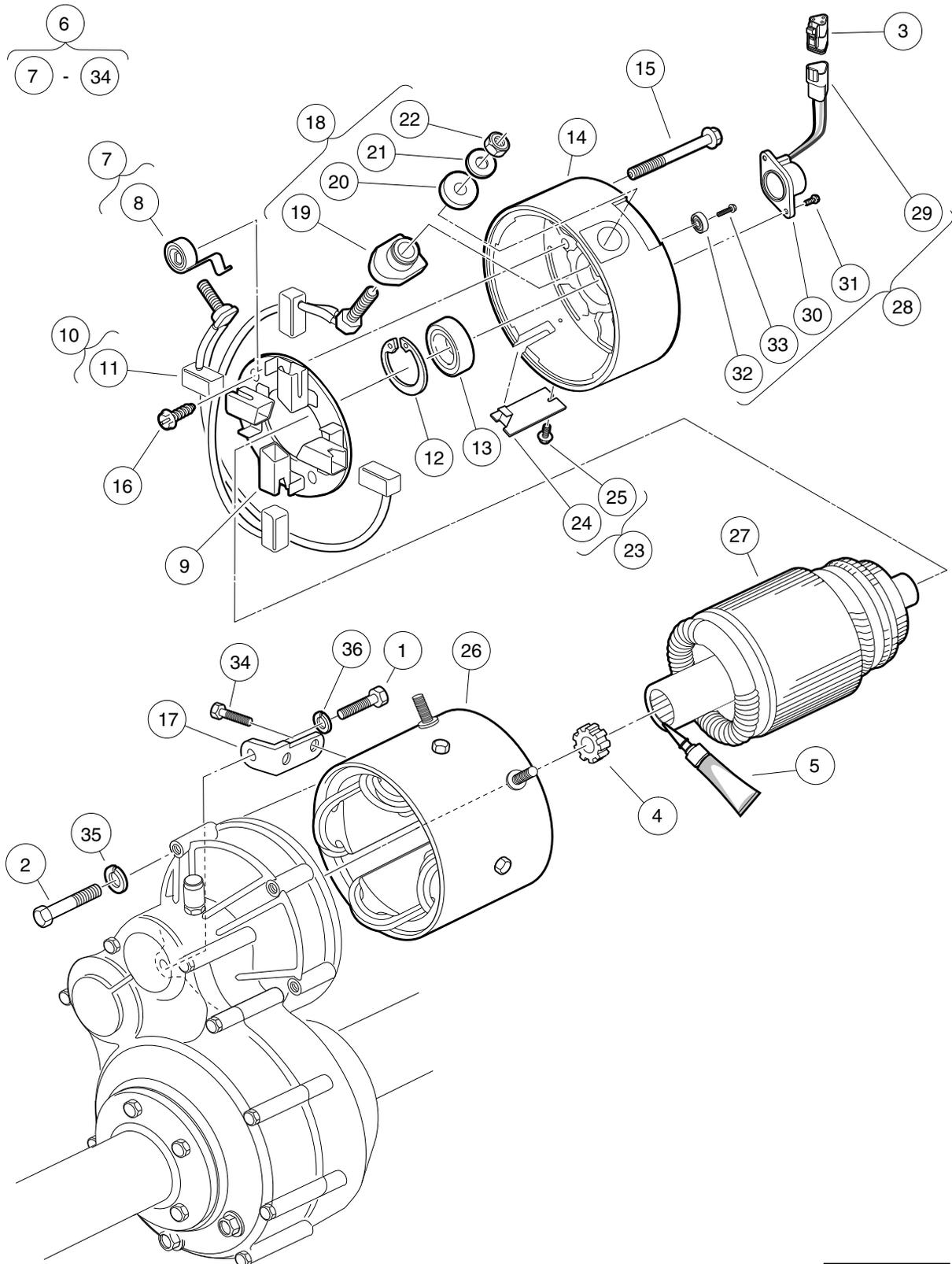

000185-001

MOTOR (MODEL EJ4-4001) – ELECTRIC VEHICLE

ITEM	PART NO.	DESCRIPTION	QTY
		1 2 3 4	
1	<u>1010934</u>	Screw, 5/16-18 X 1.00 Hex Cap	1
2	1014201	Screw, 1/4-20 X 2.25 Hex Cap	3
3	<u>101920101</u>	Kit, 3-Pin Wedge Lock	1
4	<u>102235201</u>	Bumper, Drive Unit	1
5	<u>102243403</u>	Lubricant, Moly-Teflon (Single-Use Tube)	1
6	<u>102705001</u>	IQ Electric Motor, 48-VDC 3.3 hp (includes items 7 through 34)	1
7	<u>102186001</u>	Spring Kit, Motor Brush (includes item 8)	1
8	N/A	Spring, Brush, S-g	4
9	<u>102186101</u>	Brush Box Assembly	1
10	<u>102186201</u>	Brush Kit, Motor (includes item 11)	1
11	N/A	Assembly, Brush and Terminal	2
12	N/A	Ring, 2.24" Internal Retaining	1
13	<u>102186401</u>	Bearing, Ball	1
14	<u>102186701</u>	End Cap, Motor	1
15	N/A	Screw, 1/4-20 X 2.25 Hex-Head Washer	2
16	<u>102186901</u>	Screw, #8-32 X .5 Hex-Head	2
17	<u>102187001</u>	L-Bracket, Motor	1
18	<u>102187101</u>	Hardware Kit, Motor Terminal (includes items 19 through 22)	2
19	N/A	Bushing, Nylon	2
20	N/A	Washer, Nylon Flat	2
21	N/A	Washer, Flat, 5/16 Steel	2
22	N/A	Nut, Brass Hex, 5/16 - 18	2
23	<u>102187201</u>	Plate Kit, Motor Cover (includes items 24 and 25)	1
24	N/A	Assembly, Cover Plate	1
25	N/A	Screw, #8-32 x 0.375, Taptite Thread	1
26	<u>102704701</u>	Frame and Field Assembly	1
27	<u>102704801</u>	Armature Assembly	1
28	<u>102704901</u>	Kit, Speed Sensor (includes items 29 through 33)	1
29	<u>101942301</u>	Kit, 3-Pin Wedge Lock	1
30	N/A	Sensor, Motor Speed, ADC	1
31	N/A	Screw, #8-32, Taptite Thread	2
32	N/A	Magnet, ADC Motor	1
33	N/A	Screw, 1/4-20 x 0.5	1
34	N/A	Bolt, 1/4 - 20 x 0.73 Thread-Forming	2
35	<u>451</u>	Lockwasher, 1/4 Split	3
36	<u>7174</u>	Lockwasher, 5/16 Split	1

15

E

15

E

TRANSAXLE – ELECTRIC VEHICLES

16

E

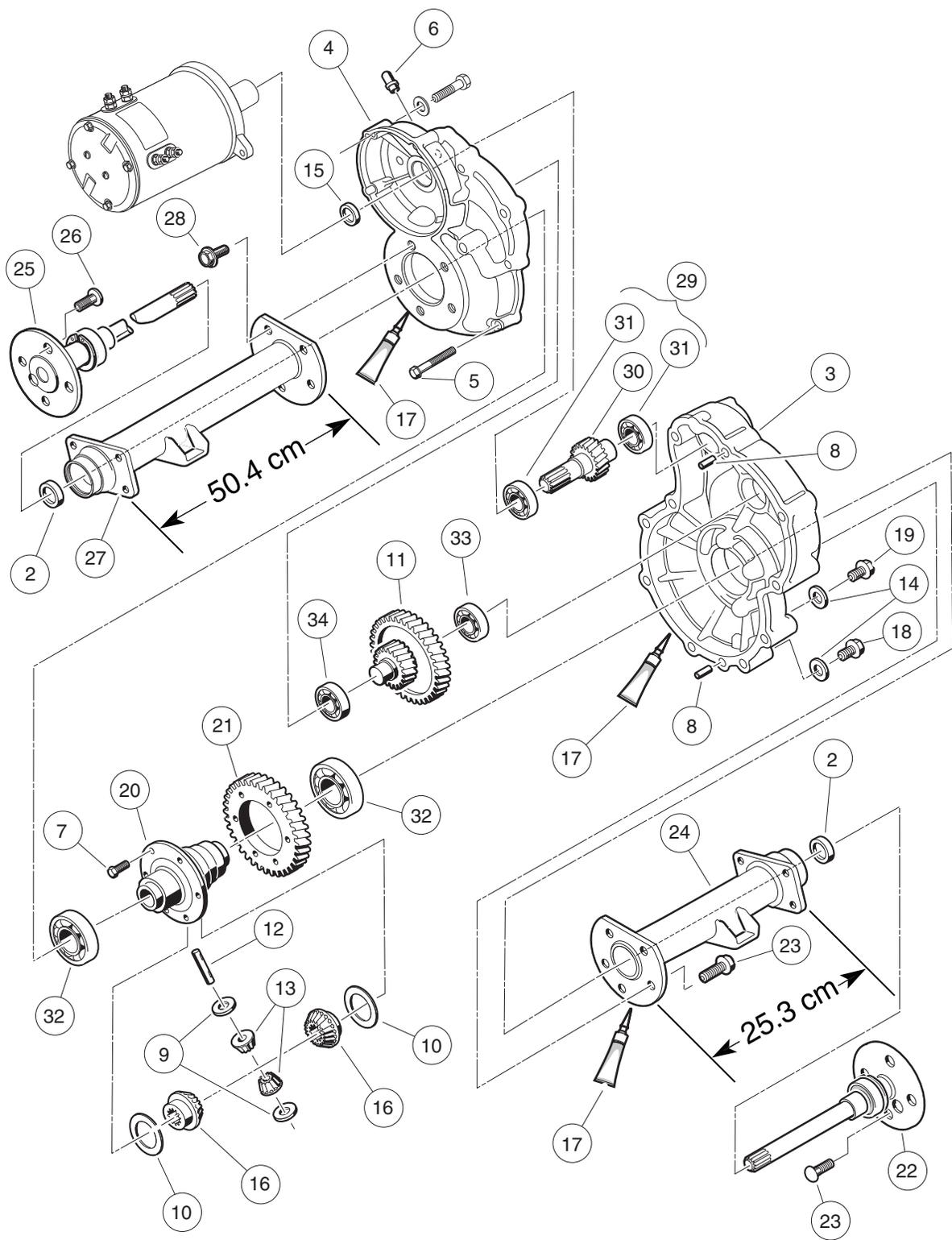

000223-005

TRANSAXLE – ELECTRIC VEHICLES

ITEM	PART NO.	DESCRIPTION	QTY
		1 2 3 4	
1	<u>102771701</u>	Transaxle, Electric (includes items 2 through 34)	1
2	<u>1013794</u>	Axle Shaft Oil Seal	2
3	<u>101895401</u>	Gear Case, Driver-Side	1
4	<u>101895501</u>	Gear Case, Passenger-Side	1
5	<u>101897001</u>	Screw, M8-1.25 X 60mm Hex-Head	11
6	<u>101897201</u>	Breather	1
7	<u>101897401</u>	Screw, M10-1.25 X 25mm	6
8	<u>101897601</u>	Pin, 11mm OD X 8.5mm ID X 10mm	2
9	<u>101903601</u>	Washer, Thrust	2
10	<u>101903701</u>	Washer, Thrust	2
11	<u>101906901</u>	Intermediate Shaft Assembly	1
12	<u>101922101</u>	Pin, 15.99mm X 88.7mm Dowel	1
13	<u>101923001</u>	Gear, Differential Idler	2
14	<u>101923201</u>	Gasket	2
15	<u>101923501</u>	Seal, Lip	1
16	<u>101923901</u>	Gear, Differential	2
17	<u>101928701</u>	Liquid Gasket (Transaxle case)	1
18	<u>101972101</u>	Plug, M14-1.5 X 12mm Magnetic	1
19	<u>101972201</u>	Plug, M14-1.5 X 12mm Hex	1
20	<u>102356601</u>	Housing, Differential, 6 Bolt	6
21	<u>102356801</u>	Gear, Differential Output, 6-Bolt	6
22	<u>102886301</u>	Axle Assembly, Driver-Side (includes item 23)	1
23	<u>101922201</u>	Lug Stud	4
24	<u>102886401</u>	Tube, Axle, Driver-Side	1
25	<u>102886501</u>	Axle Assembly, Passenger-Side (includes item 26)	1
26	<u>101922201</u>	Lug Stud	4
27	<u>102886601</u>	Tube, Axle, Passenger-Side	1
28	<u>102902801</u>	Screw, M10 X 30	10
29	<u>103582801</u>	Asm, E Trans Shaft/bearing (includes items 30 and 31)	1
30	N/A	Shaft, Input	1
31	<u>7335</u>	Bearing	2
32	<u>7330</u>	Inner Axle Tube Bearing	2
33	<u>7335</u>	Bearing	1
34	<u>7336</u>	Bearing	1

16

E

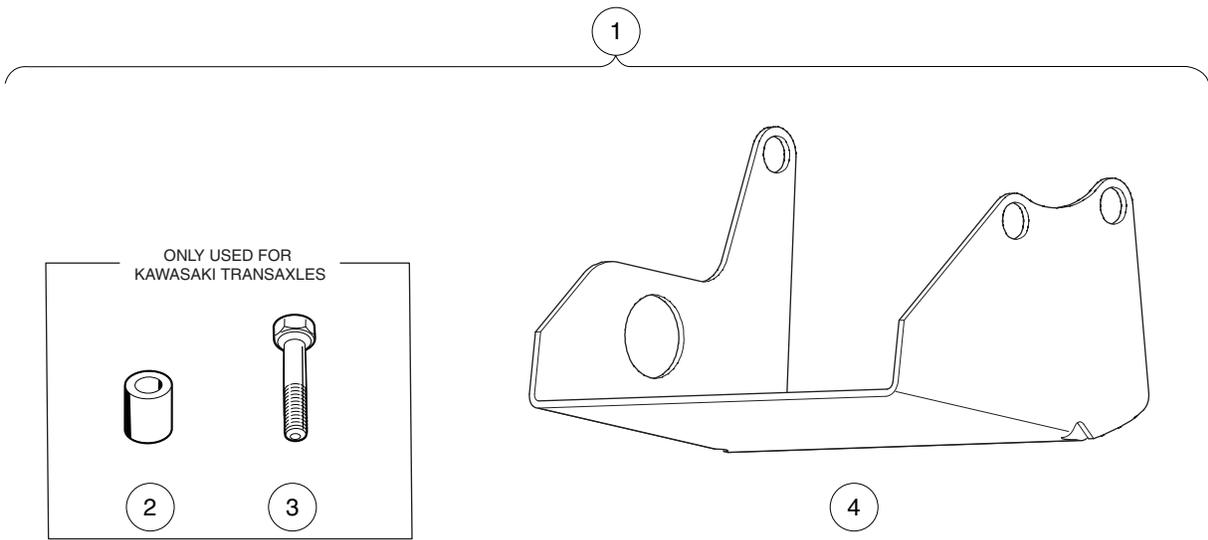

000365-002

DIFFERENTIAL GUARD – ELECTRIC VEHICLES

ITEM	PART NO.	DESCRIPTION	QTY
		1 2 3 4	
1	<u>101611402</u>	Kit, Differential Guard, Elec Vehicles (includes items 2 through 4)	1
2	<u>101914001</u>	Spacer, Steel	2
3	<u>101936101</u>	Screw, M10-1.50 X 60mm Hex Cap	2
4	<u>101978601</u>	Guard, Differential, Electric Vehicle Transaxle	1

16

E

16

E

BATTERY CHARGERS

17

E

- 1
- 2
- 3

- 23

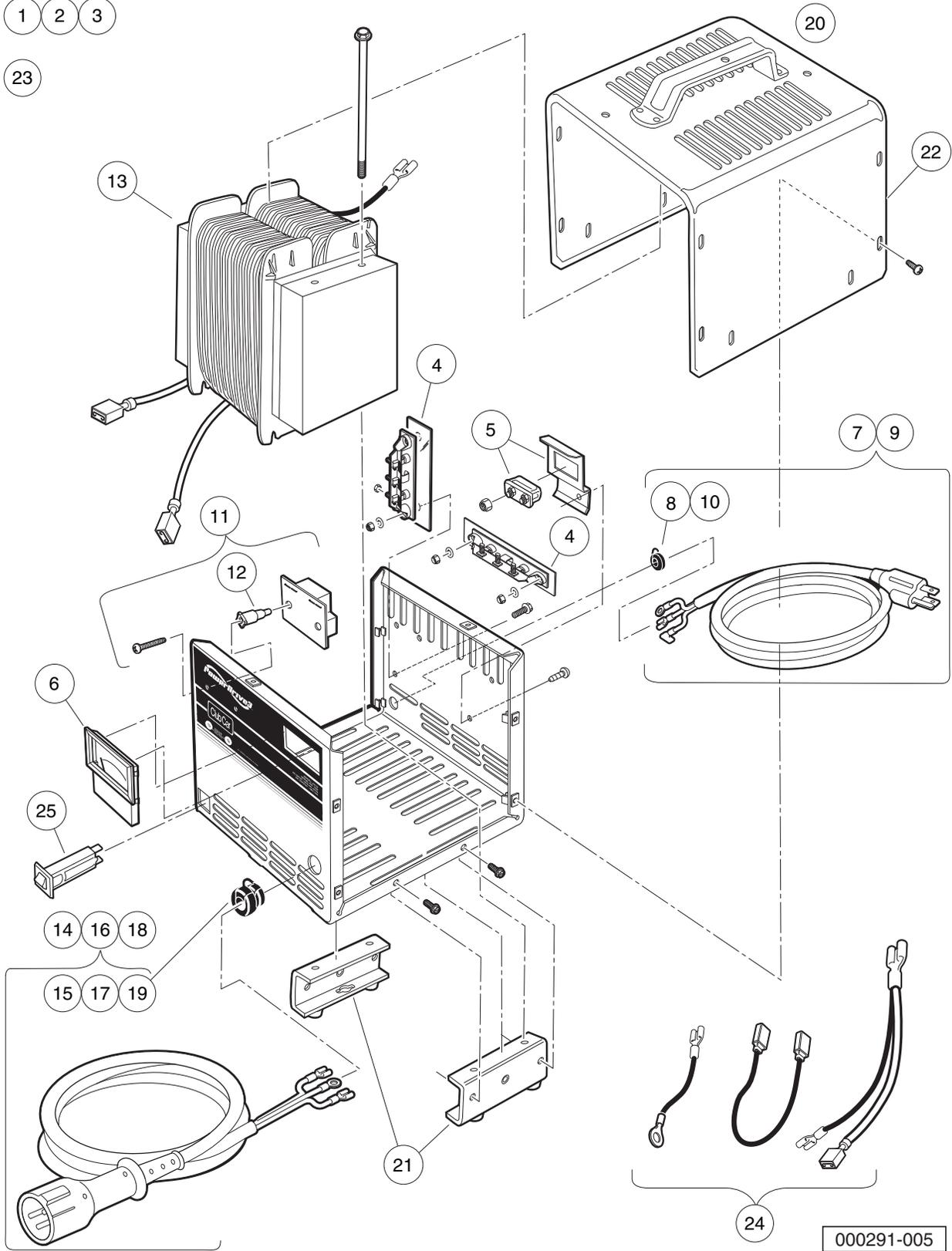

000291-005

POWERDRIVE 3 BATTERY CHARGER (MODEL 26580), DOMESTIC

ITEM	PART NO.	DESCRIPTION	QTY
		1 2 3 4	
1	103499101	Charger, PowerDrive 3, 9ft DC, 6ft AC	1
2	<u>103499102</u>	Charger, PowerDrive 3, 12ft DC, 9ft AC	1
3	<u>103499103</u>	Charger, PowerDrive 3, 20ft DC, 9ft AC (includes items 4 through 25)	1
4	<u>1015914</u>	Rectifier with Heatsink Assembly	2
5	<u>102273701</u>	PD2 Fuse Asm	1
6	<u>102273801</u>	PD2 Ammeter	1
7	<u>103428501</u>	Kit, PD3 Cordset - AC 80" (includes item 8)	1
8	<u>102273901</u>	PD2 AC Cord Bushing	1
9	<u>103428601</u>	Kit, PD3 Cordset, - AC 114" (includes item 10)	1
10	<u>102273901</u>	PD2 AC Cord Bushing	1
11	<u>103428701</u>	Asm, PD3 Board Relay (includes item 12)	1
12	<u>103429701</u>	PD3 Plastic Stand-Offs	2
13	<u>103428801</u>	PD3 Transformer	1
14	<u>103429001</u>	PD3 Cordset - DC 113" (includes item 15)	1
15	<u>1012098</u>	Bushing, DC Cord	1
16	<u>103429101</u>	PD3 Cordset - DC 154" (includes item 17)	1
17	<u>1012098</u>	Bushing, DC Cord	1
18	<u>103429201</u>	PD3 Cordset - DC 205" (includes item 19)	1
19	<u>1012098</u>	Bushing, DC Cord	1
20	<u>103429301</u>	Asm, PD3 Case (includes items 21 and 22)	1
21	<u>103434001</u>	Asm, PD3 Legs	1
22	<u>103439901</u>	PD3Case Top (Includes Handle)	1
23	<u>103429501</u>	Kit, PD3 Hardware	1
24	<u>103429601</u>	Kit, PD3 Wires	1
25	<u>CCX8506</u>	Circuit Breaker, 15-Amp/120-Volt	1

17

E

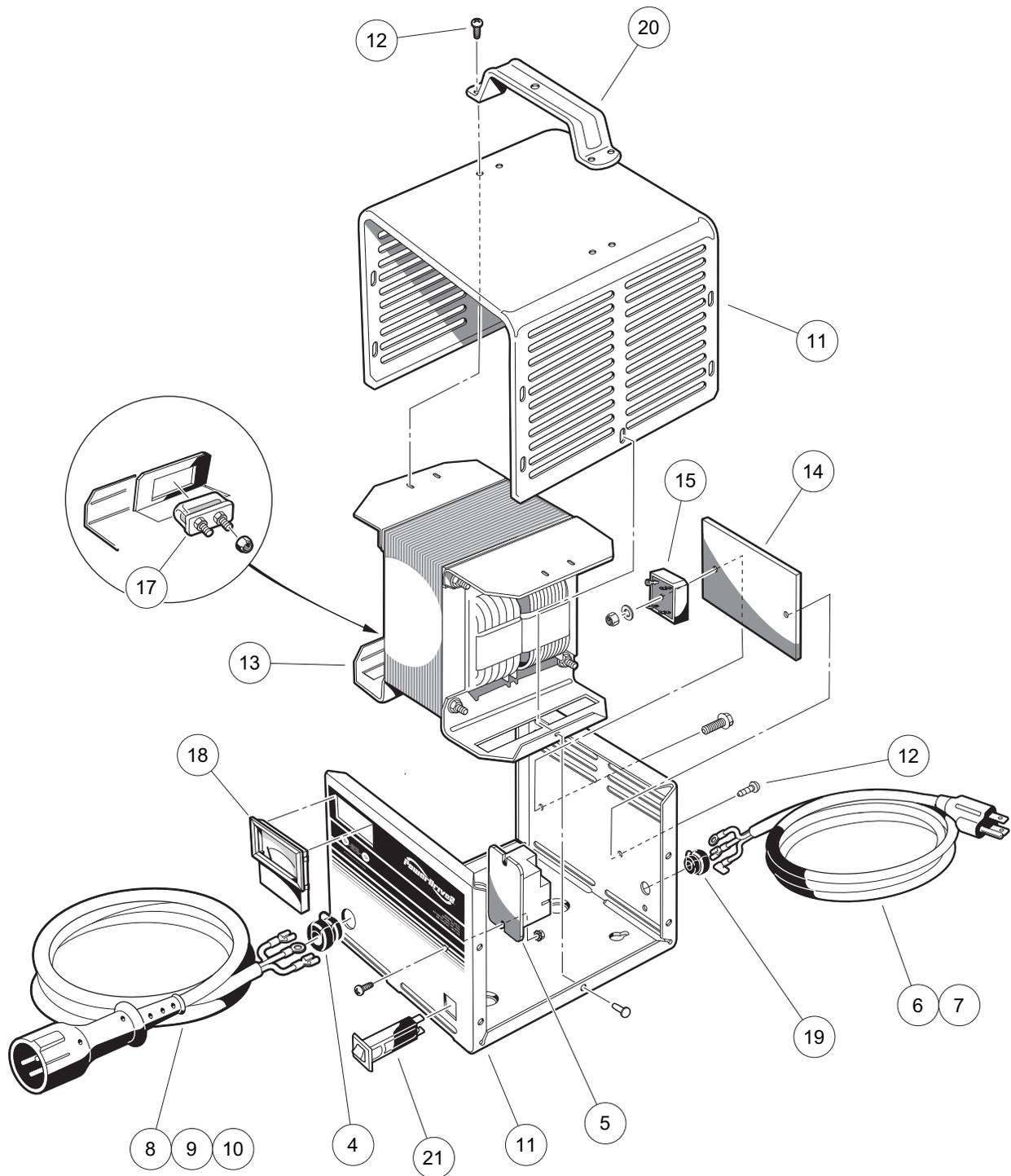

000291-004

POWERDRIVE 2 BATTERY CHARGER (MODEL 22110), DOMESTIC

ITEM	PART NO.	DESCRIPTION	QTY
		1 2 3 4	
1	<u>101802204</u>	48-V/13-A PowerDrive 2 (9-ft. DC, 6-ft. AC)	1
2	<u>101802205</u>	48-V/13-A PowerDrive 2 (12-ft. DC, 9-ft. AC)	1
3	<u>101802206</u>	48-V/13-A PowerDrive 2 (20-ft. DC, 9-ft. AC) (includes items 4 through 21)	1
4	<u>1012098</u>	Bushing, DC Cord	1
5	<u>101828601</u>	Relay, 48-Volt	1
6	<u>101828801</u>	Cord, AC, 80-Inch (203 cm)	1
7	<u>101828802</u>	Cord, AC, 108-Inch (274 cm)	1
8	<u>101828904</u>	PD2 DC Cordset, 113-inch	1
9	<u>101828905</u>	PD2 DC Cordset, 154-inch	1
10	<u>101828906</u>	Pd2 Dc Cordset 250 Inch	1
11	<u>102273201</u>	PD2 Case (includes item 12)	1
12	7577	Screw, #10 X 0.50 Phillips Pan-Head	12
13	<u>102273301</u>	PD2 Transformer Asm	1
14	<u>102273401</u>	PD2 Heatsink	1
15	<u>102273501</u>	PD2 Diode Bridge w/Film	1
16	<u>102273601</u>	PD2 Wire Asm	1
17	<u>102273701</u>	PD2 Fuse Asm	1
18	<u>102273801</u>	PD2 Ammeter	1
19	<u>102273901</u>	PD2 AC Cord Bushing	1
20	<u>102274001</u>	PD2 Handle	1
21	<u>CCX8506</u>	Circuit Breaker, 15-Amp/120-Volt	1
<p>Note: Item 16 not shown. Level 1 Battery Charger part numbers include one AC and one DC cord. They do not include all of the level 2 cords listed.</p>			

17

E

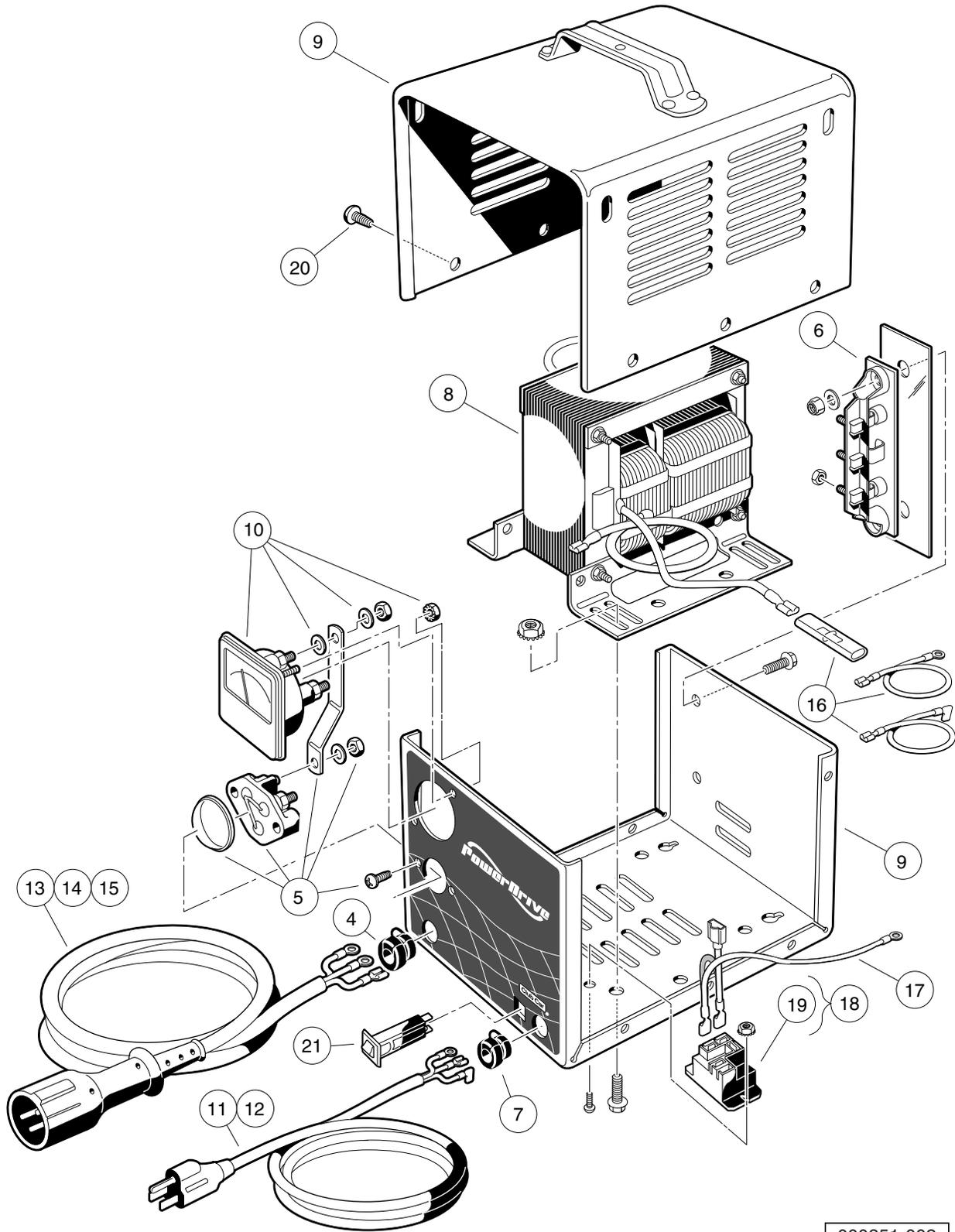

000351-002

POWERDRIVE BATTERY CHARGER (MODEL 17930), DOMESTIC

17

E

ITEM	PART NO.	DESCRIPTION	QTY
		1 2 3 4	
1	<u>101802201</u>	Charger, PowerDrive, 48V/17A, 9ft DC, 6ft AC Cord	1
2	<u>101802202</u>	Charger, PowerDrive, 48V/17A, 12ft DC, 9ft AC Cord	1
3	<u>101802203</u>	Charger, PowerDrive, 48V/17A, 20ft DC, 9ft AC Cord (includes items 4 through 21)	1
4	<u>1012098</u>	Bushing, DC Cord	1
5	<u>1012101</u>	Fuse Assembly	1
6	<u>1015914</u>	Rectifier with Heatsink Assembly	1
7	<u>1015917</u>	Bushing, AC Cord	1
8	<u>101819701</u>	Transformer, Battery Charger	1
9	<u>101828301</u>	Case Assembly	1
10	<u>101828501</u>	Ammeter	1
11	<u>101828801</u>	Cord, AC, 80-Inch (203 cm)	1
12	<u>101828802</u>	Cord, AC, 108-Inch (274 cm)	1
13	<u>101828901</u>	Cord, DC, 113-Inch (287 cm)	1
14	<u>101828902</u>	Cord, DC, 154-Inch (391 cm)	1
15	<u>101828903</u>	Cord, DC, 250-Inch (635 cm)	1
16	<u>101831101</u>	Wire Assembly Kit	1
17	101914401	Assembly, Voltage Suppressor	1
18	<u>103414901</u>	Kit, Relay, 48v 30a W/instr (includes item 19)	1
19	<u>103397901</u>	Relay, Spst No, 48v 30a, Pmt	1
20	7577	Screw, #10 X 0.50 Phillips Pan-Head	10
21	<u>CCX8506</u>	Circuit Breaker, 15-Amp/120-Volt	1
<p>Note: Level 1 Battery Charger part numbers include one AC and one DC cord. They do not include all of the level 2 cords listed.</p>			

POWERDRIVE BATTERY CHARGER (MODEL 18780), EXPORT

ITEM	PART NO.	DESCRIPTION	QTY
		1 2 3 4	
1	101831503	Battery Charger, 48-Volt DC (8.5-ft DC, 6-ft AC)	1
2	101831504	Battery Charger, 48-Volt DC (12-ft DC, 9-ft AC) (includes items 3 through 20)	1
3	<u>1012098</u>	Bushing, DC Cord	1
4	<u>1012101</u>	Fuse Assembly	1
5	<u>1015914</u>	Rectifier with Heatsink Assembly	1
6	<u>1015917</u>	Bushing, AC Cord	1
7	<u>101828501</u>	Ammeter	1
8	<u>101828901</u>	Cord, DC, 113-Inch (287 cm)	1
9	<u>101828902</u>	Cord, DC, 154-Inch (391 cm)	1
10	<u>101831701</u>	Cord, AC, 80-Inch (203 cm), without Plug	1
11	<u>101831702</u>	Cord, AC, 118-Inch (300 cm), without Plug	1
12	<u>101838201</u>	Transformer, Export Battery Charger	1
13	<u>101838301</u>	Relay, Export Charger	1
14	<u>101838401</u>	Circuit Breaker	2
15	<u>101838501</u>	Kit, Wire Assembly	1
16	<u>101838601</u>	Four-Position Switch	1
17	<u>101838701</u>	Mounting Bracket, Relay	1
18	<u>101914401</u>	Assembly, Voltage Suppressor	1
19	N/A	Case, Charger	1
20	7577	Screw, #10 X 0.50 Phillips Pan-Head	10
<p>Note: Level 1 Battery Charger part numbers include one AC and one DC cord. They do not include all of the level 2 cords listed.</p>			

17

E

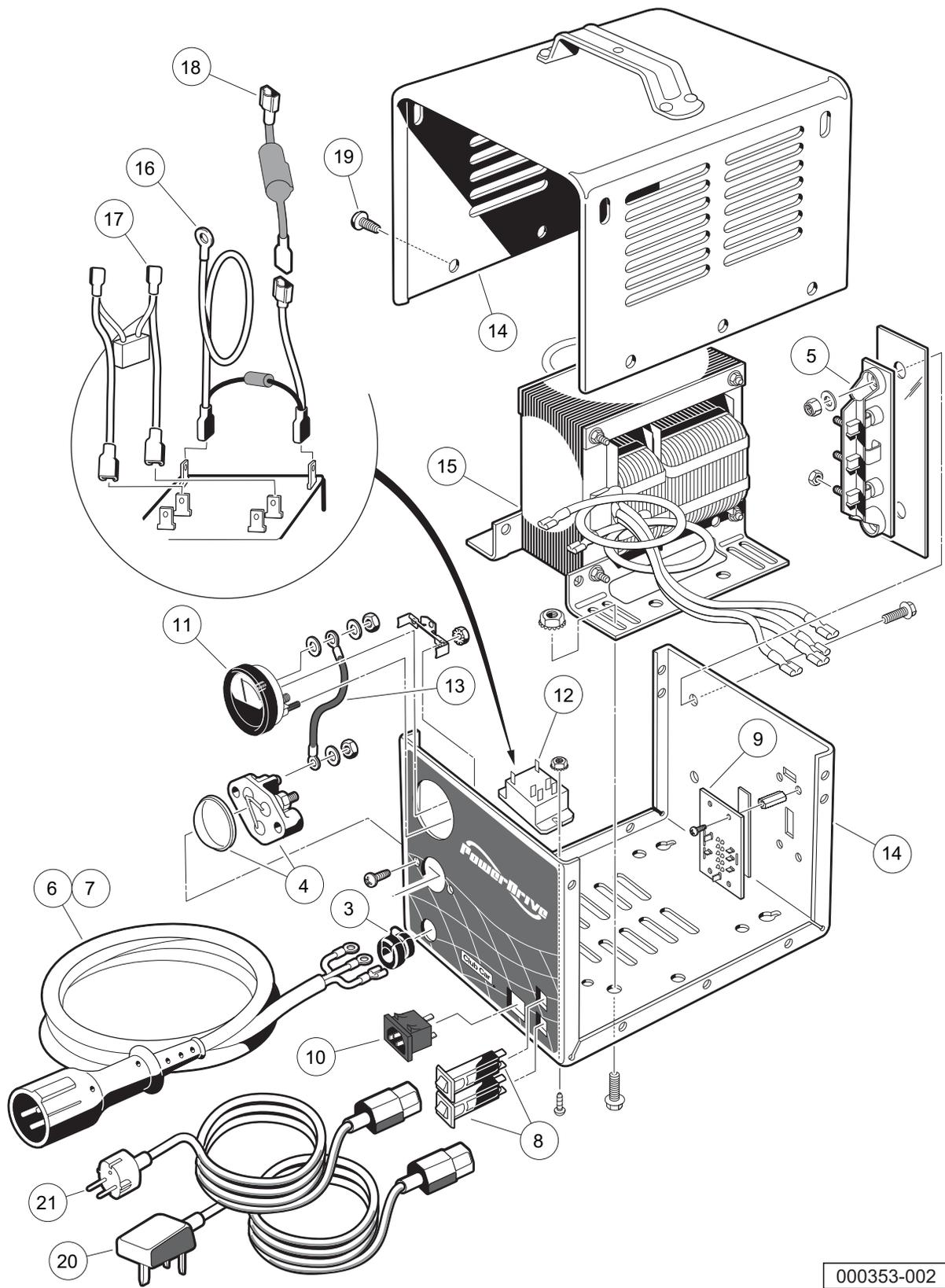

000353-002

POWERDRIVE BATTERY CHARGER (MODEL 20310), EUROPEAN

17

E

ITEM	PART NO.	DESCRIPTION	QTY
		1 2 3 4	
1	<u>101956201</u>	Battery Charger, 48-Volt w/ 4-Position Switch (8.5-ft DC)	1
2	<u>101956202</u>	Battery Charger, 48-Volt w/ 4-Pos. Switch (12-ft DC) (includes items 3 through 19)	1
3	<u>1012098</u>	Bushing, DC Cord	1
4	<u>1012101</u>	Fuse Assembly	1
5	<u>1015914</u>	Rectifier with Heatsink Assembly	1
6	<u>101828901</u>	Cord, DC, 113-Inch (287 cm)	1
7	<u>101828902</u>	Cord, DC, 154-Inch (391 cm)	1
8	101838401	Circuit Breaker	2
9	101838601	Four-Position Switch	1
10	101973501	Receptacle, AC Cord	1
11	101976601	Ammeter with Mounting Bracket	1
12	<u>101987501</u>	Relay	1
13	N/A	Wire, Jumper	1
14	N/A	Case, Charger	1
15	****	Transformer, European Battery Charger	1
16	****	Suppressor, AC Voltage	1
17	****	Assembly, Wire	1
18	N/A	Limiter, Current	1
19	7577	Screw, #10 X 0.50 Phillips Pan-Head	10
20	<u>101958201</u>	Cord, UK, AC, Battery Charger	1
21	101958301	Cord, European AC, Battery Charger	1
<p>**** Special order item available upon request.</p> <p>Note: Level 1 Battery Charger part numbers include one AC and one DC cord. They do not include all of the level 2 cords listed.</p>			

17

E

MAINTENANCE AND SERVICE TOOLS

18

G

E

18
G
E

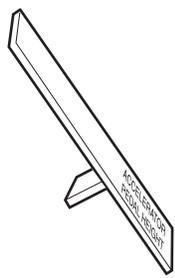

1



2



3

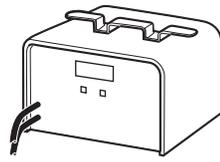

4



5



6

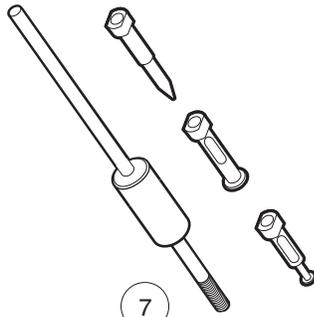

7

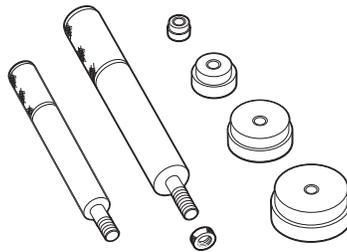

8



9

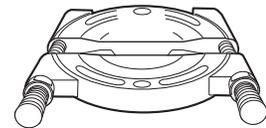

10



11

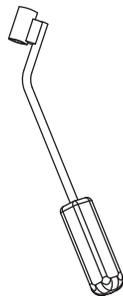

12



13

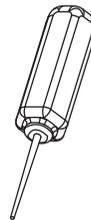

14



15

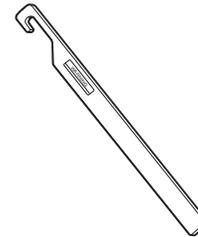

16



17



18

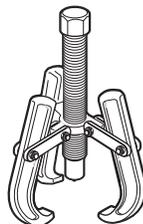

19



20



21

001600-001

MAINTENANCE AND SERVICE TOOLS

ITEM	PART NO.	DESCRIPTION	QTY GAS	QTY ELEC
		<p style="text-align: center;">1 2 3 4</p> <p>The following tool list includes all tools available from Club Car to perform maintenance and service procedures on all electric utility vehicles and all gasoline utility vehicles equipped with Kawasaki FE-series engines. Be sure to carefully examine the tool list for applicability to your vehicle before ordering.</p>		
1	<u>101871001</u>	Accelerator Pedal Adjustment Tool (Utility Vehicles).....	1	1
2	<u>101813202</u>	Adhesive, Guide Ring, 3-Gram Tube		1
3	<u>101641202</u>	Arbor	1	
4	<u>101831901</u>	Battery Discharge Machine, 36/48 Volt		1
5	<u>1014305</u>	Battery Terminal Protector Spray	1	1
6	1011767	Battery Thermometer	1	1
7	<u>1016417</u>	Bearing and Oil Seal Remover Assembly	1	1
8	<u>1016416</u>	Bearing Driver Set	1	1
9	<u>1012811</u>	Bearing Puller	1	1
10	<u>1012812</u>	Bearing Puller Wedge Attachment	1	1
11	1013582	Brake Adjustment Tool (used only on vehicles with manually adjusted mechanical brakes)	1	1
12	<u>102555501</u>	Brake Cable Release Tool	1	1
13	<u>101887101</u>	Calibration Test Module		1
14	<u>102562401</u>	Charger Bezel Tool		1
		Clutch Tools (items 14 - 20)	1	
15	<u>101808401</u>	Clutch Cam Installation Tool (for Kawasaki engines)	1	
16	<u>1015524</u>	Drive Clutch Holder Tool Assembly (for Kawasaki engines)	1	
17	<u>1014497</u>	Drive Clutch Hub Puller (for Kawasaki engines)	1	
18	<u>1014496</u>	Drive Clutch Puller (for Kawasaki engines)	1	
19	<u>1014508</u>	Driven Clutch Cam Puller (for Kawasaki engines)	1	
20	<u>1014507</u>	Driven Clutch Puller Plug (for Kawasaki engines)	1	
21	<u>101809101</u>	Press Weldment (for Kawasaki engines)	1	
		<p>Please refer to the maintenance and service manual for proper tool application.</p>		

18

G

E

18
G
E

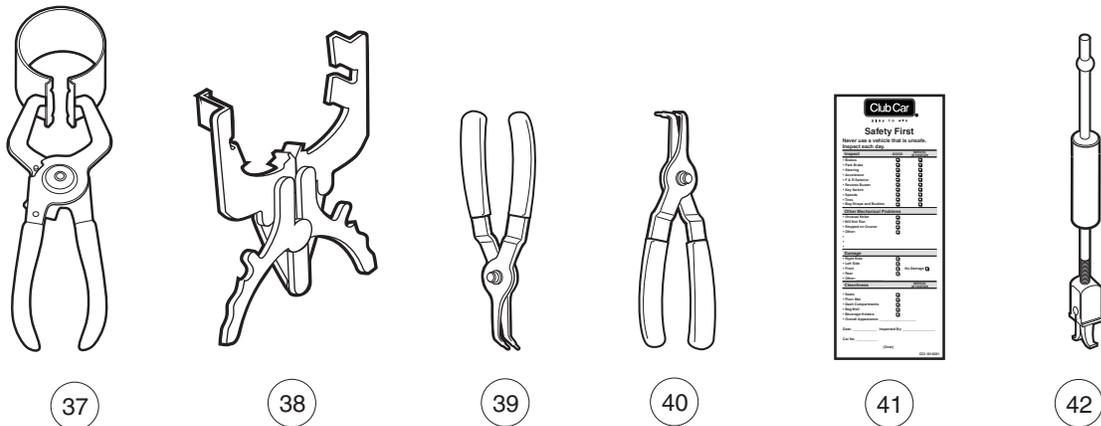
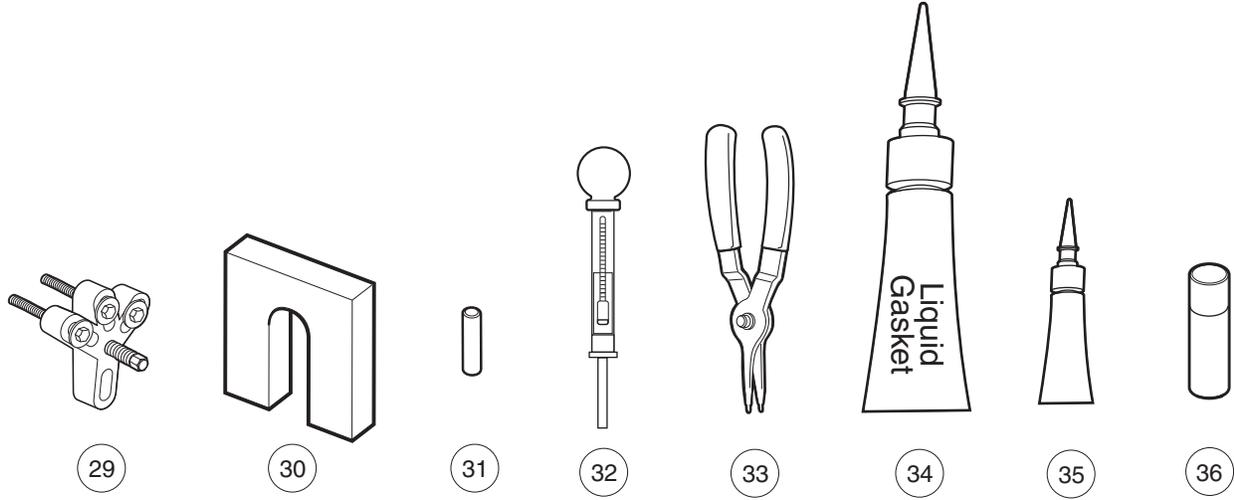
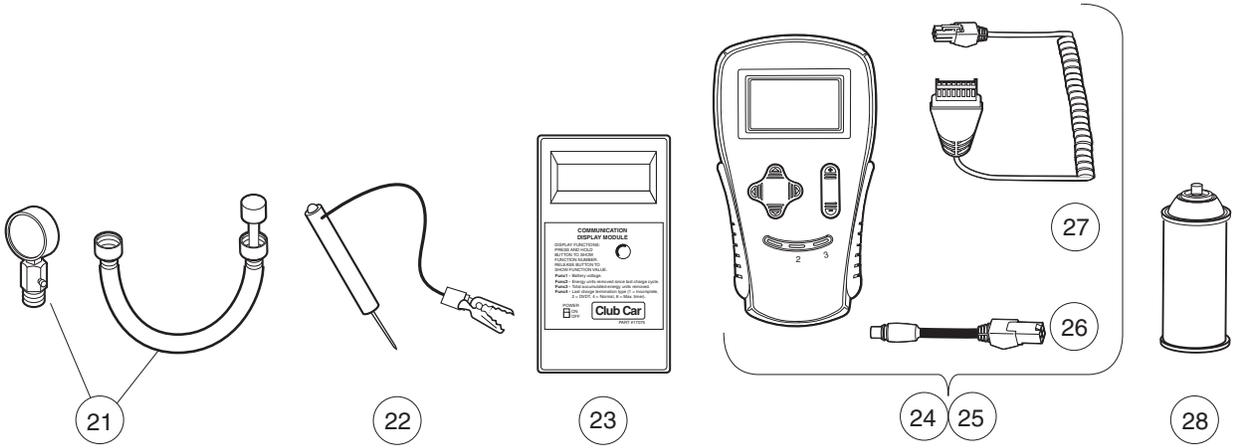

001601-001

MAINTENANCE AND SERVICE TOOLS, CONTINUED

ITEM	PART NO.	DESCRIPTION	QTY GAS	QTY ELEC
		1 2 3 4		
21	101641002	Compression Gauge and Adapter	1	
22	1011273	Continuity Tester	1	1
23	101831801	Communication Display Module		1
24	<u>102248803</u>	IQ Display Module (IQDM) Kit (IQ System and IQ Plus vehicles) (includes items 54 and 55)		1
25	102248804	IQ Display Module (IQDM-P) Kit (IQ System and IQ Plus vehicles)..... (includes items 54 and 55)		1
26	<u>102251501</u>	Adaptor, Cable		1
27	<u>102241502</u>	IQDM Series 2 Cable		1
28	<u>1012151</u>	Dry Moly Lubricant	1	1
29	<u>1016627</u>	Flywheel Puller Kit (for Kawasaki Engines)	1	
30	<u>1016418</u>	Gear Yoke	1	1
31	<u>101933101</u>	Governor Shaft Installation Tool (for Kawasaki Engine Vehicles)	1	
32	<u>1011478</u>	Hydrometer	1	1
33	<u>1013593</u>	Internal Retaining Ring Pliers	1	1
34	<u>101928701</u>	Liquid Gasket (transaxle case)	1	1
35	<u>102243402</u>	Moly-Teflon Lubricant (4-oz. (113-gram) tube)		1
36	<u>101997201</u>	Paint, Touch-Up ,Äi Beige*	1	1
36	<u>101997207</u>	Paint, Touch-Up ,Äi Black*	1	1
36	<u>101997212</u>	Paint, Touch-Up ,Äi Burgundy*	1	1
36	<u>101997211</u>	Paint, Touch-Up ,Äi Classic Blue (Navy)*	1	1
36	<u>101997205</u>	Paint, Touch-Up ,Äi Dark Gray*	1	1
36	<u>101997209</u>	Paint, Touch-Up ,Äi Dark Green*	1	1
36	<u>101997204</u>	Paint, Touch-Up ,Äi Gray*	1	1
36	<u>101997203</u>	Paint, Touch-Up ,Äi Red*	1	1
36	<u>101997206</u>	Paint, Touch-Up ,Äi Royal Blue (Pacific Blue)*	1	1
36	<u>101997202</u>	Paint, Touch-Up ,Äi White*	1	1
37	<u>1016414</u>	Piston Ring Compressor Kit	1	
38	<u>1016415</u>	Piston Ring Pliers	1	
39	<u>1012549</u>	Retaining Ring Pliers, 45→ External	1	1
40	<u>1012560</u>	Retaining Ring Pliers, 90→ Internal	1	1
41	<u>101823101</u>	Safety First Card (50 per pack)	1	1
42	<u>1012809</u>	Seal Puller	1	1
		Please refer to the maintenance and service manual for proper tool application.		

18
G
E

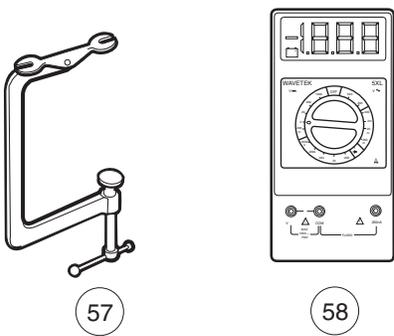
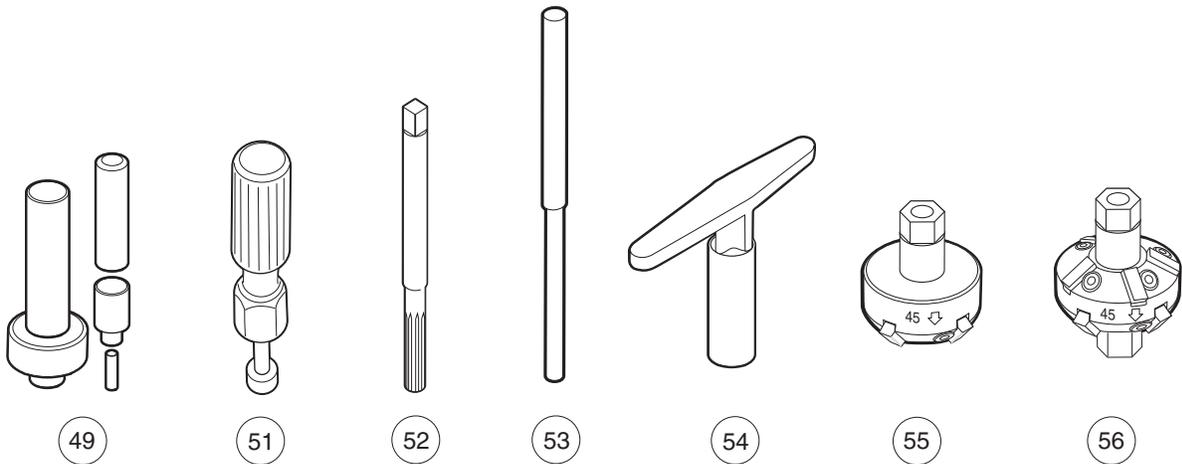
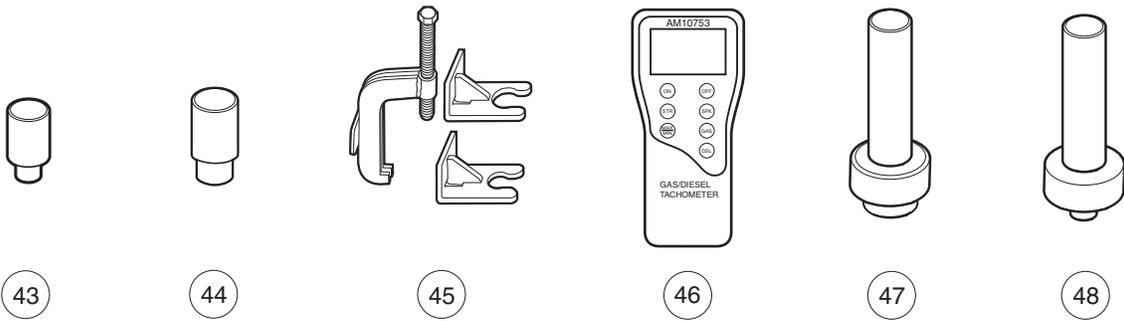

001602-001

MAINTENANCE AND SERVICE TOOLS, CONTINUED

ITEM	PART NO.	DESCRIPTION	QTY GAS	QTY ELEC
		1 2 3 4		
43	<u>1014264</u>	Steering Column Bearing Press Tool	1	1
44	<u>1014259</u>	Steering Column Retaining Ring Tool	1	1
45	102061201	Steering Wheel Puller Tool	1	1
46	<u>AM10753</u>	Tachometer (includes gasoline engine pick up lead only)	1	
47	<u>1014162</u>	Transaxle Axle Seal Tool (for electric vehicles)		1
48	1014161	Transaxle Pinion Seal Tool (for electric vehicles)		1
49	<u>1014115</u>	Transmission Tool Kit (for electric vehicles).....		1
50	<u>101611003</u>	Tune-Up Kit, All OHV (for FE290, FE350, FE400 only) (includes air filter, spark plug, oil filter, fuel filters) (not shown)	1	
51	<u>1016413</u>	Valve Clearance Adjuster Screw Holder (for FE290 engines only)	1	
52	101641201	Valve Guide Reamer (FE290, FE350, and FE400 only).....	1	
53	<u>1016552</u>	Valve Seat Cutter Guide	1	
54	<u>1016551</u>	Valve Seat Cutter T-Wrench	1	
55	<u>1016553</u>	Valve Seat Cutter, 45→× (32 mm diameter) (for FE290 engines only)	1	
56	<u>1016554</u>	Valve Seat Cutter, 45→×/30→× (35 mm diameter)	1	
57	<u>101641101</u>	Valve Spring Compressor	1	
58	1011480	Volt Ohm Meter	1	1
		Please refer to the maintenance and service manual for proper tool application.		

18
G
E

INDEX

Part Number and Page

AM10753	18-7	8056	4-11	1011478	18-5
AM10080	13-9	8057	4-11, 13-3	1011480	18-7
AM10081	13-9	8058	13-3	1011557	4-5, 4-7
AM10419	12-9	8067	6-13	1011578	1-31, 6-5
AM10724	8-5, 9-5	8104	4-9	1011582	4-35
AM1243501	4-29	8233	1-3, 1-23, 1-25, 1-29, 1-33, 4-25, 4-27, 4-31, 4-33, 5-5, 5-7, 10-3, 13-3, 13-5, 13-7, 13-13, 14-3	1011590	4-9
AM1243701	4-25, 4-27, 4-29	8248	10-3, 13-3, 14-3	1011652	1-27
AM1243801	4-25, 4-27, 4-29	8251	1-23, 1-25, 13-5	1011694	5-5, 5-7
CCX8506	17-3, 17-5, 17-7	8294	4-31	1011697	6-5, 9-15, 10-11, 10-15, 14-11
183	4-5, 4-7, 4-9, 4-23, 4-29, 10-17, 12-3, 13-7, 13-13	8450	12-3	1011734	5-9
304	1-31, 4-31	8639	4-29, 14-13	1011767	18-3
320	1-21, 1-31, 1-33	8717	5-7, 7-9, 13-3, 13-7, 13-13	1011779	5-13
324	4-25, 4-27	8754	1-21, 5-5, 5-7, 5-13, 6-5, 6-7, 6-9, 6-11, 6-15, 7-13, 7-15	1011825	4-31
332	1-3, 1-23, 1-25, 1-27, 1-33, 4-25, 4-27, 4-31, 10-17, 11-3, 11-5, 13-5, 14-3, 14-13	8755	1-33, 6-9, 6-15	101187702	5-3
334	1-33, 5-5, 5-7, 6-5, 6-7, 8-15, 9-15	8797	10-5	1011895	6-7
357	6-9	8861	6-11	1011930	6-7
451	11-3, 11-5, 15-3, 15-5	8990	4-9, 4-21, 4-27, 4-33, 6-7, 7-9, 14-3, 14-13	1011931	1-29, 5-5, 5-7
705	7-13, 7-15, 8-15, 9-15	1010124	6-9	1011988	10-3
706	6-9	1010138	1-31, 6-11	1011990	1-21
808	12-3	1010145	6-15	1012098	17-3, 17-5, 17-7, 17-9, 17-11
1016	4-5, 4-9, 4-23	1010150	6-9	1012101	17-7, 17-9, 17-11
1017	4-3, 7-7	1010436	1-17	1012151	18-5
1028	5-3	1010543	1-27	1012285	4-33, 10-15, 13-5, 14-3, 14-13
1032	5-3	1010545	1-31	1012295	7-9
1035	6-7	1010577	8-15, 9-15	1012303	1-33, 6-9, 6-15
1241	1-5, 1-7, 1-29, 4-5, 4-7, 5-3, 5-5, 5-7, 5-13, 7-9, 7-13, 7-15, 7-17, 11-3, 11-5, 15-3	1010805	5-3	1012304	6-15
1242	4-21, 5-13, 7-9, 7-13, 7-15, 14-13	1010829	5-13	1012328	7-17
1606	10-17	1010850	5-11	1012333	13-5
1620	4-3	1010877	5-3	1012396	4-13
1624	5-5, 5-7, 6-7	1010878	1-33, 5-3	1012412	1-23, 1-25
2402	6-11	1010909	4-5, 4-23	1012431	4-11, 13-3
4029	4-31	1010921	5-3	1012438	4-7, 4-29
7048	6-13	1010927	5-3	1012467	6-7
7173	1-5, 4-5, 4-7, 7-17	1010932	5-3	1012505	4-13
7174	6-5, 7-13, 7-15, 10-15, 11-3, 11-5, 14-13, 15-3, 15-5	1010933	5-3	1012528	11-3, 11-5, 14-13
7310	2-3	1010934	7-17, 15-3, 15-5	1012549	18-5
7311	1-29	1010954	7-9, 13-3, 13-7, 13-13	1012560	18-5
7330	13-11, 16-3	1010984	2-3	1012571	8-15, 9-15
7335	13-9, 16-3	1010993	1-23, 1-25	1012594	13-3
7336	16-3	1011084	5-9	1012604	6-5
7473	4-5, 4-7, 5-3, 5-5, 5-7, 5-13, 7-9, 7-17	1011229	4-5, 4-7	1012605	6-5
7540	6-7	1011273	18-5	1012649	10-3
7555	6-7	1011280	4-5, 4-7, 15-3	1012711	13-7
7577	17-5, 17-7, 17-9, 17-11	1011285	15-3	1012714	13-9
7591	4-5, 4-7	1011290	15-3	1012740	13-9
7602	6-7	1011291	13-11	1012741	13-9
7716	5-3, 5-5, 5-7	1011382	4-13	1012747	13-9
7818	7-9	1011402	5-3	1012748	13-9
7820	4-31	1011411	15-3	1012752	13-7
7847	1-23, 1-25, 1-29, 1-33, 4-35, 11-3, 11-5	1011415	6-15	1012809	18-5
7893	4-5, 4-9, 4-23, 7-9, 13-5	1011418	5-3	1012811	18-3
		1011439	4-5, 4-7	1012812	18-3
		1011466	5-11	1012830	7-13, 7-15, 10-15, 11-3, 11-5
				1012836	12-9
				1012896	13-7
				1012986	4-15

INDEX

1012987	13-3	1014058	12-3	1015072	14-11
1013001	7-11	1014059	12-3	1015137	10-5, 10-11, 10-13
1013003	7-11	1014062	12-3	1015139	10-3, 10-5
1013005	7-11	1014063	12-3, 14-13	1015143	10-3, 10-5
101301102	7-11	1014065	7-9, 12-3, 13-3	1015153	4-25
101303202	1-9	1014070	12-9	1015154	4-25
1013035	6-7	1014072	12-9	1015156	4-25, 4-27, 4-29
1013042	6-7, 6-11	1014078	12-9	1015157	4-25, 4-27
1013044	6-7	1014080	12-9	1015160	4-25, 4-27
1013052	6-7	1014089	13-3	1015162	4-25
1013061	13-7, 13-13, 14-9	1014115	18-7	1015167	4-29
1013164	6-15	1014116	10-3	1015170	4-29
1013357	4-5, 4-7	1014119	7-9	1015172	4-25, 4-27
1013461	7-7, 10-5	1014125	6-5	1015187	4-25, 4-27, 4-29
1013462	10-5	1014126	6-5	101524001	7-13
1013494	4-13	1014145	7-9, 13-3	101524002	7-15
1013509	4-25, 4-27	1014153	5-11	1015330	8-9, 11-3
1013531	5-13	1014161	18-7	1015332	8-3, 9-3
1013547	4-33	1014162	18-7	1015345	7-9
1013579	4-33	1014201	15-3, 15-5	1015371	7-9
1013582	18-3	1014207	13-11	1015372	7-9
1013587	13-3	1014213	6-5	1015373	7-9
1013589	7-9, 13-3	1014214	6-5	1015391	1-31
1013590	13-3	1014217	6-5	1015405	7-9
1013591	13-3	1014259	18-7	1015426	10-17
1013593	18-5	1014264	18-7	101547601	3-5
1013609	7-9	1014276	6-9	1015524	18-3
1013687	10-3	1014287	12-3	1015526	4-25, 4-27, 4-29
1013700	10-15	1014288	6-5, 7-17, 12-3, 14-13	1015528	4-13
1013734	11-3, 11-5, 14-13	1014289	7-11	1015583	1-33, 6-15
1013746	10-3, 10-5, 10-11, 10-13	1014304	14-11	101558302	6-9
1013760	13-7	1014305	18-3	1015597	6-7, 6-13
1013768	13-11	1014306	1-23, 1-25, 4-33	1015649	8-3, 9-3
1013769	13-11	1014375	7-17	1015737	7-9
1013770	13-11	1014453	12-3	1015741	4-5, 4-7, 7-9
1013771	13-11	1014454	12-9	1015752	4-35, 7-9, 10-17, 14-5
1013772	13-11	1014496	18-3	1015765	4-25
1013773	13-11	1014497	18-3	1015768	4-29
1013774	13-11	1014507	18-3	1015770	4-29
1013787	13-11	1014508	18-3	1015814	11-3, 11-5
1013792	13-11	1014530	4-31	101584502	10-15
1013794	13-11, 16-3	1014540	4-33	1015914	17-3, 17-7, 17-9, 17-11
1013857	4-15, 4-17	101454902	6-15	1015917	17-7, 17-9
1013869	5-3	1014555	6-15	1015921	10-5
1013870	5-3	1014573	6-15	1015932	7-13, 7-15
1013871	5-5, 5-7	1014675	6-15	1015969	8-3, 9-3
1013876	1-31, 5-3	1014727	13-3	1016004	10-5
1013924	5-11, 8-15, 9-15	1014807	13-3	1016074	7-13, 7-15
1013983	1-19	1014901	6-15	1016103	10-11
1014007	5-5, 5-7, 13-7, 13-13	1014902	6-15	101611003	18-7
1014049	12-3	1014928	10-3	101611402	16-5
1014050	12-3	1014947	14-13	1016183	6-5
1014052	12-3	1014948	7-9	1016201	12-3, 13-3
1014055	12-3	1015010	4-29	1016203	12-5
1014056	12-3	101503202	1-3	1016230	4-29
1014057	12-3	1015064	13-3	1016267	4-29

INDEX

1016269	6-5	1016451	8-9	1016531	8-3, 9-3
1016287	4-29	1016452	8-9, 9-7	1016532	8-13
1016289	12-3	1016453	8-11	1016533	8-13
1016337	13-9	1016454	8-11, 9-9	1016535	8-11, 9-9
1016338	13-9	1016455	8-5, 9-5	1016536	8-3
1016342	13-3	1016456	8-3, 8-5, 8-11, 9-3, 9-5	1016537	8-7, 9-13
1016346	6-11	1016457	8-7, 9-13	1016538	8-11, 9-9
1016349	6-11	1016458	8-9, 8-11, 9-7	1016539	8-3, 9-3
1016350	6-11	101645901	8-13	1016541	8-13, 9-11
1016351	6-11	101645902	8-13	1016542	8-9
1016353	6-11	101645903	8-13	1016544	8-5, 8-9, 8-11, 9-5, 9-7, 9-9
1016356	4-5, 4-7	1016460	8-13	1016545	8-9
1016363	4-7	101646101	8-13	1016546	10-15
1016365	4-21	101646102	8-13	1016547	8-3, 8-13, 9-3, 9-11, 10-11, 10-13
1016366	4-7	101646103	8-13	1016548	8-5
1016384	6-9	1016467	8-7, 9-13	1016549	8-9, 9-7
1016385	6-11	1016469	8-13	101655001	8-13
1016386	6-9	1016470	8-13, 9-11	101655002	8-13
1016387	6-9	1016471	8-9	101655003	8-13
1016389	6-9	1016472	8-11, 9-9	101655004	8-13
101641002	18-5	1016473	8-7, 9-13	101655005	8-13
101641101	18-7	1016474	8-9, 9-7	101655006	8-13
101641201	18-7	101647501	8-13	101655007	8-13
101641202	18-3	101647502	8-13	101655008	8-13
1016413	18-7	1016479	8-9, 9-7	101655009	8-13
1016414	18-5	1016480	10-11, 10-13	1016551	18-7
1016415	18-5	101648102	10-11, 10-13	1016552	18-7
1016416	18-3	101648203	8-7, 9-13	1016553	18-7
1016417	18-3	1016483	8-9, 9-7	1016554	18-7
1016418	18-5	1016484	8-7	1016558	8-13
1016423	4-5, 4-7, 7-9	1016486	10-7, 10-9	1016559	8-13
101642572	10-7	1016489	8-9, 9-7	1016560	8-9, 9-7
101642575	10-7, 10-9	101649002	10-11, 10-13	1016561	8-5, 9-5
101642578	10-7, 10-9	1016493	8-5	1016562	8-5, 8-13, 9-5, 9-11
101642580	10-7, 10-9	1016494	8-11, 9-9	1016563	8-9, 9-7
101642582	10-7, 10-9	1016496	8-11, 9-9	1016564	8-11, 9-9
101642585	10-9	1016497	8-5, 9-5	1016565	8-11
1016429	8-7, 9-13	1016499	10-7, 10-9	1016566	8-9, 9-7
1016430	8-9	1016501	10-7, 10-9	1016567	8-11
1016431	8-9	1016502	8-7, 9-13	1016568	8-13
1016432	8-7, 9-13, 13-7	1016505	8-5	1016569	8-9, 9-7
1016435	8-7	1016506	8-11, 9-9	1016570	8-7, 9-13
1016436	8-9, 9-7	1016507	8-3, 9-3	1016571	8-13, 9-11
1016437	10-7, 10-9	1016509	8-13	1016572	10-11, 10-13
1016438	10-11, 10-13	1016510	8-11, 9-9	1016576	8-7, 9-13
1016439	10-11	1016513	13-7	1016578	8-5, 9-5
1016440	8-9, 9-7, 10-11, 10-13	1016516	8-13	1016579	8-5, 9-5
1016441	10-11, 10-13	1016517	8-9, 9-7	1016580	8-13
1016443	8-3	1016518	9-7	1016581	8-7, 9-13
1016444	10-11, 10-13	1016519	8-9, 9-7	1016582	10-11, 10-13
1016445	8-5, 9-5	1016520	8-11	1016583	8-9, 9-7
1016446	8-9, 8-11	1016521	8-11, 9-9	1016584	8-11, 9-9
1016447	8-9	1016523	8-9	1016585	10-7, 10-9
1016448	8-9	1016524	8-3	1016586	8-5, 9-5
1016449	8-9, 9-7	1016525	8-3	1016587	8-5, 9-5
1016450	8-9, 9-7	1016526	8-3	1016588	8-5, 9-5

INDEX

1016627	18-5	1017455	8-5, 9-5	1017949	15-3
1016630	4-13, 4-15	1017456	8-7, 9-13	1017950	15-3
1016672	13-11	101745701	9-11	1017953	15-3
1016717	4-35	101745702	9-11	101795701	14-7, 14-11
1016801	12-3	1017458	9-13	101796201	5-5, 5-7
1016837	4-25, 4-27	1017460	9-13	101796501	14-9
1016849	4-13	1017461	10-7, 10-9	101796801	14-9
1016851	4-11, 4-13	1017463	9-5	101801001	14-9
1016879	4-3, 7-7	1017466	10-11, 10-13	101802101	14-9
1016880	4-3, 7-7	1017468	8-5, 9-5	101802201	17-7
1016883	7-13, 7-15	1017471	9-11	101802202	17-7
1016901	12-3	1017472	9-9	101802203	17-7
1016904	9-7, 11-5	1017473	9-7	101802204	17-5
1016916	1-27	1017474	9-3	101802205	17-5
1016929	4-25, 4-27, 4-29	1017475	9-3	101802206	17-5
1016947	13-3	1017476	9-3	101804301	4-13, 10-17
1016952	1-23, 1-25	1017486	9-3	101805701	10-17
1017029	5-3	1017487	9-9	101806901	1-9
1017062	4-3, 7-7	1017490	9-5	101808401	18-3
1017064	4-3, 7-7	1017500	9-3	101809101	18-3
1017065	4-3, 7-7	1017501	9-11	101810501	4-7
101707402	4-9	1017502	9-11	101811401	10-17
1017075	4-9	1017503	9-11	101811501	10-17
1017082	13-7, 13-13	1017504	9-9	101811901	10-17
1017141	1-23, 1-25	1017507	8-7, 9-13	101812301	10-17
1017188	12-7	1017508	9-9	101813001	10-17
1017203	10-3	1017510	9-11	101813202	18-3
1017221	8-3	1017512	9-11	101814601	4-27
1017226	6-5	1017513	9-9	101815501	5-11
1017231	13-7	1017514	9-9	101815502	5-11
1017235	6-15	101751801	9-9	101816301	5-11
1017266	6-11	101751802	9-9	101816501	5-11
1017273	6-3	101751803	9-9	101816502	5-11
1017313	6-5	1017653	7-11	101817401	5-5, 5-7
1017314	6-5	1017686	12-9	101818801	5-7
1017315	6-5	1017689	11-3, 11-5	101819701	17-7
1017317	6-5	1017696	5-5, 5-7	101820201	10-11
1017378	5-5, 5-7	1017705	14-9	101821501	10-17
1017380	5-5, 5-7	1017721	4-5, 4-23	101821601	4-29
1017424	5-5, 5-7	1017724	4-9	101823101	18-5
1017434	9-7	101773301	9-11	101823201	5-11
1017435	9-7	101773302	9-11	101823301	5-11
1017442	9-13	101773303	9-11	101823302	5-11
1017443	9-7, 9-9	101773304	9-11	101823801	5-11
1017444	9-7	101773305	9-11	101823901	5-11
1017445	9-7	101773306	9-11	101824001	5-11
1017446	9-7	101773307	9-11	101824002	5-11
1017447	9-9	101773308	9-11	101824401	10-3, 10-5
1017448	8-5, 9-5	101773309	9-11	101826301	4-13
101744901	9-11	101773310	9-11	101826801	14-13
101744902	9-11	101773311	9-11	101827101	8-15, 9-15
1017450	9-11	1017774	1-29	101827801	14-13
101745101	9-11	1017853	4-5, 4-7	101828301	17-7
101745102	9-11	101791101	5-11	101828501	17-7, 17-9
1017453	9-11	1017944	15-3	101828601	17-5
1017454	9-7	1017947	15-3	101828801	17-5, 17-7

INDEX

101828802	17-5, 17-7	101875001	7-11	101892501	13-9
101828901	17-7, 17-9, 17-11	101875101	7-11	101892601	13-9
101828902	17-7, 17-9, 17-11	101875102	7-11	101892701	13-11
101828903	17-7	101875201	7-11	101892901	13-7
101828904	17-5	101875301	7-11	101893201	13-9
101828905	17-5	101875401	7-11	101893801	13-7
101828906	17-5	101875501	7-11	101893901	13-9
101830601	4-13	101875601	7-11	101894901	14-9
101830701	4-13, 4-17	101875701	7-11	101895401	16-3
101831101	17-7	101875802	7-11	101895501	16-3
101831503	17-9	101876001	7-11	101896501	7-11
101831504	17-9	101876202	7-11	101896901	10-5
101831701	17-9	101876301	7-11	101897001	16-3
101831702	17-9	101876402	7-11	101897201	16-3
101831801	18-5	101876501	7-11	101897401	16-3
101831901	18-3	101877601	7-11	101897601	16-3
101832001	14-9	101877701	7-11	101898001	7-17
101832101	8-15	101878101	7-11	101903001	14-7
101832202	10-15	101878201	5-3	101903101	6-9
101832302	10-15	101878302	6-7	101903601	16-3
101832601	9-15	101879001	7-11	101903701	16-3
101832701	8-15, 9-15	101879401	6-7	101905601	10-7
101833101	9-15	101879501	6-7	101905901	10-9
101833201	8-15	101879601	6-7	101906901	16-3
101833401	12-9	101879701	6-7	101908101	14-3
101833601	13-7	101879801	6-7	101908401	14-3
101833701	7-11	101879901	6-7	101908601	3-11
101833906	12-3	101880001	6-7	101908703	14-13
101834001	12-9	101880101	6-7	101909201	8-5, 9-5
101834502	4-13	101880201	6-7	101909301	8-5, 9-5
101834601	8-15, 9-15	101880301	6-7	101909401	8-5, 9-5
101834801	13-7, 13-13	101881101	8-5, 9-5	101909501	8-5, 9-5
101835601	1-33, 4-21, 4-35	101881501	4-33	101909701	8-3
101836201	12-9	101881601	4-33	101910401	1-29, 14-13
101837101	10-17	101881701	10-17	101910501	13-11
101837301	7-13, 7-15	101884801	8-15, 9-15	101912401	5-9
101838201	17-9	101886101	13-7, 13-13	101914001	16-5
101838301	17-9	101887101	18-3	101914401	4-5, 17-7, 17-9
101838401	17-9, 17-11	101887601	8-3, 9-3, 10-11	101915201	3-5
101838501	17-9	101889401	13-9	101915401	8-11
101838601	17-9, 17-11	101890001	13-9	101915501	8-13
101838701	17-9	101890101	13-7	101915601	8-3
101850301	10-17	101890201	13-7	101915801	8-5
101851101	4-13	101890501	13-7	101916001	9-11
101855002	14-3	101890601	13-7	101916101	9-3
101855801	1-23, 1-25, 13-5	101890901	13-11	101916201	9-5
101856002	14-3	101891001	13-11	101916301	9-5
101856102	7-9	101891301	13-7	101916701	7-13, 7-15, 12-3
101856201	10-17	101891401	13-11	101917601	10-17
101859301	11-3	101891501	13-11	101917701	10-17
101859401	11-5	101891601	13-9	101918501	5-3
101861901	5-5, 5-7	101891901	13-9	101919801	5-5, 5-7
101862001	5-5	101892001	13-9	101920101	14-3, 14-5, 15-3, 15-5
101869302	7-11	101892201	13-9	101921501	10-17
101871001	18-3	101892301	13-9	101922101	16-3
101874901	7-11	101892401	13-9	101922201	16-3

INDEX

101922301	8-13	101972003	18-5	102044801	4-15
101922501	14-3	101972004	18-5	102045001	1-3
101922601	13-5	101972005	18-5	102048401	1-3
101923001	16-3	101972006	18-5	102051601	4-15
101923201	16-3	101972007	18-5	102051701	4-15, 4-17
101923501	16-3	101972009	18-5	102051901	4-15, 4-17
101923901	16-3	101972011	18-5	102061201	18-7
101925701	10-17	101972012	18-5	102065901	1-33, 8-15, 9-15
101926501	6-15	101972101	16-3	102066201	5-13
101926901	13-7, 13-19	101972201	16-3	102101001	14-5
101927101	13-7	101972801	10-17	102101101	14-5
101927201	13-7	101973101	10-7, 10-9	102155801	12-9
101927301	13-7	101973201	10-7	102158901	5-5, 5-7
101927501	13-9	101973301	10-9	102174201	1-27
101927601	13-9	101973401	10-13	102174202	1-27
101927701	13-9	101973501	17-11	102174204	1-27
101927901	13-9	101976601	17-11	102174205	1-27
101928001	13-9	101978001	14-7	102186001	15-5
101928101	13-9	101978101	14-7	102186101	15-5
101928301	13-11	101978201	14-7	102186201	15-5
101928601	13-7	101978601	16-5	102186401	15-5
101928701	13-7, 16-3, 18-5	101979101	13-3	102186701	15-5
101929301	8-5	101980801	13-9	102186901	15-5
101929401	6-15	101980901	13-9	102187001	15-5
101929802	12-3	101981001	13-9	102187101	15-5
101931501	3-11, 14-13	101984801	6-5	102187201	15-5
101932201	4-5, 4-7	101985502	1-27	102196901	14-3, 14-7
101932401	14-3	101987501	17-11	102198001	4-15, 4-17
101932501	14-3	101987602	1-27	102198701	4-5
101932601	14-13	101987701	10-3	102199001	4-5
101932701	14-13	101987901	4-3, 7-7	102199201	4-5
101932902	13-19	101988001	4-3, 7-7	102199301	4-5
101933101	18-5	101988002	4-3, 7-7	102199401	4-5
101936101	16-5	101988101	4-3, 7-7	102199601	14-7
101936801	14-5	101988201	4-3, 7-7	102221201	1-23, 1-25
101939901	7-11	101990703	4-15	102235201	15-3, 15-5
101942301	14-3, 15-3, 15-5	101990801	5-13	102240104	15-3
101951501	13-5	101991101	4-15	102240501	14-13
101953101	5-13	101997802	4-33	102241502	18-5
101953802	9-3	101997803	4-33	102242101	1-7, 12-9
101953901	8-3	101997902	4-33	102243101	14-13
101954301	1-3, 1-27	101997903	4-33	102243402	18-5
101955101	4-31	101998211	1-27	102243403	15-3, 15-5
101956201	17-11	101998212	1-27	102248803	18-5
101956202	17-11	101998214	1-27	102251501	18-5
101957101	4-5, 4-7	101998215	1-27	102259801	14-13
101958201	17-11	101998501	1-27	102263601	14-7, 14-13
101958301	17-11	102003201	10-3	102263701	14-13
101960501	1-9, 3-5	102022101	5-13	102264001	7-9
101963401	7-9, 8-15, 9-15	102022601	6-11	102265601	15-3
101965205	14-13	102022602	6-11	102265701	15-3
101968701	14-7	102025801	1-3	102265801	15-3
101969701	4-31	102025901	4-15	102265901	15-3
101971301	10-17	102026001	5-5, 5-7	102266001	15-3
101972001	18-5	102031901	13-11	102266101	15-3
101972002	18-5	102044702	4-15	102266601	14-3

INDEX

102266701	14-3	102529201	4-9	102810501	14-7
102267001	15-3	102540301	8-15, 9-15	102815801	2-3
102273201	17-5	102544201	1-29	102815901	2-3
102273301	17-5	102555501	18-3	102816201	1-29
102273401	17-5	102562401	18-3	102818301	1-25
102273501	17-5	102572401	14-7	102818302	1-25
102273601	17-5	102581201	1-29	102818303	1-25
102273701	17-3, 17-5	102588501	6-15	102818305	1-25
102273801	17-3, 17-5	102618601	1-11, 1-13	102819101	2-3
102273901	17-3, 17-5	102704701	15-5	102820301	1-33
102274001	17-5	102704801	15-5	102820501	1-33
102278001	6-5	102704901	15-5	102821101	1-33
102278801	3-9, 3-15	102705001	15-5	102822001	1-3
102289001	1-33	102711201	7-9	102822002	1-3
102289002	1-11, 1-13	102751601	10-5	102822401	6-3
102289201	6-11	102753401	8-9, 9-7	102823201	1-33
102289301	1-33	102766701	1-3	102825401	3-7
102292801	5-13	102771701	16-3	102825402	3-7
102296530	1-29	102777401	14-11	102825501	3-13
102298240	1-11, 1-13	102777601	1-23, 1-25	102825502	3-13
102304701	8-9	102777602	1-23, 1-25	102825601	3-7
102304801	9-7	102778501	1-3	102825701	3-13
102310701	1-19	102778502	1-3	102828701	1-3, 1-17
102323101	5-3	102778503	1-3	102829703	1-21
102323201	5-3	102778504	1-3	102829704	1-21
102336001	10-15	102778505	1-3	102829802	1-21
102336101	10-15	102778507	1-3	102830201	1-13
102352201	4-21	102778509	1-3	102830401	6-9
102353201	6-13	102778601	1-3	102830501	1-11
102353301	6-13	102778901	1-31	102830701	1-31
102353401	6-13	102779001	1-31	102830801	4-17
102354104	6-13	102779201	1-31	102831901	3-3, 3-13
102354204	6-13	102779301	1-31	102832001	3-3, 3-13
102354901	4-21	102779401	1-31	102832601	14-11
102355001	4-21	102779501	1-31	102833301	3-3, 3-11
102355102	1-21	102779601	1-31	102838401	9-5
102355301	7-17	102796101	1-29	102840301	1-29
102356601	16-3	102796201	6-3	102850801	3-9
102356801	16-3	102796301	1-29	102850901	3-9
102357501	4-21	102796302	1-29	102851001	3-15
102357701	6-13	102796501	1-17	102851101	3-15
102406701	10-3	102796701	1-3	102851201	3-9
102430901	9-11	102796801	1-23	102851301	3-9
102431001	9-9	102796802	1-23	102851401	3-15
102453001	13-9	102796803	1-23	102851501	3-15
102453101	13-9	102796804	1-23	102852401	1-13
102499001	4-17	102796805	1-23	102852501	4-35
102503221	1-29	102797201	1-33	102857401	1-3
102503222	1-29	102803001	7-5	102861401	2-5
102503224	1-29	102804501	4-15	102865101	10-3
102508601	4-17	102804502	4-15	102869401	4-5, 4-7
102508701	4-17	102804503	4-17	102886301	16-3
102511301	14-11	102804504	4-17	102886401	16-3
102511302	14-11	102806201	14-13	102886501	16-3
102515401	13-7, 13-13	102806203	14-13	102886601	16-3
102522001	10-5	102810301	1-15	102896801	13-13

INDEX

102896901	13-13	102902701	13-17	103428701	17-3
102897201	13-15	102902801	13-17, 16-3	103428801	17-3
102897301	13-15	102909901	4-35	103429001	17-3
102897401	13-13	102911601	4-35	103429101	17-3
102897501	13-13	102913101	1-29	103429201	17-3
102897601	13-13	102913102	1-29	103429301	17-3
102897701	13-15	102913601	6-9	103429501	17-3
102897801	13-13	102914301	1-3	103429601	17-3
102897901	13-13	102952301	10-5	103429701	17-3
102898001	13-15	102959401	1-17	103434001	17-3
102898101	13-15	102967901	1-3, 4-15, 4-17	103439901	17-3
102898201	13-13	102977001	4-13	103477901	6-13
102898301	13-15	103010101	10-3	103499101	17-3
102898401	13-15	103180101	4-13	103499102	17-3
102898501	13-15	103189901	1-31	103499103	17-3
102898601	13-15	103199001	4-13	103502601	6-9
102898701	13-15	103199101	4-13	103507001	6-9
102898801	13-15	103200701	4-17	103520301	10-17
102898901	13-15	103218601	14-7	103582801	16-3
102899001	13-15	103255601	4-5	103601601	6-5
102899101	13-13	103255701	4-7	103628701	6-9
102899201	13-13	103256901	4-5	103651902	10-3
102899301	13-15	103257001	4-7	103653501	6-11
102899401	13-13	103257603	4-19	103653601	6-11
102899501	13-15	103257701	4-19	103776902	10-3
102899601	13-15	103257801	4-19	103781101	10-3
102899701	13-13	103293501	1-31	96704416	8-15, 9-15
102899801	13-13	103313301	1-5, 1-7		
102899901	13-15	103316701	14-13	A	
102900001	13-13	103316801	14-13	absorber, rear shock	6-15
102900101	13-13	103316901	14-13	AC cord	17-3, 17-5, 17-7, 17-9, 17-11
102900201	13-13	103317501	1-31	AC cord bushing	17-3, 17-5
102900301	13-13	103325501	15-3	AC cord receptacle	17-11
102900401	13-15	103325601	15-3	accelerator bracket and bearing assembly	5-5, 5-7
102900501	13-15	103325701	15-3	accelerator cable	10-15
102900601	13-13	103325801	15-3	accelerator pedal	5-5, 5-7
102900701	13-15	103337601	15-3	accelerator pedal adjustment tool	18-3
102900801	13-17	103344501	1-15	accelerator pivot rod	5-5, 5-7
102900901	13-13	103345701	12-3	accelerator return spring	5-5, 5-7
102901001	13-15	103348201	4-13	accelerator rod	5-9
102901101	13-15	103348202	4-19	accessory receptacle	4-15, 4-17
102901201	13-17	103348501	4-13	adapter	
102901301	13-17	103348601	4-13	cable (IQDM)	18-5
102901401	13-17	103351001	6-11	adhesive, guide ring	18-3
102901501	13-17	103354401	4-19	adjuster, lash	9-9
102901601	13-17	103354701	6-11	air box	10-17
102901701	13-17	103372101	10-3	air box top	10-17
102901801	13-17	103372302	10-3	air filter	10-17
102901901	13-17	103377201	5-13	air intake hose	10-17
102902001	13-17	103377301	5-13	ammeter	17-3, 17-5, 17-7, 17-9, 17-11
102902101	13-17	103379501	13-5	angled bumper mount	6-15
102902201	13-17	103397901	4-7, 17-7	A-plate strap	6-11
102902301	13-17	103403101	14-13	A-plate, delta	6-11
102902401	13-17	103414901	4-7, 17-7	arbor	18-3
102902501	13-17	103428501	17-3	arm	
102902601	13-17	103428601	17-3		

INDEX

governor 13-7, 13-13
pivot 13-7
rocker 8-9, 9-7
armature 7-11, 15-3, 15-5
armature conversion kit 7-11
armrest 1-27
assembly
 accelerator bracket and bearing 5-5, 5-7
 accelerator pivot rod 5-5, 5-7
 air box 10-17
 air box top 10-17
 armature 7-11
 axle 13-11
 bearing, steering shaft 6-5
 bell crank and shaft 7-9
 brake lever 5-11
 brush connector 7-11
 brush holder 7-11
 carburetor 10-7, 10-9
 connecting rod 8-13, 9-11
 cylinder head 9-7
 delta A-plate 6-11
 delta shock and gear support 6-11
 drive hub 12-3
 driven clutch 12-9
 driven clutch fixed-face 12-9
 field coil 7-11
 float 10-7, 10-9
 Forward/Reverse shifter 13-3
 frame and field (motor) 15-5
 fuel cap 10-3
 fuel pump 10-3
 fuel tank vent 10-3, 10-5
 governor 13-9, 13-15
 headlight 4-3, 7-7
 headlight harness 4-3, 7-7
 idle screw 10-7, 10-9
 inner ball joint 6-7
 kingpin 6-9
 moveable-face 12-3, 12-9
 pilot air screw 10-7, 10-9
 plug cap 9-5
 ratchet 5-3
 secondary clutch weight 12-3
 steering shaft 6-5
 turn signal lens 4-3, 7-7
axle 13-7, 13-11, 13-17, 16-3
axle guard 13-19, 16-5
axle shaft oil seal 13-11, 13-17, 16-3
axle tube 13-11, 13-17, 16-3

B

backing plate, brake 5-11
backrest, beige 1-29
backrest, gray 1-29
backrest, white 1-29

ball bearing 9-9
ball joint 5-3, 5-9, 6-7, 13-5
ball joint, left-hand thread 6-7
ball stud 7-9, 13-3, 13-7, 13-13
ball, bearing 6-13
ball, shifter 13-9
ball, steel pressure relief 8-7, 9-13
band, RPM limiter mount 8-5, 9-5
bar, drive 14-5
barb, vent 10-3, 10-5
battery charger 17-3, 17-5, 17-7, 17-9, 17-11
battery charger case 17-3, 17-5, 17-7, 17-9, 17-11
battery charger handle 17-5
battery charger receptacle 14-9
battery charger transformer 17-5, 17-7, 17-9, 17-11
battery clamp 7-17
battery condition indicator 4-19
battery condition indicator kit 4-19
battery condition indicator, 48-volt 4-17
battery discharge machine 18-3
battery hold-down, 12-volt 14-11
battery light 4-17
battery terminal protector spray 18-3
battery thermometer 18-3
battery, 12-volt 7-17
battery, 12-volt, Trojan T1275, moist 14-11
battery, 12-volt, Trojan T1275, wet 14-11
bearing 16-3
 ball 6-13, 9-9
 ball (motor) 15-5
 ball (steering pinion) 6-7
 cage roller 13-15
 idler 12-3
 inner axle tube 13-11, 16-3
 lower pinion (steering) 6-7
 needle 13-9
 outer axle tube 13-11
 pivot support 5-5, 5-7
 steering shaft 6-5
 thrust 6-9
bearing and oil seal remover 18-3
bearing driver set 18-3
bearing puller 18-3
bearing puller wedge 18-3
bearing retainer 15-3
bearing seat 6-5
bed support 1-29
bed support stiffener 1-33
bed, cargo 1-31
bell crank 13-3
bell crank and shaft 7-9
bellows 6-7
belt, drive 12-5, 12-7
belt, starter/generator 7-13, 7-15, 12-3

belt, V 7-13, 7-15, 12-3
bezel, headlight 4-3, 7-7
block, brake-mounting 5-3
block, fuse 4-5, 4-7, 7-9
block, terminal 4-5, 4-7
body kick plate 1-23, 1-25
body, front 1-3
body, rear 1-23, 1-25
bolt, J- 14-11
bolt, U- 6-15
boot, steering column 6-5
boot, switch 14-3
bottom, air box 10-17
box
 air 10-17
 dash 1-15
 differential 13-17
 electrical component 7-9
 glove 1-17
 steering gear 6-7
box lock kit, glove 1-17
brace, canopy 1-5, 1-7
brace, seat support cross 1-29
bracket 4-15, 6-15, 8-3
 accelerator cable 10-15
 adjustable starter/generator 7-13, 7-15
 brake light switch 4-5, 4-7
 governor cable 10-15
 headlight mounting 4-3, 7-7
 horn 4-31
 hour meter 4-33
 muffler mounting 11-3, 11-5
 oil filter mount 8-7, 9-13
 oil level switch 8-11, 9-9
 relay mounting 17-9
 RPM limiter 8-5, 9-5
 shifter 13-5
 snubber 8-15, 9-15
 starter/generator mounting 7-13, 7-15
 steering column 6-5
 steering column mounting 6-5
 throttle spring return 10-11, 10-13
 Tow/Run switch 14-3
brake adjusting mechanism 5-11
brake adjustment tool 18-3
brake backing plate 5-11
brake cable 5-13
brake cable equalizer 5-13
brake cable release tool 18-3
brake cluster 5-11
brake drum 5-11
brake lever 5-11
brake light switch bracket 4-5, 4-7
brake mounting block 5-3
brake pedal 5-3
brake pedal pad 5-3

INDEX

- brake relay kit, 12-volt 4-5
- brake return spring 5-13
- brake self-adjusting mechanism 5-11
- brake shoe 5-11
- brake spring 5-11
- breaker, circuit 17-3, 17-5, 17-7, 17-9, 17-11
- breather 13-7, 13-13, 16-3
- brush 15-3, 15-5
- brush and screw set 7-11
- brush box assembly 15-5
- brush connector 7-11
- brush cover kit, starter/generator 7-11
- brush guard 1-13
- brush guard support 6-9
- brush holder 7-11
- brush inspection port cover 7-11
- brush plate
 - starter/generator 7-11
- brush port cover 7-11
- brush rigging 15-3, 15-5
- brush spring 15-3, 15-5
- brush spring set 7-11
- brush spring, starter/generator 7-11
- brush terminal, starter/generator 7-11
- bulb, headlight 4-3, 7-7
- bulb, strobe light 4-25, 4-27, 4-29
- bulb, tail light 4-35
- bumper
 - cast 1-11
 - drive unit (motor) 15-3, 15-5
 - jounce 6-15
 - rubber 1-17, 1-33, 5-3
 - side trim 1-19
 - spring return 5-5, 5-7
- bumper mount, angled 6-15
- bushing 7-9, 12-3, 13-3
 - AC cord 17-3, 17-5
 - bronze 6-13
 - nylon 5-3
 - return line 10-3
 - spindle 6-13
 - steel 1-33, 6-9, 6-15
 - urethane 1-33, 6-9, 6-11, 6-15
- bushing, insulated 15-3
- button, choke 10-17
- button, drive 12-9
- buzzer, reverse 4-11, 4-13
- C**
- cable
 - accelerator 10-15
 - brake 5-13
 - governor 10-15
 - transmission 13-5
- cable retainer 1-23, 1-25, 13-5
- cable, cargo bed 1-31
- calibration test module 18-3
- cam
 - driven clutch 12-9
 - electrical component box 7-9
 - neutral lockout 13-3
- cam, neutral lockout 13-3
- camshaft 8-11, 9-9
- camshaft shim 9-9
- canopy brace 1-5, 1-7
- cap
 - dust 14-3, 14-7
 - front hub 6-13
 - fuel tank 10-5
 - fuel, gas, ratchet 10-3
 - key switch 4-13
 - plug 9-5
 - spark plug 8-5
- carburetor 10-7, 10-9
- carburetor gasket 10-13
- carburetor insulator 10-11, 10-13, 15-3
- carburetor mounting gasket 10-11, 10-13
- card, safety first 18-5
- cargo bed 1-31
- cargo bed hinge 1-33
- case
 - battery charger 17-3, 17-5, 17-7, 17-9, 17-11
 - differential gear 13-11
 - FNR switch 14-3
 - gear 13-7, 13-13, 16-3
 - rocker 8-9, 9-7
- cast bumper 1-11
- catch, tilt bed 1-31
- CE mark controller 14-13
- center, steering wheel 6-3
- charger
 - wire assembly kit 17-7
- charger bezel tool 18-3
- charger hardware kit 17-3
- charger receptacle 14-9
- charger wires 17-3
- charger, battery, PD2 17-5
- charger, battery, PD3 17-3
- charger, battery, PowerDrive 17-7
- charger, battery, PowerDrive European 17-11
- charger, battery, PowerDrive Export 17-9
- choke button 10-17
- choke lever 10-17
- choke lever guide 10-17
- choke positioner 10-17
- choke valve 10-17
- circuit breaker 17-3, 17-5, 17-7, 17-9, 17-11
- clamp
 - battery 7-17
 - cable retaining 10-15
 - hose 10-3, 10-5, 10-11, 10-13, 10-17
 - muffler hose 11-3, 11-5
- clevis, upper delta 6-9
- clip
 - meter 4-13
- cluster idler gear 13-9
- cluster, brake 5-11
- clutch cam installation tool 18-3
- clutch pulley 12-3
- clutch repair kit 12-9
- clutch tool kit 18-3
- clutch weight 12-3
- clutch, drive 12-3
- clutch, driven 12-9
- coil, field 7-11
- coil, ignition 8-5, 9-5
- collet 8-9, 9-7
- column, steering 6-5
- communication display module 18-5
- component box, electrical 7-9
- component mounting plate 14-13
- compression gauge 18-5
- compression lug 14-13
- compression spring 10-17
- compressor, piston ring 18-5
- compressor, valve spring 18-7
- computer, onboard 14-13
- conduit 4-29
- connecting rod 8-13, 9-11
- connector, a- 7-11
- connector, four-pin 14-3
- continuity tester 18-5
- controller cover 14-13
- controller cover gasket 14-13
- controller, motor speed
 - IQ 14-13
- controller, motor speed (CE) 14-13
- converter, DC/DC 4-21
- cord connector 8-11, 9-9
- cord set, DC 17-3, 17-5
- cord, AC 17-3, 17-5, 17-7, 17-9, 17-11
- cord, DC 17-7, 17-9, 17-11
- counterbalance guide shaft 8-13, 9-11
- counterbalance weight 8-13, 9-11
- cover
 - brush inspection port 7-11
 - brush port 7-11
 - cowl 1-3
 - crankcase 8-11, 9-9
 - dust 5-11
 - electrical box 7-9
 - fuse block 4-7
 - oil pump 8-7, 9-13
 - rocker switch hole 4-13
 - screw head 4-13
 - steering column 6-5
- cover gasket, controller 14-13

INDEX

cover plate 15-5
cover, controller 14-13
cover, speed controller 14-13
cover, steering column 4-9
cowl 1-3
cowl cover 1-3
cowl support 1-3
crank, bell 13-3
crankcase 8-13, 9-11
crankcase cover 9-9
crankcase cover gasket 8-9, 8-11
crankcase vent tube 10-11, 10-13
crankshaft 8-13, 9-11
crankshaft rod 9-11
crankshaft seal 8-11
crankshaft shim 8-13, 9-11
cross brace, seat support 1-29
C-type stop ring 6-7
cup, spring 5-5, 5-7
current limiter 17-11
cushion, shock absorber 6-15
cutter, valve seat 18-7
cylinder head 9-7

D

damper, RPM limiter 8-5, 9-5
dash 1-3
dash box 1-15
dash panel 4-13
DC cord 17-7, 17-9, 17-11
DC cord set 17-3, 17-5
DC/DC converter 4-21
decal
 800 3-9
 810 3-9
 810E 3-15
 Club Car 3-9, 3-15
 component cover 3-11, 14-13
 crush area 3-3, 3-13
 crush warning 3-3, 3-13
 driver/passenger 3-5
 frame ground 3-5
 instrument panel warning 3-7, 3-13
 operating instructions 3-7, 3-13
 owner notice 3-3, 3-11
 rotating parts 1-9, 3-5
 Tow/Run switch warning 3-11
delta A-plate 6-11
delta A-plate sub-assembly 6-11
delta shock and gear support 6-11
DF-terminal insulator 7-11
diagnostic port 14-7
differential drive unit 13-7, 16-3
differential gear 13-11, 16-3
differential gear case 13-11, 13-17
differential guard 13-19, 16-5

differential housing 16-3
differential idler gear 13-11
differential pin 13-11
diode 7-9
diode, rectifier 17-5
dipstick 8-3, 9-3
drain plug 8-7, 9-13, 13-13
drain plug gasket 8-7, 9-13, 13-7, 13-13
drive bar 14-5
drive belt 12-5, 12-7
drive button 12-9
drive clutch 12-3
drive clutch button 12-3
drive clutch fixed-face 12-3
drive clutch holder tool 18-3
drive clutch hub puller 18-3
drive clutch puller 18-3
drive clutch spring 12-3
drive clutch weight 12-3
drive hub 12-3
drive selector shaft 13-7, 13-13
drive unit bumper 15-3, 15-5
drive unit guard 13-19, 16-5
driven clutch 12-9
driven clutch button 12-9
driven clutch cam 12-9
driven clutch cam puller 18-3
driven clutch fixed-face assembly 12-9
driven clutch puller plug 18-3
driver, drive clutch 12-3
drum, brake 5-11
dry moly lubricant 18-5
dust cap 14-3, 14-7
dust cover 5-11

E

eccentric bolt 6-9
E-clip 5-13
electrical box cover 7-9
electrical component box 7-9
end bell, commutator 7-11
end bell, output shaft 7-11
end cap, motor 15-3, 15-5
end shield
 motor 15-3
end, tie rod 6-11
engine 8-3, 9-3
engine mounting plate 8-15, 9-15
engine shroud 8-3, 9-3
engine valve spring 8-9
equalizer rod 5-13
equalizer, brake cable 5-13
exhaust system 11-3, 11-5
exhaust valve 8-9, 9-7
extension, spring latch 1-31
extrusion, cover support 14-13

F

face, moveable 12-3, 12-9
fan housing 8-3, 9-3
fan shroud 8-3, 9-3
fan, flywheel 8-5, 9-5
fender 1-23, 1-25
field coil 7-11
field coil housing 7-11
fill plug 13-7, 13-13
fill plug gasket 13-13
filter
 air 10-17
 fuel 10-3
 oil 8-7, 9-13
 oil pump 9-13
fitting, thread-forming grease 6-7, 6-13
fixed-face, drive clutch 12-3
fixed-face, driven clutch 12-9
float 10-7, 10-9
floor mat 1-3
flywheel 8-5, 9-5
flywheel fan 9-5
flywheel fan plate 8-5, 9-5
flywheel puller 18-5
FNR closeout brush 4-13
FNR handle 13-3
FNR shift lever 13-7, 13-13
FNR shifter base 13-3
FNR switch case 14-3
foam, seat 1-27
fork, shift 13-9, 13-15
Forward/Reverse shifter 13-3
frame and field assembly (motor) 15-5
frame and field, starter/generator 7-11
front body 1-3
front body support 1-23, 1-25
front hub 6-13
front spring retainer plate 6-9
F-terminal hardware 7-11
f-terminal insulator 7-11
fuel filter 10-3
fuel gauge sending unit 10-5
fuel gauge/hour meter 4-15
fuel line 10-3, 10-5, 10-11, 10-13
fuel meter 4-13
fuel pump 10-3
fuel tank 10-5
fuel tank cap 10-5
fuel tank strap 10-3
fuel tank vent 10-3, 10-5
fuse 14-9, 17-7, 17-9, 17-11
 10-amp 7-9
 20-amp 4-5, 4-7, 7-9
 3/8-amp 14-9
 charger 17-3, 17-5

INDEX

fuse block 4-5, 4-7, 7-9
fuse block cover 4-7

G

gasket
carburetor 10-13
carburetor mounting 10-7, 10-9, 10-11, 10-13
crankcase cover 8-9, 8-11, 9-7, 9-9
drain plug 8-7, 9-13, 13-7
drain plug, fill plug 13-13
exhaust 8-9, 9-7, 11-3, 11-5
head 8-9, 9-7
insulator 8-9, 9-7, 10-11, 10-13
liquid 13-7, 16-3, 18-5
oil pump 8-7
plug 16-3
rocker case 8-9, 9-7
seat 1-27
sending unit 10-5
taillight 4-35
gasket kit, FE290 8-9
gasket kit, FE350 9-7
gasket, controller cover 14-13
gauge, battery condition 4-19
gauge, compression 18-5
gauge, fuel/hour 4-15
gauge, fuel-hour 4-13
gear
25 tooth 13-15
28 tooth 13-15
case 13-13
cluster idler 13-9
differential 13-11, 13-17, 16-3
differential idler 13-11, 16-3
differential output 16-3
helical 8-13, 9-11, 13-9, 13-11
planetary 13-17
speed governor 13-15
spur 8-13, 9-11, 13-9
sun 13-17
synchro 13-9
gear yoke 18-5
gearcase 13-7, 16-3
glove box 1-17
glove box lock 1-17
glove box lock kit 1-17
governor 13-9, 13-15
governor arm 13-7, 13-13
governor cable 10-15
governor cable bracket 10-15
governor shaft installation tool 18-5
governor shield 10-11
grommet 10-3, 10-5
ignition 8-5, 9-5
guard, brush 1-13

guard, differential 13-19, 16-5
guide

choke lever 10-17
intake valve 8-9, 9-7
valve 9-7
valve seat cutter 18-7

guide ring adhesive 18-3

H

handle, battery charger 17-5
handle, FNR 13-3
hardware kit, charger 17-3
hardware, F-terminal 7-11
harness, headlight 4-5, 4-7
harness, wire 4-21, 4-25, 4-27, 4-35, 14-7
gasoline 7-5
harness, wire, lighting 4-7
head gasket 8-9, 9-7
head, cylinder 9-7
head, FE290 8-9
headlight 4-3, 7-7
headlight assembly 4-3, 7-7
headlight bulb 4-3, 7-7
headlight harness 4-3, 7-7
headlight retainer 4-3, 7-7
headlight wire harness 4-5, 4-7
heatsink 17-5
heatsink and rectifier 17-3, 17-7, 17-9, 17-11
helical gear 8-13, 9-11, 13-9, 13-11
hill brake rod 5-3
hill brake weld assembly 5-3
hinge plate 1-23, 1-25, 1-27
hinge support 1-33
hinge, cargo bed 1-33
hold-down, battery, 12-volt 14-11
holder, object 1-3
horn 4-31
horn bracket 4-31
horn button and wire assembly 4-31
hose
fuel 10-3
hose, air intake 10-17
hour meter 4-13, 4-33
hour meter, 36-48 volt 4-33
hour meter/fuel gauge 4-15
housing
2-pin 14-5
3-pin 14-3, 14-5, 15-3, 15-5
4-pin 14-3
6-pin 14-13
differential 16-3
fan 8-3, 9-3
field coil 7-11
hub 6-13
hub and spindle 6-13
hub cap 6-13

hub, front 6-13
hub, synchronizer clutch 13-9
hydrometer 18-5

I

idle screw assembly 10-7, 10-9
idler bearing 12-3
idler gear, differential 16-3
ignition coil 8-5, 9-5
indicator, battery condition 4-19
inner frame snubber 8-15, 9-15
input shaft 16-3
insert, synchronizer 13-9
instrument panel 4-13, 4-15, 4-17
insulated bushing 15-3
insulator gasket 8-9, 9-7, 10-11, 10-13
insulator, carburetor 10-11, 10-13, 15-3
intake pipe 10-11, 10-13
intake valve 8-9, 9-7
intermediate shaft 16-3
internal retaining ring pliers 18-5
IQ display module (IQDM) 18-5

J

J-bolt 14-11
jet, main 10-7, 10-9
jet, pilot 10-7, 10-9
joint
ball 5-3, 5-9, 13-5
left-hand thread ball 6-7
jounce bumper 6-15

K

key 4-17
crankshaft 8-5, 8-13, 9-5, 9-11
driven clutch 12-9
On/Off 4-13
square 12-9
starter/generator 7-11
woodruff 13-7
key (pair) 4-15
key switch 4-13, 4-15, 4-17
key switch cap 4-13
key switch spacer 4-15
keyswitch nut 4-15, 4-17
kick plate, body 1-23, 1-25
kingpin 6-9
kit
2-pin housing 14-5
3-pin housing 14-3, 14-5, 15-3, 15-5
4-pin housing 14-3
6-pin housing 14-13
accelerator pivot rod 5-5, 5-7
air duct repair tape 10-17
armature conversion 7-11

INDEX

- battery condition indicator 4-19
 - brake cable 5-13
 - brake pedal 5-3
 - brake relay 4-5
 - brake shoe retainer 5-11
 - clutch repair 12-9
 - differential gear case 13-11
 - drive clutch button 12-3
 - drive clutch weight 12-3
 - driven clutch button 12-9
 - fixed-face drive 12-3
 - flywheel puller 18-5
 - front hub replacement 6-13
 - fuel tank 10-5
 - gasket, FE350 9-7
 - hour meter 4-33
 - IQ display module (IQDM) 18-5
 - magnet and bearing 15-3
 - motor brush 15-5
 - motor brush spring 15-5
 - motor cover plate 15-5
 - motor speed sensor 15-5
 - motor terminal hardware 15-5
 - neutral lockout cam 13-3
 - park brake latch 5-3
 - park brake pedal 5-3
 - PD3 hardware 17-3
 - PD3 wiring 17-3
 - piston ring compressor 18-5
 - relay, 48V 4-7, 17-7
 - shock absorber 6-15
 - shock absorber cushion 6-15
 - shoe retainer 5-11
 - steering column mounting bracket 6-5
 - strobe light 4-25, 4-27, 4-29
 - transmission tool 18-7
 - tune-up 18-7
 - turn signal 4-9
 - wire assembly, charger 17-7
- knob, light switch 4-15, 4-17
- ## L
- lamp, strobe light 4-25, 4-27, 4-29
 - lamp, turn signal and socket 4-9
 - lash adjuster 9-9
 - lash spring 1-31
 - latch, air box 10-17
 - latch, park brake 5-3
 - L-bracket, motor 15-5
 - leaf spring 6-15
 - lens, headlight 4-3, 7-7
 - lens, strobe light 4-25, 4-27, 4-29
 - lens, taillight 4-35
 - lever
 - choke 10-17
 - drive selector 13-7
 - speed governor 13-13
 - transmission shift 13-7, 13-13
- ## light
- battery 4-17
 - oil 4-13, 4-15
 - tail 4-35
- ## light switch
- 4-15, 4-17
- ## light switch knob
- 4-15, 4-17
- ## light, strobe
- 4-25, 4-27, 4-29
- ## limit switch
- 4-5, 4-7, 13-3
- ## limiter
- current 17-11
 - RPM 8-5, 9-5
 - voltage 4-5, 4-7, 4-23
- ## line, fuel
- 10-5, 10-11, 10-13
- ## link, rack and pinion drag
- 6-7
- ## link, rod
- 1-31
- ## liquid gasket
- 13-7, 16-3, 18-5
- ## lock kit, glove box
- 1-17
- ## lock, glove box
- 1-17
- ## low oil warning light
- 4-13, 4-15
- ## lubricant, dry moly
- 18-5
- ## lubricant, moly-teflon
- 15-3, 15-5, 18-5
- ## lug nut
- 2-3
- ## lug stud
- 6-13, 13-11, 13-17, 16-3
- ## lug, compression
- 14-13
- ## M
- magnet and bearing kit 15-3
 - magnet, speed sensor 15-3, 15-5
 - main jet 10-7, 10-9
 - main nozzle 10-7
 - mat, floor 1-3
 - MCOR 14-5
 - mechanism, brake adjusting 5-11
 - meter clip 4-13
 - meter, hour 4-33
 - meter, volt ohm 18-7
 - module
 - calibration test 18-3
 - communication display 18-5
 - moly-teflon lubricant 18-5
 - motor
 - 48-volt 15-3
 - 48-volt IQ 15-5
 - motor armature 15-3
 - motor brush 15-3
 - motor brush kit 15-5
 - motor brush spring kit 15-5
 - motor bumper 15-3, 15-5
 - motor end cap 15-3, 15-5
 - motor end shield 15-3
 - motor L-bracket 15-5
 - motor magnet, speed sensor 15-3, 15-5
 - motor speed controller
 - CE 14-13
- ## IQ
- 14-13
- ## motor speed sensor
- 15-3, 15-5
- ## motor speed sensor kit
- 15-5
- ## motor stator shell and winding
- 15-3
- ## motor terminal hardware kit
- 15-5
- ## mounting block, brake
- 5-3
- ## moveable-face
- 12-3, 12-9
- ## muffler hose clamp
- 11-3, 11-5
- ## N
- needle bearing 13-9
 - nerf bar 1-21
 - neutral lockout cam 13-3
 - non-skid tape 1-21
 - nozzle, main 10-7, 10-9
 - nut, keyswitch 4-15, 4-17
 - nut, lug 2-3
- ## O
- OBC 14-13
 - object holder 1-3
 - oil conveyor 13-13
 - oil filler tube 8-3, 9-3
 - oil filter 8-7, 9-13
 - oil filter mount bracket 8-7, 9-13
 - oil filter screen 8-11, 9-9
 - oil filter screen plate 8-11, 9-9
 - oil level sensor 8-11, 9-9
 - oil level switch bracket 8-11, 9-9
 - oil pump and rotor 8-7, 9-13
 - oil pump cover 8-7, 9-13
 - oil pump filter 9-13
 - oil pump gasket 8-7
 - oil pump plate 8-7, 9-13
 - oil seal 8-9, 8-13, 9-7, 9-9, 9-11, 13-7, 13-9
 - oil warning light, low 4-13, 4-15
 - onboard computer 14-13
 - O-ring 8-3, 8-9, 8-11, 8-13, 9-3, 9-7, 9-9, 9-11
 - overload bumper spacer 6-15
- ## P
- pad
 - accelerator pedal 5-5, 5-7
 - brake pedal 5-3
 - park brake 5-3
 - wear 1-23, 1-25
 - paint, touch-up 18-5
 - panel
 - instrument 4-15
 - panel, instrument 4-13, 4-15, 4-17
 - park brake latch 5-3
 - park brake pedal 5-3
 - park brake rod sleeve 5-3
 - park brake spacer 5-3
 - park brake torsion spring 5-3

INDEX

- pawl 5-3
 - pedal, accelerator 5-5, 5-7
 - pedal, brake 5-3
 - pedal, park brake 5-3
 - pilot air screw 10-7
 - pilot air screw assembly 10-9
 - pilot jet 10-7, 10-9
 - pin
 - bow tie locking 5-13
 - clevis 5-13
 - differential 13-11
 - piston 9-11
 - pin, piston 8-13
 - pinion, steering 6-7
 - pipe, intake 10-11, 10-13
 - piston 8-13, 9-11
 - piston pin 9-11
 - piston ring 8-13, 9-11
 - piston ring compressor 18-5
 - piston ring pliers 18-5
 - piston ring set 9-11
 - pivot arm 13-7
 - pivot support bearing 5-5, 5-7
 - plate
 - backing (brake) 5-11
 - body kick 1-23, 1-25
 - component mounting 14-13
 - cover 15-5
 - engine mounting 8-15, 9-15
 - flywheel fan 8-5, 9-5
 - front spring retainer 6-9
 - hinge 1-23, 1-25, 1-27
 - oil filter screen 8-11, 9-9
 - oil pump 8-7, 9-13
 - receptacle backing 14-9
 - spring mounting 6-9
 - thrust 13-9, 13-11
 - pliers
 - internal retaining ring 18-5
 - piston ring 18-5
 - retaining ring 18-5
 - plug
 - 4-pin 14-3
 - 6-pin 14-13
 - drain 8-7, 9-13, 13-13
 - driven clutch puller 18-3
 - fill 13-7, 13-13
 - spark 8-5, 9-5
 - plug cap 9-5
 - pole set 7-11
 - port, diagnostic 14-7
 - positioner, choke 10-17
 - press weldment 18-3
 - protector spray, battery terminal 18-3
 - puller
 - bearing 18-3
 - drive clutch 18-3
 - drive clutch hub 18-3
 - driven clutch cam 18-3
 - flywheel 18-5
 - seal 18-5
 - pulley
 - clutch 12-3
 - starter-generator 7-11
 - v-belt 7-11
 - pump
 - fuel 10-3
 - push rod 8-9, 9-7
- ## R
- rack and pinion drag link 6-7
 - rack guide pressure spring 6-7
 - rack, steering 6-7
 - ratchet, park brake 5-3
 - reamer, valve guide 18-7
 - rear body 1-23
 - rear spring shackle 6-15
 - receptacle 14-9
 - receptacle backing plate 14-9
 - receptacle, AC cord 17-11
 - receptacle, accessory 4-15, 4-17
 - receptacle, battery charger 14-9
 - rectifier diode 17-5
 - rectifier with heatsink 17-3, 17-7, 17-9, 17-11
 - regulator, voltage 7-9
 - relay 4-7, 17-3, 17-7, 17-9, 17-11
 - relay mounting bracket 17-9
 - relay, 12-volt 4-5
 - relay, 48V 4-7, 17-7
 - relay, 48-volt 17-5
 - relay, brake, kit, 12-volt 4-5
 - remover, bearing and oil seal 18-3
 - resistor assembly 14-13
 - retainer
 - accelerator pedal spring 5-5, 5-7
 - bearing 15-3
 - brake shoe 5-11
 - cable 1-23, 1-25, 13-5
 - headlight 4-3, 7-7
 - shock absorber cushion 6-15
 - spring 6-15
 - spring (drive clutch) 12-3
 - valve spring 8-9, 9-7
 - retaining ring 6-5
 - retaining ring pliers 18-5
 - return spring bumper 5-5, 5-7
 - reverse buzzer 4-11, 4-13
 - rigging, brush 15-3
 - rim, wheel 2-3
 - ring
 - C-type stop 6-7
 - piston 8-13, 9-11
 - retaining 6-5, 7-9, 12-3, 12-9, 13-3
 - snap 6-7, 8-9, 8-13, 9-7, 9-11
 - spiral backup 12-3
 - synchronizer 13-9
 - Rivet, Removable 1-3, 4-15, 4-17
 - rock guard 13-19, 16-5
 - rocker arm 8-9, 9-7
 - rocker case 8-9, 9-7
 - rocker case gasket 8-9, 9-7
 - rocker shaft 8-9, 9-7
 - rocker switch 14-3
 - rocker switch (lights) 4-5, 4-7
 - rod
 - accelerator 5-9
 - accelerator pivot 5-5, 5-7
 - connecting 8-13, 9-11
 - crankshaft 8-13, 9-11
 - equalizer 5-13
 - hill brake 5-3
 - link 1-31
 - push 8-9, 9-7
 - shift 13-9
 - RPM limiter 8-5, 9-5
 - RPM limiter bracket 8-5, 9-5
 - RPM limiter damper 8-5, 9-5
 - RPM limiter mount band 8-5, 9-5
 - rubber bumper 1-17
- ## S
- safety first card 18-5
 - screen, oil filter 8-11, 9-9
 - screw, valve clearance adjuster 18-7
 - seal
 - crankshaft 8-11
 - intake 10-17
 - lip 16-3
 - oil 8-9, 8-13, 9-7, 9-9, 9-11, 13-7, 13-9, 13-11, 13-17, 16-3
 - steering pinion dust 6-7
 - vertical socket dust 6-7
 - seal puller 18-5
 - sealant 13-7, 16-3
 - seat
 - spring 8-9, 9-7
 - valve 8-7, 9-13
 - seat back, beige 1-29
 - seat back, gray 1-29
 - seat back, white 1-29
 - seat bottom assembly 1-27
 - seat bottom cover 1-27
 - seat cover, vinyl 1-27
 - seat cover, white 1-27
 - seat foam 1-27
 - seat gasket 1-27
 - seat support 1-29
 - seat support cross brace 1-29

INDEX

- seat, bearing 6-5
- sending unit, fuel gauge 10-5
- sensor, motor speed 15-3, 15-5
- sensor, oil level 8-11, 9-9
- sensor, speed 15-3
- set, brush and screw 7-11
- set, pole 7-11
- shackle, rear spring 6-15
- shaft
 - counterbalance guide 8-13, 9-11
 - drive selector 13-7, 13-13
 - input 16-3
 - intermediate 16-3
 - rocker 8-9, 9-7
 - steering column 6-5
 - transmission 13-9, 13-15
- shaft, reverse gear 13-15
- shaft, secondary
 - transmission 13-15
- shield, governor 10-11
- shift fork 13-9, 13-15
- shift lever 13-7, 13-13
- shift rod 13-9
- shifter base, FNR 13-3
- shifter bracket 13-5
- shim, camshaft 9-9
- shim, crankshaft 8-13, 9-11
- shock absorber 6-11
- shock absorber (rear) 6-15
- shock absorber cushion 6-15
- shock absorber cushion retainer 6-15
- shoe retainer kit 5-11
- shoe, brake 5-11
- shroud 9-3
- shroud, engine 8-3, 9-3
- shroud, fan 8-3, 9-3
- side bar 1-21
- signal, turn 4-9
- sleeve
 - delta A-plate 6-11
 - governor 13-9
 - park brake rod 5-3
 - synchronizer 13-9
- snap ring 6-7, 8-9, 8-13, 9-7, 9-11
- snubber bracket 8-15, 9-15
- snubber, inner frame 8-15, 9-15
- socket 6-7
- solenoid 14-13
- solenoid, 12-volt 7-9
- spacer
 - accelerator pivot rod 5-5, 5-7
 - key switch 4-15
 - overload bumper 6-15
 - park brake 5-3
- spark plug 8-5, 9-5
- spark plug cap 8-5
- speed controller
 - CE 14-13
 - IQ 14-13
- speed controller cover 14-13
- speed sensor 15-3, 15-5
- speed sensor magnet 15-3, 15-5
- speed sensor, motor 15-3, 15-5
- spindle 6-13
- spindle and hub 6-13
- spiral backup ring 12-3
- spray, battery terminal protector 18-3
- spring 1-31
 - accelerator return 5-5, 5-7
 - brake 5-11
 - brake return 5-13
 - brush 7-11, 15-3, 15-5
 - compression 10-17
 - drive button 12-3
 - drive clutch 12-3
 - driven clutch 12-9
 - engine valve 8-9
 - extension 1-31
 - extension return 10-17
 - forward/reverse cam 13-3
 - leaf 6-15
 - park brake torsion 5-3
 - rack guide pressure 6-7
 - shifter 13-9
 - steering shaft compression 6-5
 - synchronizer 13-9
 - throttle return 10-11, 10-13
 - valve 9-7
- spring cup 5-5, 5-7
- spring mounting plate 6-9
- spring retainer 6-15
- spring, leaf 6-9
- spur gear 8-13, 9-11, 13-9
- stand-offs, plastic 17-3
- starter/generator (cw) (model G425419) 7-11
- starter/generator belt 7-13, 7-15, 12-3
- starter/generator brush cover kit 7-11
- starter/generator brush plate 7-11
- starter/generator brush spring 7-11
- starter/generator brush terminal 7-11
- starter/generator frame and field 7-11
- starter/generator mounting bracket 7-13
- starter/generator pulley 7-11
- stator shell and winding 15-3
- steel bushing 1-33, 6-9, 6-15
- steel pressure relief ball 8-7, 9-13
- steering column 6-5
- steering column bearing press tool 18-7
- steering column cover 4-9
- steering column retaining ring tool 18-7
- steering gear box 6-7
- steering pinion 6-7
- steering pinion dust seal 6-7
- steering rack 6-7
- steering shaft assembly 6-5
- steering shaft compression spring 6-5
- steering wheel 6-3
- steering wheel center 6-3
- steering wheel puller tool 18-7
- stem, valve 2-3
- stiffener, bed support 1-33
- stiffener, flywheel side 8-15, 9-15
- stiffener, PTO side 9-15
- strap, A-plate 6-11
- strap, fuel tank 10-3
- strobe light 4-25, 4-27, 4-29
- strobe light lens 4-25, 4-27, 4-29
- stud 8-15, 9-15
 - lug 6-13, 13-11, 13-17, 16-3
- stud, ball 7-9, 13-3, 13-7, 13-13
- support
 - bed 1-29
 - brush guard 6-9
 - cowl 1-3
 - hinge 1-33
 - latch link 1-31
 - seat 1-29
- support yoke (steering) 6-7
- support, front body 1-23, 1-25
- support, seat 1-29
- suppressor, voltage 4-5, 17-7, 17-9, 17-11
- switch plate cover 4-25, 4-27, 4-29
- switch
 - four-position 17-9, 17-11
 - key 4-13, 4-15, 4-17
 - light 4-15, 4-17
 - light rocker 4-5, 4-7
 - limit 4-5, 4-7, 13-3
 - rocker 14-3
 - Tow/Run 14-3
 - turn signal 4-9
- switch assembly 4-25, 4-27, 4-29
- switch rubber boot 14-3
- synchro gear 13-9
- synchronizer clutch hub 13-9
- synchronizer insert 13-9
- synchronizer sleeve 13-9
- synchronizer spring 13-9
- synchronizer, complete 13-15
- system, exhaust 11-3, 11-5

T

- 12-volt battery 7-17
- 12-volt solenoid 7-9
- tachometer 18-7
- tail light bulb 4-35
- taillight 4-35
- taillight gasket 4-35

INDEX

- taillight kit 4-35
 - taillight lens 4-35
 - taligate 1-31
 - tank, fuel 10-5
 - tape, non-skid 1-21
 - tappet 8-11
 - terminal block 4-5, 4-7, 14-13
 - terminal, 1/4 quick-disconnect 4-21
 - tester, continuity 18-5
 - thermometer, battery 18-3
 - thread-forming grease fitting 6-7, 6-13
 - throttle return spring 10-11, 10-13
 - throttle spring return bracket 10-11, 10-13
 - thrust bearing 6-9
 - thrust plate 13-9, 13-11
 - tie rod 6-11
 - tie rod end 6-11
 - tie wrap 4-9, 4-21, 4-27, 4-29, 4-33, 6-7, 7-9, 14-3, 14-13
 - tilt bed catch 1-31
 - tilt latch 1-31
 - tire 2-3
 - tool
 - accelerator pedal adjustment 18-3
 - brake adjustment 18-3
 - brake cable release 18-3
 - charger bezel 18-3
 - clutch cam installation 18-3
 - drive clutch holder 18-3
 - governor shaft installation 18-5
 - steering column bearing press 18-7
 - steering column retaining ring 18-7
 - steering wheel puller 18-7
 - transaxle axle seal 18-7
 - transaxle pinion seal 18-7
 - transmission 18-7
 - tool kit, clutch 18-3
 - touch-up paint 18-5
 - Tow/Run switch 14-3
 - Tow/Run switch bracket 14-3
 - transaxle (Electric Vehicle) 16-3
 - transaxle axle seal tool 18-7
 - transaxle Graziano (gasoline vehicle), unitized 13-13
 - transaxle guard 13-19, 16-5
 - transaxle pinion seal tool 18-7
 - transaxle, Kawasaki (Gasoline Vehicle) 13-7
 - transformer 17-3
 - transformer, battery charger 17-5, 17-7, 17-9, 17-11
 - transmission cable 13-5
 - transmission secondary shaft 13-15
 - transmission shaft 13-9, 13-15
 - transmission tool 18-7
 - tube
 - axle 13-11, 13-17, 16-3
 - crankcase vent 10-11, 10-13
 - oil filler 8-3, 9-3
 - Tuflok 1-3, 4-15, 4-17
 - tune-up kit 18-7
 - turn signal 4-9
 - turn signal conversion kit 4-9
 - turn signal lens 4-3, 7-7
 - turn signal socket and lamp 4-9
- ## U
- U-bolt 6-15
 - unitized transaxle Graziano 13-13
 - upper delta clevis 6-9
 - urethane bushing 1-33, 6-9, 6-11, 6-15
- ## V
- valve
 - choke 10-17
 - exhaust 8-9, 9-7
 - fuel pickup tube 10-5
 - intake 8-9, 9-7
 - reed 8-9, 9-7
 - valve clearance adjuster screw 18-7
 - valve guide 9-7
 - valve guide reamer 18-7
 - valve guide, intake 8-9, 9-7
 - valve seat 8-7, 9-13
 - valve seat cutter 18-7
 - valve seat cutter guide 18-7
 - valve seat t-wrench 18-7
 - valve spring 9-7
 - valve spring compressor 18-7
 - valve spring retainer 8-9, 9-7
 - valve stem 2-3
 - v-belt 7-13, 7-15, 12-3
 - vent barb 10-3, 10-5
 - vertical socket dust seal 6-7
 - volt ohm meter 18-7
 - voltage limiter 4-5, 4-7, 4-23
 - voltage regulator 7-9
 - voltage suppressor 4-5, 17-7, 17-9, 17-11
- ## W
- warning light, low oil 4-13, 4-15
 - wear pad 1-23, 1-25
 - wedge, bearing puller 18-3
 - weight
 - clutch 12-3
 - counterbalance 8-13, 9-11
 - secondary clutch 12-3
 - weldment
 - press 18-3
 - wheel cover 2-5
 - wheel rim 2-3
 - wheel, steering 6-3
 - wire harness 4-21, 4-25, 4-27, 4-35, 14-7
 - wire harness, gasoline 7-5
 - wire harness, headlight 4-5, 4-7
 - wire harness, lighting 4-7
 - wiring, charger 17-3
 - woodruff key 13-7
 - wrap, tie 4-9, 4-21, 4-27, 4-29, 4-33, 6-7, 7-9, 14-3, 14-13
- ## Y
- yoke, gear 18-5
 - yoke, support (steering) 6-7



Club Car, Inc.
P.O. Box 204658
Augusta, GA 30917-4658
USA

Web www.clubcar.com
Phone 1.706.863.3000
1.800.ClubCar
Int'l +1 706.863.3000
Fax 1.706.863.5808